

AN BOLTS

AN Bolts

- Made of high-strength type 4037 or 8740 alloy steel
- Centerless ground & threaded
- Minimum tensile strength 125,000 PSI
- Cadmium plated per spec QQ-P-416A, Type II, Class 3
- 431 Stainless steel (CRES)

ANX(C or H)-X(A)

AN = DIAMETER

H = DRILLED HEAD

C = CORROSION RESISTANT STEEL

A = UNDRILLED SHANK

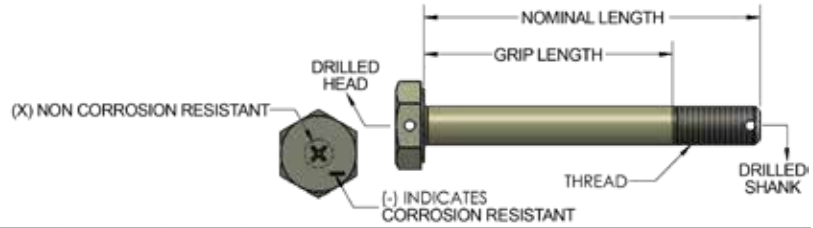

HA

FOR UNDRILLED
ADD THE LETTER "A"
EXAMPLE:
AN6 - 10A

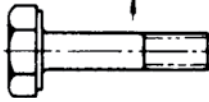

UNDRILLED

FOR DRILLED SHANK
NO LETTER
EXAMPLE!
AN6 - 10



SHANK ONLY
DRILLED

FOR DRILLED HEAD
ADD "H" AND "A"
EXAMPLE:
AN6H-10A

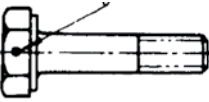

HEAD ONLY
DRILLED

FOR DRILLED HEAD AND
SHANK
ADD "H" ONLY
EXAMPLE:
AN6H-10

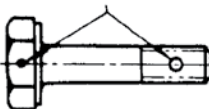

BOTH HEAD AND
SHANK DRILLED

Bolts are sold "EACH"		AN3					AN4				
ALL BOLTS		Grip Length	Cadmium Plated AN3 (10-32)		Stainless AN3C (10-32)		Grip Length	Cadmium Plated AN4 (1/4-28)		Stainless AN4C (1/4-28)	
Dash No.	Nominal Length		Drilled Price	Undrilled "A" Price	Drilled Price	Undrilled "A" Price		Drilled Price	Undrilled "A" Price	Drilled Price	Undrilled "A" Price
-3	15/32	1/16	\$0.48	\$0.13	\$0.82	\$0.49	1/16	\$0.56	\$0.19	\$7.99	\$2.18
-4	17/32	1/8	\$0.79	\$0.13	\$1.43	\$0.48	1/16	\$0.56	\$0.22	\$1.17	\$0.75
-5	21/32	1/4	\$0.47	\$0.13	\$1.34	\$0.49	3/16	\$0.54	\$0.23	\$1.06	\$0.72
-6	25/32	3/8	\$0.91	\$0.15	\$1.63	\$0.83	5/16	\$0.58	\$0.24	\$1.67	\$0.76
-7	29/32	1/2	\$0.77	\$0.16	\$1.43	\$0.65	7/16	\$0.94	\$0.23	\$1.36	\$0.82
-10	1-1/32	5/8	\$0.78	\$0.23	\$1.50	\$0.84	9/16	\$0.66	\$0.28	\$2.81	\$1.07
-11	1-5/32	3/4	\$0.57	\$0.27	\$1.30	\$0.78	11/16	\$0.68	\$0.39	\$2.09	\$1.15
-12	1-9/32	7/8	\$1.00	\$0.30	\$1.67	\$0.76	13/16	\$1.00	\$0.34	\$1.99	\$1.39
-13	1-13/32	1	\$0.62	\$0.30	\$1.53	\$0.74	15/16	\$0.77	\$0.38	\$1.59	\$1.47
-14	1-17/32	1-1/8	\$0.90	\$0.30	\$1.93	\$1.14	1-1/16	\$0.77	\$0.36	\$1.84	\$1.31
-15	1-21/32	1-1/4	\$0.91	\$0.37	\$1.88	\$0.81	1-3/16	\$1.02	\$0.48	\$1.86	\$1.50
-16	1-25/32	1-3/8	\$0.95	\$0.36	-	\$1.22	1-5/16	\$0.89	\$0.59	-	\$1.55
-17	1-29/32	1-1/2	\$0.70	\$0.34	\$4.35	\$0.89	1-7/16	\$0.89	\$0.62	\$5.35	\$1.03
-20	2-1/32	1-5/8	\$0.69	\$0.42	\$5.35	\$1.07	1-9/16	\$0.86	\$0.63	\$2.65	\$1.20
-21	2-5/32	1-3/4	\$1.73	\$0.42	-	\$1.19	1-11/16	\$0.95	\$0.54	-	\$1.44
-22	2-9/32	1-7/8	\$0.82	\$0.48	-	\$1.43	1-13/16	\$1.15	\$0.56	-	\$1.53
-23	2-13/32	2	\$0.83	\$0.46	-	\$1.40	1-15/16	\$1.14	\$0.62	-	\$1.17
-24	2-17/32	2-1/8	\$0.82	\$0.50	-	\$2.93	2-1/16	\$0.96	\$0.64	-	\$2.19
-25	2-21/32	2-1/4	\$0.99	\$0.53	-	\$1.52	2-3/16	\$1.00	\$0.53	-	\$4.90
-26	2-25/32	2-3/8	\$1.20	\$0.58	-	\$5.45	2-5/16	\$1.19	\$0.73	-	\$2.75
-27	2-29/32	2-1/2	\$0.99	\$0.57	-	\$8.70	2-7/16	\$1.06	\$0.75	-	\$3.75
-30	3-1/32	2-5/8	\$0.90	\$0.64	-	\$3.35	2-9/16	\$1.14	\$0.79	-	\$3.76
-31	3-5/32	2-3/4	\$1.59	\$0.56	-	-	2-11/16	\$1.70	\$0.80	-	-
-32	3-9/32	2-7/8	\$0.87	\$0.79	-	-	2-13/16	\$1.14	\$0.83	-	-
-33	3-13/32	3	\$1.05	\$0.78	-	-	2-15/16	\$1.27	\$0.88	-	-
-34	3-17/32	3-1/8	\$1.19	\$0.68	-	-	3-1/16	\$1.31	\$0.93	-	-
-35	3-21/32	3-1/4	\$1.86	\$1.26	-	\$5.55	3-3/16	\$1.21	\$0.88	-	-
-36	3-25/32	3-3/8	\$1.18	\$0.88	-	-	3-5/16	\$1.30	\$0.94	-	-
-37	3-29/32	3-1/2	\$1.44	\$0.97	-	-	3-7/16	\$1.34	\$1.21	-	-
-40	4-1/32	3-5/8	\$1.34	\$0.94	-	-	3-9/16	\$1.61	\$1.27	-	-
-41	4-5/32	3-3/4	\$1.42	\$1.06	-	-	3-11/16	\$1.69	\$1.42	-	-
-42	4-9/32	3-7/8	\$1.63	\$1.05	-	-	3-13/16	\$1.72	\$1.44	-	-
-43	4-13/32	4	-	\$1.26	-	-	3-15/16	\$1.94	\$1.80	-	-
-44	4-17/32	4-1/8	\$3.90	\$1.68	-	-	4-1/16	\$0.54	\$1.47	-	-
-45	4-21/32	4-1/4	\$1.55	\$1.48	-	-	4-3/16	\$2.05	\$1.55	-	-
-46	4-25/32	4-3/8	\$5.35	\$4.45	-	-	4-5/16	\$1.95	\$1.71	-	-
-47	4-29/32	4-1/2	\$3.35	\$1.46	-	-	4-7/16	\$2.13	\$1.85	-	-
-50	5-1/32	4-5/8	\$12.95	\$9.87	-	-	4-9/16	\$5.45	\$3.85	-	-
-51	5-5/32	4-3/4	\$10.50	\$9.60	-	-	4-11/16	\$8.60	\$4.35	-	-
-52	5-9/32	4-7/8	-	\$10.50	-	-	4-13/16	\$9.50	\$5.90	-	-
-53	5-13/32	5	-	-	-	-	4-15/16	-	\$6.80	-	-
-54	5-17/32	5-1/8	\$11.50	\$9.99	-	-	5-1/16	-	\$9.83	-	-
-55	5-21/32	5-1/4	-	\$12.50	-	-	5-3/16	\$9.74	\$6.95	-	-
-56	5-25/32	5-3/8	\$12.25	\$11.75	-	-	5-5/16	\$9.70	\$7.50	-	-
-57	5-29/32	5-1/2	-	\$11.60	-	-	5-7/16	\$9.95	\$9.94	-	-
-60	6-1/32	5-5/8	\$34.50	\$13.75	-	-	5-9/16	\$9.68	\$13.90	-	-

Quantity discount on AN4 bolts - 15% discount on qty of 50-99 • 20% discount on qty of 100+

AN BOLTS



AN BOLT GAUGE

Easy to use bolt gauge quickly and accurately identifies the diameters and lengths of "AN" bolts ranging from AN3-3 to AN10-50. There is also a handy reference guide on the back to help you identify the specific type of bolt from its head markings (symbolology) and pre-drilled holes. 1 lbs (0.5Kg) shipping weight.
Automatically sizes all AN bolts up to 5/8" diameter and 5 inches long.

P/N 04-05400..... \$10.50

AN5 BOLTS AND AN6 BOLTS

Hex head aircraft bolts are made of high-strength type 4037 or 8740 alloy steel (type 8740 is most commonly used). The bolts are centerless ground and threaded after heat treatment. Minimum tensile strength 125,000 PSI. Cadmium plated per specification QQ-P-416A, Type II, Class 3.

Bolts are sold "EACH"			AN5				AN6				
ALL BOLTS			Cadmium Plated AN5 (5/16-24)		Stainless AN5C (5/16-24)		Grip Length	Cadmium Plated AN6 (3/8-24)		Stainless AN6C (3/8-24)	
Dash No.	Nominal Length	Grip Length	Drilled Price	Undrilled "A" Price	Drilled Price	Undrilled "A" Price		Drilled Price	Undrilled "A" Price	Drilled Price	Undrilled "A" Price
-4	19/32	1/16	\$0.78	\$0.44	\$8.87	\$2.46	1/16	\$1.55	\$0.87	-	-
-5	23/32	3/16	\$0.69	\$0.47	\$3.80	\$1.38	1/16	\$1.48	\$0.81	-	\$3.40
-6	27/32	5/16	\$0.99	\$0.41	\$4.50	\$2.46	3/16	\$1.02	\$0.60	\$39.95	\$5.70
-7	31/32	7/16	\$0.80	\$0.47	\$8.99	\$2.15	5/16	\$0.98	\$0.60	\$18.50	\$3.40
-10	1-3/32	9/16	\$0.84	\$0.48	-	\$2.10	7/16	\$0.96	\$0.65	-	\$3.45
-11	1-7/32	11/16	\$1.56	\$0.48	-	\$1.84	9/16	\$0.96	\$0.66	\$11.50	\$3.25
-12	1-11/32	13/16	\$1.81	\$0.55	\$28.50	\$2.45	11/16	\$1.51	\$0.67	\$27.50	\$3.85
-13	1-15/32	15/16	\$0.94	\$0.61	-	\$2.43	13/16	\$1.14	\$0.99	-	\$3.60
-14	1-19/32	1-1/16	\$1.56	\$0.56	-	\$2.38	15/16	\$1.11	\$0.97	\$7.50	\$4.55
-15	1-23/32	1-3/16	\$0.99	\$0.74	-	\$3.99	1-1/16	\$1.71	\$1.09	-	\$4.98
-16	1-27/32	1-5/16	\$1.07	\$0.74	-	-	1-3/16	\$1.34	\$1.23	\$13.60	\$2.80
-17	1-31/32	1-7/16	\$1.07	\$0.69	-	\$2.48	1-5/16	\$1.66	\$0.86	-	\$4.45
-20	2-3/32	1-9/16	\$1.34	\$0.76	-	\$7.92	1-7/16	\$1.28	\$0.95	-	-
-21	2-7/32	1-11/16	\$1.12	\$0.74	-	\$1.81	1-9/16	\$2.30	\$1.10	-	-
-22	2-11/32	1-13/16	\$2.09	\$0.82	-	-	1-11/16	\$1.43	\$0.98	-	-
-23	2-15/32	1-15/16	\$1.16	\$0.79	-	-	1-13/16	\$1.36	\$0.97	-	-
-24	2-19/32	2-1/16	\$1.25	\$0.92	-	-	1-15/16	\$1.50	\$1.15	-	-
-25	2-23/32	2-3/16	\$1.22	\$0.95	-	\$18.50	2-1/16	\$1.77	\$1.24	-	-
-26	2-27/32	2-5/16	\$1.18	\$0.86	-	\$6.50	2-3/16	\$1.79	\$1.30	-	-
-27	2-31/32	2-7/16	\$1.23	\$0.86	-	\$12.60	2-5/16	\$1.97	\$1.44	-	-
-30	3-3/32	2-9/16	\$1.94	\$0.84	-	-	2-7/16	\$1.91	\$1.43	-	-
-31	3-7/32	2-11/16	\$1.65	\$0.83	-	-	2-9/16	\$1.97	\$1.80	-	-
-32	3-11/32	2-13/16	\$2.39	\$0.87	-	-	2-11/16	\$1.80	\$1.57	-	-
-33	3-15/32	2-15/16	\$1.24	\$0.91	-	-	2-13/16	\$1.91	\$1.47	-	-
-34	3-19/32	3-1/16	\$1.64	\$0.93	-	-	2-15/16	\$2.04	\$1.68	-	-
-35	3-23/32	3-3/16	\$1.53	\$1.19	-	-	3-1/16	\$1.98	\$1.61	-	-
-36	3-27/32	3-5/16	\$1.76	\$1.41	-	-	3-3/16	\$2.17	\$1.82	-	-
-37	3-31/32	3-7/16	\$1.86	\$1.57	-	-	3-5/16	\$3.35	\$1.59	-	-
-40	4-3/32	3-9/16	\$1.88	\$1.41	-	-	3-7/16	\$2.74	\$1.83	-	-
-41	4-7/32	3-11/16	\$1.92	\$1.68	-	-	3-9/16	\$3.35	\$2.05	-	-
-42	4-11/32	3-13/16	-	\$2.16	-	-	3-11/16	\$5.00	\$2.61	-	-
-43	4-15/32	3-15/16	\$2.40	\$2.45	-	-	3-13/16	\$4.70	\$3.35	-	-
-44	4-19/32	4-1/16	-	\$1.97	-	-	3-15/16	\$4.35	\$2.41	-	-
-45	4-23/32	4-3/16	\$2.75	\$2.12	-	-	4-1/16	\$5.60	\$3.95	-	-
-46	4-27/32	4-5/16	\$2.78	\$2.42	-	-	4-3/16	\$3.55	\$3.60	-	-
-47	4-31/32	4-7/16	\$3.50	\$2.43	-	-	4-5/16	\$4.60	\$5.35	-	-
-50	5-3/32	4-9/16	\$5.35	\$4.80	-	-	4-7/16	\$11.50	\$9.95	-	-
-51	5-7/32	4-11/16	\$9.97	\$7.90	-	-	4-9/16	\$11.70	\$11.50	-	-
-52	5-11/32	4-13/16	\$9.98	\$9.50	-	-	4-11/16	\$12.50	\$12.65	-	-
-53	5-15/32	4-15/16	\$9.88	\$10.99	-	-	4-13/16	\$11.85	\$11.65	-	-
-54	5-19/32	5-1/16	\$9.55	\$10.75	-	-	4-15/16	\$11.75	\$11.63	-	-
-55	5-23/32	5-3/16	\$9.75	\$9.69	-	-	5-1/16	\$11.50	\$11.87	-	-
-56	5-27/32	5-5/16	\$8.86	\$9.93	-	-	5-3/16	\$10.70	\$10.65	-	-
-57	5-31/32	5-7/16	\$12.75	\$16.75	-	-	5-5/16	\$10.93	\$11.75	-	-
-60	6-3/32	5-9/16	\$10.75	\$9.99	-	-	5-7/16	\$11.68	\$11.50	-	-

HA

AN BOLTS

USE REFERENCE CHART

Bolt Size	AN960 Flat Washer	AN970 Lg. Area Flat Washer	AN365 Nylon Insert Locknut	AN310 Castle Nut	AN380 Cotter Pin
AN3	-10	-3	-1032	-3	-2-2 or longer
AN4	-416	-4	-428	-4	-25-2 or longer
AN5	-516	-5	-524	-5	-25-3
AN6	-616	-6	-624	-6	-3-3 or longer
AN7	-716	-7	-720	-7	-3-3 or longer
AN8	-816	-8	-820	-8	-3-4 or longer

SAMPLE PART NUMBERS

AN3-4	Cad-plated, drilled shank
AN3-4A	Cad-plated, undrilled
AN3C-4	Stainless steel, drilled shank
AN3C-4A	Stainless steel, undrilled

TOBACCO BAGS



Cloth bags for holding hardware as it is removed from the aircraft. Set of 25.

P/N 04-05310\$18.85

NOTICE - Aircraft Spruce & Specialty Company is committed to supplying only top quality aircraft grade hardware. We receive our hardware certified to applicable AN, MS, or NAS specifications from our suppliers, on certain items it is necessary for us to accept hardware without certifiable traceability in order to continue supplying that particular part number. These hardware items are designated as "surplus" in the product description.

HA

AN7 AND AN8 BOLTS

Hex head aircraft bolts are made of high-strength type 4037 or 8740 alloy steel (type 8740 is most commonly used). The bolts are centerless ground and threaded after heat treatment. Minimum tensile strength 125,000 PSI. Cadmium plated per specification QQ-P-416A, Type II, Class 3.

Bolts are sold "EACH"			AN7				AN8			
ALL BOLTS			Cadmium Plated AN7 (7/16-20)		Stainless AN7C (7/16-20)		Cadmium Plated AN8 (1/2-20)			
Dash	Nominal Length	Grip Length	Drilled Price	Undrilled "A" Price	Drilled Price	Undrilled "A" Price	Grip Length	Drilled Price	Undrilled "A" Price	
-5	23/32	1/16	--	\$1.62	-	-	-	-	-	
-6	27/32	3/16	\$4.99	\$3.40	-	-	1/16	\$10.50	\$4.35	
-7	31/32	5/16	--	\$1.15	-	-	3/16	\$6.50	\$1.68	
-10	1-3/32	7/16	\$2.18	\$1.14	-	-	5/16	--	\$3.75	
-11	1-7/32	9/16	--	\$1.38	-	-	7/16	\$2.15	\$2.02	
-12	1/11/32	11/16	\$1.79	\$1.78	-	-	9/16	\$4.40	\$2.01	
-13	1-15/32	13/16	\$1.99	\$1.78	-	-	11/16	\$3.35	\$2.08	
-14	1-19/32	15/16	\$2.76	\$1.37	-	-	13/16	\$3.70	\$2.25	
-15	1-23/32	1-1/16	\$2.55	\$1.74	-	-	15/16	\$3.55	\$2.08	
-16	1-27/32	1-3/16	\$3.35	\$1.62	-	-	1-1/16	\$4.35	\$2.28	
-17	1-31/32	1-5/16	\$3.35	\$1.68	-	-	1-3/16	\$3.80	\$2.29	
-20	2-3/32	1-7/16	\$2.48	\$1.43	-	-	1-5/16	\$5.35	\$3.60	
-21	2-7/32	1-9/16	\$4.40	\$1.74	-	-	1-7/16	\$3.70	\$2.46	
-22	2-11/32	1-11/16	\$2.83	\$2.02	-	-	1-9/16	\$3.90	\$2.58	
-23	2-15/32	1-13/16	--	\$2.31	-	-	1-11/16	\$4.95	\$2.52	
-24	2-19/32	1-15/16	\$2.69	\$2.65	-	-	1-13/16	\$5.35	\$3.35	
-25	2-23/32	2-1/16	\$2.85	\$2.24	-	-	1-15/16	\$3.90	\$3.95	
-26	2-27/32	2-3/16	\$3.35	\$2.21	-	-	2-1/16	\$4.45	\$2.64	
-27	2-31/32	2-5/16	\$3.35	\$2.50	-	-	2-3/16	\$5.35	\$3.35	
-30	3-3/32	2-7/16	--	\$2.32	-	-	2-5/16	\$4.85	\$2.66	
-31	3-7/32	2-9/16	\$3.65	\$3.35	-	-	2-7/16	\$4.55	\$3.35	
-32	3-11/32	2-11/16	\$3.35	\$2.93	-	-	2-9/16	\$3.75	\$3.35	
-33	3-15/32	2-13/16	\$3.95	\$2.56	-	-	2-11/16	\$4.53	\$3.50	
-34	3-19/32	2-15/16	\$3.45	\$3.85	-	-	2-13/16	\$6.90	\$3.65	
-35	3-23/32	3-1/16	\$5.00	\$3.35	-	-	2-15/16	--	\$4.35	
-36	3-27/32	3-3/16	\$4.35	\$4.35	-	-	3-1/16	\$4.35	\$3.35	
-37	3-31/32	3-5/16	\$3.85	\$2.65	-	-	3-3/16	\$4.43	\$3.99	
-40	4-3/32	3-7/16	\$4.35	\$4.40	-	-	3-5/16	--	\$6.85	
-41	4-7/32	3-9/16	--	--	-	-	3-7/16	\$4.35	\$4.35	
-42	4-11/32	3-11/16	\$5.35	\$4.35	-	-	3-9/16	\$4.40	--	
-43	4-15/32	3-13/16	\$3.95	\$4.45	-	-	3-11/16	\$4.75	\$4.50	
-44	4-19/32	3-15/16	\$5.35	\$4.70	-	-	3-13/16	\$5.65	\$5.55	
-45	4-23/32	4-1/16	\$3.65	\$7.50	-	-	3-15/16	\$5.90	\$4.85	
-46	4-27/32	4-3/16	\$7.50	\$4.50	-	-	4-1/16	--	--	
-47	4-31/32	4-5/16	\$4.60	\$5.35	-	-	4-3/16	\$7.50	--	
-50	5-3/32	4-7/16	\$15.95	\$13.95	-	-	4-5/16	\$21.50	\$16.50	
-51	5-7/32	4-9/16	--	--	-	-	4-7/16	--	\$13.46	
-52	5-11/32	4-11/16	\$13.90	\$13.80	-	-	4-9/16	\$16.50	\$15.50	
-53	5-15/32	4-13/16	--	--	-	-	4-11/16	\$21.80	--	
-54	5-19/32	4-15/16	-	--	-	-	4-13/16	--	\$17.62	
-55	5-23/32	5-1/16	--	\$12.50	-	-	4-15/16	\$21.50	--	
-56	5-27/32	5-3/16	\$16.75	\$14.93	-	-	5-1/16	\$14.50	\$16.90	
-57	5-31/32	5-5/16	--	\$13.90	-	-	5-3/16	\$13.95	--	
-60	6-3/32	5-7/16	\$15.75	\$13.94	-	-	5-5/16	\$22.50	--	

DRILLED HEAD, UNDRILLED SHANK

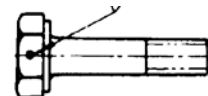

AN3 Ea.

H4A	\$0.57
H5A	\$0.52
H6A	\$0.48
H10A	\$0.58
H12A	\$0.60
H13A	\$0.76
H15A	\$0.72

AN4 Ea.

H3A	\$0.53
H4A	\$0.58
H5A	\$0.91
H6A	\$0.54
H7A	\$0.56
H12A	\$0.72
H13A	\$0.69
H14A	\$0.78
H16A	\$1.40
H21A	\$1.26
H26A	\$1.00
H30A	\$1.13
H32A	\$1.92

AN5 Ea.

H6A	\$0.95
H12A	\$0.86
H13A	\$1.40
H16A	\$1.16
H17A	\$1.45
H20A	\$1.19
H31A	\$3.89
H33A	-----

AN6 Ea.

H11A	\$1.54
H14A	\$1.50
H20A	\$8.85
H31A	\$4.90
H32A	\$3.90
H34A	\$2.95
H37A	\$6.60
H40A	\$10.95
H41A	\$10.75
H43A	\$8.60
H45A	\$8.70
H46A	\$11.50
H50A	\$12.50

AN8 Ea.

H7A	\$7.50
-----	-------	--------

EYE BOLTS

AN42 - AN46 EYE BOLTS



Eye bolts are special purpose bolts to be used where external tension loads are to be applied. The eye is designed for attachment of such devices as a turnbuckle fork, a clevis or a cable shackle. Manufactured and plated in same manner as AN3 - AN8 bolts. Minimum tensile strength 125, 000 PSI . Eye bolts will be furnished with either drilled or undrilled shank subject to stock on hand. Add letter "A" after dash number for undrilled shank.

Bolts are sold "EACH"		AN42B			AN43B		
ALL BOLTS		Shank 3/16" / Hole 3/16" / Thread 10-32			Shank 1/4" / Hole 3/16" / Thread 1/4-28		
Dash No.	Nominal Length	Grip Length	Drilled Price	Undrilled "A" Price	Grip Length	Drilled Price	Undrilled "A" Price
-4	1/2	1/8	\$11.65	\$6.50	1/16	\$11.55	\$9.90
-5	5/8	1/4	\$23.50	\$12.65	3/16	\$8.99	\$12.50
-6	3/4	3/8	\$11.90	\$9.50	5/16	\$12.95	\$19.50
-7	7/8	1/2	\$30.50	\$6.50	7/16	\$9.50	\$12.50
-10	1	5/8	\$13.70	\$10.80	9/16	\$14.50	\$14.50
-11	1-1/8	3/4	\$12.50	\$21.70	11/16	\$24.50	\$11.50
-12	1-1/4	7/8	\$9.85	\$9.50	13/16	\$14.50	\$12.50
-13	1-3/8	1	\$15.90	\$13.90	15/16	\$17.60	\$16.55
-14	1-1/2	1-1/8	\$11.85	\$16.50	1-1/16	\$14.85	\$10.60
-15	1-5/8	1-1/4	\$14.70	\$11.50	1-3/16	\$17.50	\$13.50
-16	1-3/4	1-3/8	\$13.50	\$8.70	1-5/16	\$22.60	\$16.90
-17	1-7/8	1-1/2	\$14.95	\$17.50	1-7/16	\$48.50	\$13.50
-20	2	1-5/8	\$19.50	\$12.50	1-9/16	\$19.50	\$14.50
-21	2-1/8	1-3/4	\$13.50	\$26.50	1-11/16	---	\$14.95
-22	2-1/4	1-7/8	\$16.50	\$21.50	1-13/16	\$25.50	\$23.60
-23	2-3/8	2	\$15.90	\$13.50	1-15/16	\$18.60	\$22.60
-24	2-1/2	2-1/8	\$17.50	\$16.65	2-1/16	\$20.80	\$15.85
-25	2-5/8	2-1/4	---	\$14.55	2-3/16	\$21.50	\$18.50
-26	2-3/4	3-3/8	---	\$18.50	2-5/16	\$17.70	\$17.65
-27	2-7/8	2-1/2	---	\$19.75	2-7/16	---	\$17.50
-30	3	2-5/8	\$51.85	\$12.50	2-9/16	\$27.50	\$43.85

Bolts are sold "EACH"		AN44			AN45			
ALL BOLTS		Shank 5/16" / Hole 1/4" / Thread 5/16-24			Shank 05/16" / Hole 5/16" / Thread 5/16-24			
Dash No.	Nominal Length	Grip Length	Drilled Price	Undrilled "A" Price	Dash No.	Grip Length	Drilled Price	Undrilled "A" Price
-5	5/8	3/16	---	\$25.50	-4	1/16	\$16.90	---
-7	7/8	7/16	\$48.75	\$12.50	-5	3/16	---	\$13.55
-10	1	9/16	\$61.75	\$15.50	-6	5/16	\$17.50	\$12.85
-11	1-1/8	11/16	---	\$9.50	-7	7/16	\$18.80	\$19.50
-12	1-1/4	13/16	\$11.50	\$21.70	-10	9/16	---	\$15.50
-13	1-3/8	15/16	\$17.50	\$13.50	-12	13/16	\$23.50	\$18.95
-14	1-1/2	1-1/16	\$22.50	\$11.80	-13	15/16	\$21.60	\$23.50
-15	1-5/8	1-3/16	\$36.50	\$10.75	-14	1-1/16	\$19.85	\$23.50
-16	1-3/4	1-5/16	\$22.50	\$31.50	-15	1-3/16	\$30.95	\$21.55
-17	1-7/8	1-7/16	\$16.50	\$25.50	-16	1-5/16	---	---
-20	2	1-9/16	\$12.50	\$24.85	-17	1-7/16	---	\$29.90
-21	2-1/8	1-11/16	---	---	-20	1-9/16	\$29.50	\$23.50
-22	2-1/4	1-13/16	\$14.95	\$35.50	-21	1-11/16	---	\$21.50
-24	2-1/2	2-1/16	\$45.50	\$22.50	-23	1-15/16	---	---
-25	2-5/8	2-3/16	---	\$28.75	-24	2-1/16	\$30.50	---
-26	2-3/4	2-5/16	\$15.50	\$15.50	-25	2-3/16	---	---
-27	2-7/8	2-7/16	---	---	-26	2-5/16	---	---
-30	3	2-9/16	---	---	-27	2-7/16	\$31.50	\$27.50
					-30	2-9/16	\$22.99	---

Bolts are sold "EACH"		AN46		
ALL BOLTS		Shank 3/8" / Hole 3/8" / Thread 3/8-24		
Dash No.	Nominal Length	Grip Length	Drilled Price	Undrilled "A" Price
-5	5/8	1/16	---	---
-6	3/4	3/16	\$28.50	---
-7	7/8	5/16	\$11.50	\$28.80
-10	1	7/16	---	---
-12	1-1/4	11/16	---	---
-13	1-3/8	13/16	\$31.90	---
-14	1-1/2	15/16	---	\$29.50
-15	1-5/8	1-1/16	\$23.50	\$30.60
-16	1-3/4	1-3/16	\$73.75	---
-17	1-7/8	1-5/16	---	\$22.50
-20	2	1-7/16	\$16.70	---
-21	2-1/8	1-9/16	\$16.50	---
-22	2-1/4	1-11/16	---	\$24.95
-23	2-3/8	1-13/16	---	\$35.50
-25	2-5/8	2-1/16	\$45.75	\$26.50
-26	2-3/4	2-3/16	\$27.50	\$16.55
-27	2-7/8	2-5/16	---	---
-30	3	2-7/16	\$34.70	---

QUICK RELEASE PINS



These pins of stainless steel, are made to exacting standards. Pushing the button on top, it contracts and releases two (or four) balls at the end of the shank. These balls lock onto and release from the part for fast removal. The following types and sizes are most commonly used for hang gliders and not for structural aircraft. Request quote on special sizes (25 piece minimum). Less 10% for 12, Less 15% for 25, Less 20% for 50. May be assorted.

• Head Type - TEE • 1/4" Shank Diameter

Part No.	Alternate Part No.	MS Part No.	Length	Price
04-01486	LG4C-T-0.343	---	0.343"	\$43.50
04-01473	LG4C-T-1.40	MS17985-414	1.400"	\$45.50
04-01487	LG4C-T-2.10	MS17985-421	2.080"	\$38.65

CLEVIS BOLTS



AN23 - AN27 CLEVIS BOLTS

Clevis bolts have a slotted brazier type head. They are special-purpose bolts for use where a large shearing stress occurs (never in tension). Manufactured and cadmium plated in same manner as AN3 - AN8 aircraft bolts. Minimum tensile strength 125,000 PSI. Available with drilled or undrilled shank. Add letter "A" after dash number for undrilled shank. Prices fluctuate on clevis bolts.

HA

Dash No.	AN23 (3/16")				AN24 (1/4")				AN25 (5/16")				AN26 (3/8")				AN27 (7/16")			
	Grip	Length	Drilled	Un-Drilled	Grip	Length	Drilled	Un-Drilled	Grip	Length	Drilled	Un-Drilled	Grip	Length	Drilled	Un-Drilled	Grip	Length	Drilled	Un-Drilled
8	3/16	17/32	\$1.08	\$0.43	3/16	17/32	---	\$2.28	---	---	---	---	---	---	---	---	---	---	---	---
9	1/4	19/32	\$1.16	\$0.47	1/4	19/32	\$4.99	---	1/4	39/64	---	---	1/4	39/64	---	---	---	---	---	---
10	5/16	21/32	\$1.39	\$0.52	5/16	21/32	\$1.43	\$0.59	5/16	43/64	\$35.65	---	5/16	43/64	---	---	---	---	---	---
11	3/8	23/32	\$1.14	\$0.49	3/8	23/32	\$1.43	\$0.94	3/8	47/64	---	---	3/8	47/64	---	---	---	---	---	---
12	7/16	25/32	\$1.34	\$0.54	7/16	25/32	\$1.21	\$0.75	7/16	51/64	---	\$10.60	7/16	51/64	---	---	3/8	51/64	---	---
13	1/2	27/32	\$1.31	\$0.60	1/2	27/32	\$1.18	\$0.53	1/2	55/64	---	---	1/2	55/64	---	---	7/16	55/64	---	---
14	9/16	29/32	\$1.38	\$0.74	9/16	29/32	\$1.60	\$1.48	9/16	59/64	\$7.75	\$64.75	9/16	59/64	---	---	1/2	59/64	---	---
15	5/8	31/32	\$0.99	\$0.59	5/8	31/32	\$1.66	---	5/8	63/64	\$14.55	---	5/8	63/64	---	---	9/16	63/64	---	---
16	11/16	1-1/32	\$1.20	\$0.46	11/16	1-1/32	\$1.53	\$1.32	11/16	1-3/64	---	---	11/16	1-3/64	---	---	5/8	1-3/64	---	---
17	3/4	1-3/32	\$1.05	\$0.47	3/4	1-3/32	\$1.59	\$1.97	3/4	1-7/64	\$13.95	---	3/4	1-7/64	---	---	11/16	1-7/64	---	---
18	13/16	1-5/32	\$1.12	\$0.65	13/16	1-5/32	\$1.40	\$2.79	13/16	1-11/64	\$5.40	---	13/16	1-11/64	\$14.95	---	3/4	1-11/64	---	---
19	7/8	1-7/32	\$1.08	\$0.76	7/8	1-7/32	\$2.10	\$1.35	7/8	1-15/64	\$4.20	---	7/8	1-15/64	---	---	13/16	1-15/64	---	---
20	15/16	1-9/32	\$1.08	\$2.65	15/16	1-9/32	\$1.18	\$1.07	15/16	1-19/64	---	---	15/16	1-19/64	\$9.98	---	7/8	1-19/64	---	---
21	1	1-11/32	\$1.45	\$0.85	1	1-11/32	\$5.85	\$7.50	1	1-23/64	\$11.95	---	1	1-23/64	\$7.50	---	15/16	1-23/64	---	---
22	1-1/16	1-13/32	\$1.77	\$0.54	1-1/16	1-13/32	\$4.60	\$0.85	1-1/16	1-27/64	\$10.95	\$7.50	1-1/16	1-27/64	\$9.25	---	1	1-27/64	---	---
23	1-1/8	1-15/32	\$2.45	\$0.98	1-1/8	1-15/32	\$5.80	\$1.10	1-1/8	1-31/64	---	---	1-1/8	1-31/64	\$8.70	---	1-1/16	1-31/64	---	---
24	1-3/16	1-17/32	\$3.55	\$3.35	1-3/16	1-17/32	\$3.40	\$6.50	1-3/16	1-35/64	\$10.50	---	1-3/16	1-35/64	---	---	1-1/8	1-35/64	---	---
25	1-1/4	1-19/32	\$2.96	\$3.60	1-1/4	1-19/32	---	---	1-1/4	1-39/64	---	---	1-1/4	1-39/64	---	---	1-3/16	1-39/64	---	---
26	1-5/16	1-21/32	\$4.40	---	1-5/16	1-21/32	\$1.46	\$4.50	1-5/16	1-43/64	---	---	1-5/16	1-43/64	\$11.96	---	1-1/4	1-43/64	---	---
27	1-3/8	1-23/32	\$5.80	\$0.68	1-3/8	1-23/32	\$4.75	\$5.85	1-3/8	1-47/64	---	---	1-3/8	1-47/64	---	---	1-5/16	1-47/64	---	---
28	1-7/16	1-25/32	\$2.30	\$6.95	1-7/16	1-25/32	---	\$1.16	1-7/16	1-51/64	---	---	1-7/16	1-51/64	---	---	1-3/8	1-51/64	---	---
29	1-1/2	1-27/32	\$2.91	---	1-1/2	1-27/32	\$12.90	---	1-1/2	1-55/64	\$9.93	---	1-1/2	1-55/64	---	---	1-7/16	1-55/64	---	---
30	1-9/16	1-29/32	---	\$1.88	1-9/16	1-29/32	---	---	1-9/16	1-59/64	---	---	1-9/16	1-59/64	---	---	1-1/2	1-59/64	---	---
31	1-5/8	1-31/32	---	\$7.50	1-5/8	1-31/32	\$3.95	\$3.60	1-5/8	1-63/64	\$11.50	---	1-5/8	1-63/64	---	---	1-9/16	1-63/64	---	---
32	1-11/16	2-1/32	\$8.60	\$4.35	1-11/16	2-1/32	\$10.50	---	1-11/16	2-3/64	\$10.50	---	1-11/16	2-3/64	---	---	1-5/8	2-3/64	---	---
34	1-13/16	2-5/32	\$13.70	\$6.85	1-13/16	2-5/32	\$18.60	\$9.60	1-13/16	2-11/64	---	---	1-13/16	2-11/64	---	---	1-3/4	2-11/64	---	---
36	1-15/16	2-9/32	---	---	1-15/16	2-9/32	\$13.60	\$5.70	1-15/16	2-19/64	---	---	1-15/16	2-19/64	---	---	1-7/8	2-19/64	---	---
38	2-1/16	2-13/32	\$11.95	\$10.50	2-1/16	2-13/32	\$5.85	---	2-1/16	2-27/64	\$24.50	---	2-1/16	2-27/64	\$19.90	---	2	2-27/64	---	---
40	2-3/16	2-17/32	\$1.75	\$6.50	2-3/16	2-17/32	---	\$12.55	2-3/16	2-35/64	---	---	2-3/16	2-35/64	---	---	2-1/8	2-35/64	---	---

AN173, AN174, & AN175 CLOSE TOLERANCE BOLTS



Note: All AN173-AN175 bolts are drilled shank.

Non-corrosion-resistant cadmium-plated steel machine bolts. Manufactured to Revision 20 (April, 1990) of the military specification.

Cat. #	Dia. (inches)	Threads/inch	Length (inches)	Grip (inches)	Price		
AN173-5	.1900	32 NF-3A	.656	.250	\$0.84		
AN173-6			.781	.375	\$1.16		
AN173-7A			.906	.500	\$0.65		
AN173-7			.906	.500	\$0.89		
AN173-10			1.031	.625	\$0.95		
AN173-11			1.156	.750	\$1.44		
AN173-12			1.281	.875	\$1.83		
AN173-13			1.406	1.000	\$1.19		
AN173-14			1.531	1.125	\$0.87		
AN173-15			1.656	1.250	\$1.34		
AN173-16			1.781	1.375	\$1.84		
AN174-3			.2500	28 UNF-3A	.469	.062	-----
AN174-4					.531	.062	-----
AN174-5					.656	.188	\$1.72
AN174-6					.781	.312	\$1.15
AN174-7					.906	.438	\$1.87
AN174-10	1.031	.562			\$1.54		
AN174-11	1.156	.688			\$2.30		
AN174-12	1.281	.812			\$2.05		
AN174-13	1.406	.938			\$1.49		
AN174-14	1.531	1.062			\$3.00		
AN174-15	1.656	1.188			\$1.49		

Cat. #	Dia. (inches)	Threads/inch	Length (inches)	Grip (inches)	Price		
AN174-16	.2500	28 UNF-3A	1.781	1.312	-----		
AN174-17			1.906	1.438	\$1.08		
AN174-20			2.031	1.562	\$1.04		
AN174-21			2.156	1.688	-----		
AN174-23			2.406	1.938	\$9.94		
AN174-24			2.531	2.062	-----		
AN175-14			.3125	24 UNF-3A	1.594	1.062	-----
AN175-15					1.719	1.188	\$4.75
AN175-16					1.844	1.312	\$1.85
AN175-17					1.969	1.438	-----
AN175-20					2.094	1.562	\$5.40
AN175-21					2.219	1.688	\$10.50
AN175-22					2.344	1.812	\$6.50
AN175-23					2.469	1.938	-----
AN175-24					2.594	2.062	-----
AN175-25					2.719	2.188	-----
AN175-26	2.844	2.312			-----		
AN175-27	2.969	2.438			-----		
AN175-30	3.094	2.562			-----		
AN175-31	3.219	2.688			-----		
AN175-32	3.344	2.812			\$2.37		
AN175-33	3.469	2.938			\$2.95		

Cat. #	Nominal Length	Grip Length	Price
AN176-10A	1-3/32	7/16	\$8.95
AN176-13A	1-15/32	13/16	\$2.44
AN176-14A	1-19/32	15/16	\$3.25
AN176-15	1-1/16	1-45/64	-----

NAS SHEAR BOLTS



These bolts supersede NAS1103–NAS1106 high strength bolts. Made from alloy steel with a CAD II finish.

Part numbers with “D” are for shank drilled. All others are undrilled bolts.

Part Number	Thread	Grip Length	Length	Price
NAS6203-10	10-32	0.625	0.948	\$0.25
NAS6203-10D	10-32	0.625	0.948	\$1.83
NAS6203-11	10-32	0.688	1.011	\$0.58
NAS6203-11D	10-32	0.688	1.011	\$1.52
NAS6203-12	10-32	0.750	1.073	\$0.36
NAS6203-12D	10-32	0.750	1.073	\$1.09
NAS6203-13	10-32	0.813	1.136	\$0.68
NAS6203-13D	10-32	0.813	1.136	\$1.06
NAS6203-14	10-32	0.875	1.198	\$0.48
NAS6203-14D	10-32	0.875	1.198	\$1.21
NAS6203-15	10-32	0.938	1.261	\$0.46
NAS6203-15D	10-32	0.938	1.261	\$1.08
NAS6203-16	10-32	1.000	1.323	\$0.72
NAS6203-16D	10-32	1.000	1.323	\$1.12
NAS6203-17	10-32	1.063	1.386	\$0.59
NAS6203-17D	10-32	1.063	1.386	\$1.59
NAS6203-18	10-32	1.125	1.448	\$0.62
NAS6203-18D	10-32	1.125	1.448	\$1.50
NAS6203-19	10-32	1.188	1.511	\$0.62
NAS6203-19D	10-32	1.188	1.511	\$1.62
NAS6203-2	10-32	0.125	0.448	\$0.30
NAS6203-20	10-32	1.250	1.573	\$0.98
NAS6203-20D	10-32	1.250	1.573	\$1.06
NAS6203-21	10-32	1.313	1.636	\$0.65
NAS6203-21D	10-32	1.313	1.636	\$1.67
NAS6203-22	10-32	1.375	1.698	\$0.66
NAS6203-22D	10-32	1.375	1.698	\$1.63
NAS6203-23	10-32	1.438	1.761	\$0.68
NAS6203-23D	10-32	1.438	1.761	\$2.29
NAS6203-24	10-32	1.500	1.823	\$0.76
NAS6203-24D	10-32	1.500	1.823	\$1.70
NAS6203-3	10-32	0.188	0.511	\$0.30
NAS6203-32	10-32	2.000	2.323	\$3.35
NAS6203-38	10-32	2.375	2.698	\$9.50
NAS6203-3D	10-32	0.188	0.511	\$0.72
NAS6203-4	10-32	0.250	0.573	\$0.27
NAS6203-4D	10-32	0.250	0.573	\$1.52
NAS6203-5	10-32	0.313	0.636	\$0.26
NAS6203-56	10-32	3.500	3.823	\$6.50
NAS6203-5D	10-32	0.313	0.636	\$1.30
NAS6203-6	10-32	0.375	0.698	\$0.39
NAS6203-6D	10-32	0.375	0.698	\$0.85
NAS6203-7	10-32	0.438	0.761	\$0.28
NAS6203-7D	10-32	0.438	0.761	\$0.97
NAS6203-8	10-32	0.500	0.823	\$0.31
NAS6203-8D	10-32	0.500	0.823	\$0.98
NAS6203-9	10-32	0.563	0.886	\$0.53
NAS6203-9D	10-32	0.563	0.886	\$1.70
NAS6204-10	1/4-28	0.625	0.995	\$0.42

Part Number	Thread	Grip Length	Length	Price
NAS6204-10D	1/4-28	0.625	0.995	\$1.26
NAS6204-11	1/4-28	0.688	1.058	\$0.49
NAS6204-11D	1/4-28	0.688	1.058	\$0.99
NAS6204-12	1/4-28	0.750	1.120	\$0.72
NAS6204-12D	1/4-28	0.750	1.120	\$2.33
NAS6204-13	1/4-28	0.813	1.183	\$0.72
NAS6204-13D	1/4-28	0.813	1.183	\$1.92
NAS6204-14	1/4-28	0.875	1.245	\$0.80
NAS6204-14D	1/4-28	0.875	1.245	\$1.59
NAS6204-15	1/4-28	0.938	1.308	\$0.76
NAS6204-15D	1/4-28	0.938	1.308	\$2.23
NAS6204-16	1/4-28	1.000	1.370	\$0.58
NAS6204-16D	1/4-28	1.000	1.370	\$2.03
NAS6204-17	1/4-28	1.063	1.433	\$0.97
NAS6204-17D	1/4-28	1.063	1.433	\$1.73
NAS6204-18	1/4-28	1.125	1.495	\$0.89
NAS6204-18D	1/4-28	1.125	1.495	\$1.80
NAS6204-19	1/4-28	1.188	1.558	\$0.93
NAS6204-19D	1/4-28	1.188	1.558	\$1.96
NAS6204-2	1/4-28	0.125	0.495	\$0.46
NAS6204-20	1/4-28	1.250	1.620	\$0.94
NAS6204-20D	1/4-28	1.250	1.620	\$1.91
NAS6204-21	1/4-28	1.313	1.683	\$2.25
NAS6204-21D	1/4-28	1.313	1.683	\$1.97
NAS6204-22	1/4-28	1.375	1.745	\$1.12
NAS6204-22D	1/4-28	1.375	1.745	\$2.68
NAS6204-23	1/4-28	1.438	1.808	\$1.26
NAS6204-23D	1/4-28	1.438	1.808	\$2.20
NAS6204-24	1/4-28	1.500	1.870	\$1.19
NAS6204-24D	1/4-28	1.500	1.870	\$2.30
NAS6204-25	1/4-28	1.562	1.932	\$2.40
NAS6204-28	1/4-28	1.750	2.120	\$1.44
NAS6204-3	1/4-28	0.188	0.558	\$0.45
NAS6204-4	1/4-28	0.250	0.620	\$0.48
NAS6204-4D	1/4-28	0.250	0.620	\$0.97
NAS6204-5	1/4-28	0.313	0.683	\$0.35
NAS6204-5D	1/4-28	0.313	0.683	\$1.55
NAS6204-6	1/4-28	0.375	0.745	\$0.48
NAS6204-6D	1/4-28	0.375	0.745	\$1.53
NAS6204-7	1/4-28	0.438	0.808	\$0.58
NAS6204-7D	1/4-28	0.438	0.808	\$1.30
NAS6204-8	1/4-28	0.500	0.870	\$0.56
NAS6204-8D	1/4-28	0.500	0.870	\$0.98
NAS6204-9	1/4-28	0.563	0.933	\$0.70
NAS6204-9D	1/4-28	0.563	0.933	\$0.90
NAS6604D15	1/4-28	0.938	1.363	\$2.00
691-349	1/4-28	0.938	1.363	\$6.90
NAS6205-11	5/16-24	0.688	1.126	\$2.45
NAS6205-11D	5/16-24	0.688	1.126	\$3.90
NAS6205-12	5/16-24	0.750	1.188	\$1.31
NAS6205-13D	5/16-24	0.812	1.250	\$4.75
NAS6205-15	5/16-24	0.938	1.376	\$2.75
NAS6205-19	5/16-24	1.188	1.626	\$4.35
NAS6205-20	5/16-24	1.250	1.688	\$4.80

HA

NAS SHEAR BOLTS

HA

Part Number	Thread	Grip Length	Length	Price
NAS6205-20D	5/16-24	1.250	1.688	\$3.85
NAS6205-22	5/16-24	1.375	1.813	\$5.35
NAS6205-24D	5/16-24	1.500	1.938	\$8.45
NAS6205-4	5/16-24	0.250	0.688	\$1.92
NAS6205-5	5/16-24	0.312	0.750	\$1.10
NAS6205-6	5/16-24	0.375	0.813	\$1.60
NAS6205-6D	5/16-24	0.375	0.813	\$9.95
NAS6205-8	5/16-24	0.500	0.938	\$5.70
NAS6205-9	5/16-24	0.562	1.000	\$2.30
NAS6206-13	3/8-24	0.812	1.266	\$7.50
NAS6206-14D	3/8-24	0.875	1.329	\$7.50
NAS6206-17	3/8-24	1.062	1.516	\$5.70
NAS6206-21	3/8-24	1.312	1.766	\$14.50
NAS6206-22	3/8-24	1.375	1.829	\$4.35
NAS6206-23	3/8-24	1.438	1.892	\$9.50
NAS6206-23D	3/8-24	1.438	1.892	\$29.50
NAS6206-32	3/8-24	0.002	2.454	\$13.50
NAS6206-9	3/8-24	0.562	1.016	\$4.50
NAS6206H-4	3/8-24	0.250	0.704	\$0.00
NAS6603-1	10-32	0.063	0.408	\$0.23
NAS6603-10	10-32	0.625	0.970	\$0.33
NAS6603-11	10-32	0.688	1.033	\$0.31
NAS6603-12	10-32	0.750	1.095	\$0.36
NAS6603-13	10-32	0.813	1.158	\$0.41
NAS6603-14	10-32	0.875	1.220	\$0.38
NAS6603-15	10-32	0.938	1.283	\$0.76
NAS6603-16	10-32	1.000	1.345	\$0.56
NAS6603-17	10-32	1.063	1.408	\$0.60
NAS6603-18	10-32	1.125	1.470	\$0.66
NAS6603-19	10-32	1.188	1.533	\$0.66
NAS6603-2	10-32	0.063	0.408	\$0.32
NAS6603-20	10-32	1.250	1.595	\$0.69
NAS6603-21	10-32	1.313	1.658	\$0.70
NAS6603-22	10-32	1.375	1.720	\$0.70
NAS6603-23	10-32	1.438	1.783	\$0.72
NAS6603-24	10-32	1.500	1.845	\$0.73
NAS6603-3	10-32	0.188	0.533	\$0.38
NAS6603-4	10-32	0.250	0.595	\$0.28
NAS6603-5	10-32	0.313	0.658	\$0.35
NAS6603-6	10-32	0.375	0.720	\$0.29
NAS6603-8	10-32	0.500	0.845	\$0.29
NAS6603-9	10-32	0.563	0.908	\$0.29
NAS6604-10	1/4-28	0.625	1.050	\$0.61
NAS6604-11	1/4-28	0.688	1.113	\$0.54
NAS6604-12	1/4-28	0.750	1.175	\$0.60
NAS6604-13	1/4-28	0.813	1.238	\$0.55
NAS6604-14	1/4-28	0.875	1.300	\$0.67
NAS6604-15	1/4-28	0.938	1.363	\$0.68
NAS6604-16	1/4-28	1.000	1.425	\$0.76
NAS6604-17	1/4-28	1.063	1.488	\$1.13
NAS6604-18	1/4-28	1.125	1.550	\$1.40
NAS6604-19	1/4-28	1.188	1.613	\$1.27
NAS6604-20	1/4-28	1.250	1.675	\$1.26
NAS6604-21	1/4-28	1.313	1.738	\$1.14

Part Number	Thread	Grip Length	Length	Price
NAS6604-22	1/4-28	1.375	1.800	\$1.17
NAS6604-23	1/4-28	1.438	1.863	\$1.19
NAS6604-24	1/4-28	1.500	1.925	\$1.19
NAS6604-3	1/4-28	0.188	0.613	\$0.45
NAS6604-4	1/4-28	0.250	0.675	\$0.39
NAS6604-5	1/4-28	0.313	0.738	\$0.45
NAS6604-56D	1/4-28	3.625	3.870	\$9.75
NAS6604-7	1/4-28	0.438	0.863	\$0.55
NAS6604-8	1/4-28	0.500	0.925	\$0.56
NAS6604-9	1/4-28	0.563	0.988	\$0.51
NAS6605-10	5/16-24	0.625	1.094	\$0.94
NAS6605-11	5/16-24	0.688	1.157	\$0.93
NAS6605-12	5/16-24	0.750	1.219	\$0.98
NAS6605-13	5/16-24	0.813	1.282	\$0.99
NAS6605-14	5/16-24	0.875	1.344	\$1.93
NAS6605-15	5/16-24	0.938	1.407	\$1.08
NAS6605-16	5/16-24	1.000	1.469	\$1.13
NAS6605-17	5/16-24	1.063	1.532	\$1.68
NAS6605-18	5/16-24	1.125	1.594	\$1.27
NAS6605-20	5/16-24	1.250	1.719	\$1.24
NAS6605-21	5/16-24	1.313	1.782	\$1.25
NAS6605-22	5/16-24	1.375	1.844	\$1.27
NAS6605-23	5/16-24	1.438	1.907	\$1.22
NAS6605-24	5/16-24	1.500	1.969	\$1.33
NAS6605-3	5/16-24	0.188	0.657	\$1.47
NAS6605-4	5/16-24	0.250	0.719	\$0.78
NAS6605-5	5/16-24	0.313	0.782	\$0.75
NAS6605-6	5/16-24	0.375	0.844	\$0.79
NAS6605-7	5/16-24	0.438	0.907	\$0.80
NAS6605-8	5/16-24	0.500	0.969	\$1.03
NAS6605-9	5/16-24	0.563	1.032	\$0.88
NAS6606-10	3/8-24	0.625	1.203	\$1.78
NAS6606-11	3/8-24	0.688	1.266	\$2.12
NAS6606-12	3/8-24	0.750	1.328	\$4.35
NAS6606-13	3/8-24	0.813	1.391	\$2.20
NAS6606-14	3/8-24	0.875	1.453	\$2.20
NAS6606-15	3/8-24	0.938	1.516	\$3.35
NAS6606-16	3/8-24	1.000	1.578	\$2.15
NAS6606-17	3/8-24	1.063	1.641	\$2.30
NAS6606-18	3/8-24	1.125	1.703	\$2.35
NAS6606-19	3/8-24	1.188	1.766	\$2.35
NAS6606-20	3/8-24	1.250	1.828	\$2.86
NAS6606-21	3/8-24	1.313	1.891	\$2.40
NAS6606-22	3/8-24	1.375	1.953	\$3.35
NAS6606-23	3/8-24	1.438	2.016	\$5.35
NAS6606-24	3/8-24	1.500	2.078	\$3.50
NAS6606-3	3/8-24	0.188	0.766	\$1.55
NAS6606-4	3/8-24	0.250	0.828	\$2.15
NAS6606-5	3/8-24	0.313	0.891	\$2.49
NAS6606-6	3/8-24	0.375	0.953	\$1.57
NAS6606-7	3/8-24	0.438	1.016	\$2.82
NAS6606-8	3/8-24	0.500	1.078	\$1.90
NAS6606-9	3/8-24	0.563	1.141	\$3.80

ENGINE BOLTS / HARDWARE KITS



MS20073 / MS20074 ENGINE BOLTS

Part No.	Old AN	Thread	Grip	Length	Price
MS20073-03-04	AN73-4	1032 Fine Thread	0.0620	0.5940	\$2.07
MS20073-03-05	AN73-5	1032 Fine Thread	0.1250	0.6560	\$2.22
MS20073-03-06	AN73-6	1032 Fine Thread	0.2500	0.7810	\$2.22
MS20073-04-03	AN74-3	1/4-28 Fine Thread	0.0620	0.4690	\$2.39
MS20073-04-04	AN74-4	1/4-28 Fine Thread	0.0620	0.5940	\$1.95
MS20073-04-06	AN74-6	1/4-28 Fine Thread	0.2500	0.7810	\$2.30
MS20073-04-07	AN74-7	1/4-28 Fine Thread	0.3750	0.9060	\$2.09
MS20074-03-03	AN73A3	1024 Coarse Thread	0.0620	0.4690	\$2.61
MS20074-03-04	AN73A4	1024 Coarse Thread	0.0620	0.5940	\$2.14

METRIC PROP BOLTS



Description	Part No.	Price
Prop Bolt 8x70mm Drilled Head For Safety Wire	15-04929	\$6.50
Prop Bolt 8x80mm Drilled Head For Safety Wire	15-04930	\$7.95
Prop Bolt 8x90mm Drilled Head For Safety Wire	15-04931	\$8.90

BEGINNER'S BOLT KITS

UNDRILLED KIT 102 PIECES

AN3	QTY	AN4	QTY	AN5	QTY
-3A	4	-5A	6	-4A	6
-4A	6	-6A	6	-6A	6
-5A	6	-7A	6	-10A	6
-6A	6	-10A	6	-11A	6
-7A	6	-11A	6	-13A	4
-10A	6	-15A	4	-14A	6

P/N 04-00090 \$57.75

DRILLED KIT 102 PIECES

AN3	QTY	AN4	QTY	AN5	QTY
-4	6	-6	6	-6	6
-5	6	-7	6	-10	6
-6	6	-10	6	-14	6
-7	6	-12	6	-15	4
-10	6	-13	6	-16	6
-11	4	-14	4	-17	6

P/N 04-00100 \$126.99

HOMEBUILDER'S KIT

CADMIUM PLATED 629 PIECES / AN BOLTS CONTAINS 4 EACH

DRILLED			UNDRILLED		
AN3-4	AN3-14	AN4-11	AN3-4A	AN3-14A	AN4-11A
AN3-5	AN3-15	AN4-12	AN3-5A	AN3-15A	AN4-12A
AN3-6	AN3-16	AN4-13	AN3-6A	AN3-16A	AN4-13A
AN3-7	AN3-17	AN4-14	AN3-7A	AN3-17A	AN4-14A
AN3-10	AN3-20	AN4-15	AN3-10A	AN3-20A	AN4-15A
AN3-11	AN4-6	AN4-16	AN3-11A	AN4-6A	AN4-16A
AN3-12	AN4-7	AN4-17	AN3-12A	AN4-7A	AN4-17A
AN3-13	AN4-10	AN4-20	AN3-13A	AN4-10A	AN4-20A

Also Included:

NYLON INSERT LOCKNUTS

ITEM #	QTY
AN365-1032	52
AN365-428	44

FLAT WASHERS

AN960-10	30
AN960-10L	30
AN960-416	30
AN960-416L	30

CASTLE NUTS

ITEM #	QTY
AN310-3	52
AN310-4	44

COTTER PINS

ITEM #	QTY
AN380-2-2	125

P/N 04-00230 \$265.95

Part No.	Old AN	Thread	Grip	Length	Price
MS20074-04-03	AN74A3	1/4-20 Coarse Thread	0.0620	0.4690	\$2.31
MS20074-04-04	AN74A4	1/4-20 Coarse Thread	0.0620	0.5940	\$2.09
MS20074-04-05	AN74A5	1/4-20 Coarse Thread	0.1250	0.6560	\$2.40
MS20074-04-06	AN74A6	1/4-20 Coarse Thread	0.2500	0.7810	\$2.45
MS20074-04-07	AN74A7	1/4-20 Coarse Thread	0.3750	0.9060	\$2.30
MS20074-04-12	AN75A12	1/4-20 Coarse Thread	.7500	1.2810	\$7.50
MS20074-04-21	AN74A21	1/4-20 Coarse Thread	1.6250	2.1560	\$8.50
MS20074-06-06	AN76A6	3/8-16 Coarse Thread	.1250	.7970	\$6.65

BOLT 8MM X 20 COARSE



Hex head screw 8mm x 20, steel. Zinc plated P/N 15-05052 \$0.55

ADVANCED MECHANIC'S KIT

CADMIUM PLATED

DRILLED	UNDRILLED	AN3	AN4	AN5	AN6
-4	-4A	3	3	3	3
-5	-5A	3	3	3	3
-6	-6A	3	3	3	3
-7	-7A	3	3	3	3
-10	-10A	3	3	3	3
-11	-11A	3	3	3	3
-12	-12A	3	3	3	3
-13	-13A	3	3	3	3
-15	-15A	3	3	3	3

Also Includes:

FLAT WASHERS

ITEM #	QTY
AN960-10	100
AN960-416	100
AN960-516	100
AN960-616	100

NYLON INSERT LOCKNUTS

ITEM#	QTY
AN365-1032	27
AN365-428	27
AN365-524	27
AN365-624	27

COTTER PINS

ITEM #	QTY.
AN380-2-3	100
AN380-25-3	200
AN380-3-3	100

CASTLE NUTS

ITEM#	QTY
AN310-3	27
AN310-4	27
AN310-5	27
AN310-6	27

P/N 04-00240 \$393.95

DELUXE BOLT PACK

UNDRILLED KIT BOLTS 500 PIECES

AN3	QTY	AN4	QTY	AN5	QTY
-3A	10	-5A	10	-6A	10
-4A	10	-6A	10	-10A	10
-5A	10	-7A	10	-12A	10
-6A	10	-10A	10	-16A	10
-7A	10	-11A	10		
-10A	10	-12A	10		
-11A	10	-13A	10		
-12A	10	-14A	10		
-13A	10	-15A	10		
-14A	10	-16A	10		
-15A	10	-17A	10		
-16A	10	-22A	10		
-17A	10	-24A	10		
-20A	10	-26A	10		

DRILLED KIT BOLTS

AN3	QTY	AN4	QTY	AN5	QTY
-5	10	-6	10	-7	10
-6	10	-7	10	-14	10
-7	10	-10	10	-17	10
-10	10	-12	10	-24	10
-12	10	-16	10		
-15	10	-20	10		
-20	10				
-24	10				

P/N 04-00245 \$277.95

HARDWARE KITS

ECONOMY AN BOLT ASSORTMENTS

BOLT ASSORTMENT - UNDRILLED



Qty	Part No.	Qty	Part No.	Qty	Part No.
10	AN3-3A	4	AN4-4A	4	AN5-5A
10	AN3-4A	4	AN4-5A	4	AN5-6A
10	AN3-5A	4	AN4-6A	4	AN5-7A
10	AN3-6A	4	AN4-7A	4	AN5-10A
10	AN3-7A	4	AN4-10A	4	AN5-11A
10	AN3-10A	4	AN4-11A	4	AN5-12A
4	AN3-11A	4	AN4-12A	4	AN5-13A
4	AN3-12A	4	AN4-13A	4	AN5-14A
4	AN3-13A	4	AN4-14A	4	AN5-15A
4	AN3-14A	4	AN4-15A	4	AN5-16A
4	AN3-15A	4	AN4-16A	4	AN5-17A
4	AN3-16A	4	AN4-17A	4	AN5-20A
4	AN3-17A	4	AN4-20A	4	AN5-24A
4	AN3-20A	4	AN4-24A		
4	AN3-24A				

204-piece Undrilled Assortment..... P/N 04-00105.....**\$75.50**
 Above with 44-Drawer Cabinet P/N 04-00110.....**\$174.95**

BOLT ASSORTMENT - DRILLED



Qty	Part No.	Qty	Part No.	Qty	Part No.
10	AN3-3	4	AN4-4	4	AN5-5
10	AN3-4	4	AN4-5	4	AN5-6
10	AN3-5	4	AN4-6	4	AN5-7
10	AN3-6	4	AN4-7	4	AN5-10
10	AN3-7	4	AN4-10	4	AN5-11
10	AN3-10	4	AN4-11	4	AN5-12
4	AN3-11	4	AN4-12	4	AN5-13
4	AN3-12	4	AN4-13	4	AN5-14
4	AN3-13	4	AN4-14	4	AN5-15
4	AN3-14	4	AN4-15	4	AN5-16
4	AN3-15	4	AN4-16	4	AN5-17
4	AN3-16	4	AN4-17	4	AN5-20
4	AN3-17	4	AN4-20	4	AN5-24
4	AN3-20	4	AN4-24	4	
1	AN3-24	4		4	

204-piece Drilled Assortment..... P/N 04-00115.....**\$173.95**
 Above with 44-Drawer Cabinet P/N 04-00120.....**\$273.95**

HA



ECONOMY COMBINED AN BOLT ASSORTMENT

Both drilled and undrilled assortments shown above
 P/N 04-00125.....**\$249.95**

Both assortments shown above with 16-Drawer & 64-Drawer storage cabinets... P/N 04-00130.....**\$398.95**



ECONOMY WASHER & COTTER PIN ASSORTMENTS

To Accompany AN Bolt Assortments Shown Above

Washers For Undrilled Assortment
 P/N 04-00135..... **\$15.00**

Washers & Cotter Pins For Drilled Bolt Assortment
 P/N 04-00140..... **\$41.00**

Washers & Cotter Pins For Combined Assortment
 P/N 04-00145..... **\$67.60**



WASHER ASSORTMENTS 1,500 PIECES - STAINLESS

Contains 100 each of the following:
 • 6, 8 & 10 AN960C & AN960CL
 • 6, 8 & 10 Nylon
 • 6, 8 & 10 MS35333
 • 6, 8 & 10 MS35338..... P/N 04-00220.....**\$64.00**



WASHER ASSORTMENTS 1,500 PIECES - CAD-PLATED

Contains 100 each of the following:
 6, 8 & 10 AN960 & AN960L
 6, 8 & 10 Nylon Washer
 6, 8 & 10 MS35333
 6, 8 & 10 MS35338..... P/N 04-00215.....**\$37.25**



OILITE BRONZE FLANGED BUSHINGS

Oilite bronze bushings are highly heat resistant, ductile, conformable and corrosion resistant.

Model No.	Part No.	Hole I.D.	Hole O.D.	Length	Flange O.D.	Flange Thickness	Price Each
FB46-02	04-01646	1/4	3/8	1/4	1/2	3/64	\$0.45
FB810-04	04-01647	1/2	5/8	1/2	7/8	1/8	\$0.98
FB810-08	04-01648	1/2	5/8	1	7/8	1/8	\$1.40
FB812-08	04-01649	1/2	3/4	1	1	1/8	\$1.75
FB1012-04	04-01639	5/8	3/4	1/2	1	1/8	\$0.95
FB1012-08	04-01640	5/8	3/4	1	1	1/8	\$1.75
FB-1013-08	04-01641	.6270	.8150	1	1-1/16	5/32	\$2.55
FB1214-06	04-01642	3/4	7/8	3/4	1-1/8	5/32	\$1.50
FB-1620-06	04-01644	1	1-1/4	3/4	1-1/2	3/16	\$3.35
FB1620-10	04-01645	1	1-1/4	1-1/4	1-1/2	3/16	\$6.50
FF303-01	04-01650	3/16	5/16	3/16	7/16	1/16	\$0.45
FF312-02	04-01651	.252	.3775	1/2	15/32	1/16	\$0.65
FF435-1	04-01652	1/4	7/16	1/2	1/2	1/16	\$1.45
FF512-03	04-01653	.3765	.5030	5/8	5/8	3/32	\$0.62
FF520-10	05-02114	3/8	1/2	3/8	5/8	1/16	\$1.55
FF520-15	FF520-15	3/8	1/2	1/4	5/8	1/16	\$0.60
FF620-01	04-01654	.5020	.6270	1/2	7/8	1/16	\$0.95
FF730-03	04-01655	5/8	3/4	5/8	1	3/32	\$1.35



OILITE BRONZE STRAIGHT BUSHINGS

Oilite Impregnated Bronze. SAE 841.

Model No.	Part No.	Hole I.D.	Hole O.D.	Length	Price Ea.
AA304-20	05-01856	1/4	3/8	1	\$0.90
AA309-5	05-01857	3/16	5/16	3/4	\$0.85
B812-6	05-02098	1/2	3/4	3/4	\$1.55
B812-7	05-02099	1/2	3/4	7/8	\$2.15
B610-6	04-01944	3/8	5/8	3/4	\$1.45
8363	05-04543	5/8	1	1-1/8	\$4.35

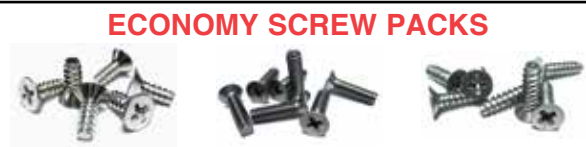

ECONOMY SCREW PACKS

1/2" 100° 600-Piece Screw Pack
 Flat Phillips - AN507C Machine Screws
 Flat Phillips Sheet Metal Screws

100..... 6-32 x 1/2 | 100..... 6 x 1/2B
 100..... 8-32 x 1/2 | 100..... 8 x 1/2B
 100..... 10-32 x 1/2 | 100..... 10 x 1/2B

Stainless P/N 04-00185..... **\$62.00**
 Steel Plated..... P/N 04-00180..... **\$58.75**

1/2" 600-Piece Screw Pack
 Truss Phillips - AN526C Machine Screws
 Truss Phillips Sheet Metal Screws

100..... 6-32 x 1/2 | 100..... 6 x 1/2A
 100..... 8-32 x 1/2 | 100..... 8 x 1/2A
 100..... 10-32 x 1/2 | 100..... 10 x 1/2A

Stainless P/N 04-00195..... **\$46.00**
 Steel Plated..... P/N 04-00190..... **\$48.00**

1/2" 900-Piece Screw Pack
 The entire contents of 600-piece pack shown above plus the following:
 AN507C 100° CSK
 Flat Phillips Machine Screws

100..... 6-32 x 1/2 | 100..... 8-32 x 1/2 | 100..... 10-32 x 1/2

Stainless..... P/N 04-00210..... **\$76.00**
 Steel plated..... P/N 04-00205..... **\$58.75**

HARDWARE KITS

ECONOMY SCREW KIT STAINLESS STEEL - 2,100 PIECES

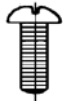

**AN526C Machine
Truss Phillips**



**AN507C Machine
100° CSK, Flat Phillips**

Sizes 6-32, 8-32, 10-32

100.....	1/2"	100.....	1/2"
50.....	5/8"	50.....	5/8"
25.....	3/4"	25.....	3/4"
25.....	1"	25.....	1"



**Sheet Metal
Truss Phillips**



**Sheet Metal
100° CSK, Flat Phillips**

Sizes 6, 8, 10

100.....	1/2"	100.....	1/2"
50.....	5/8"		
25.....	3/4"		
25.....	1"		

Stainless Kit P/N 04-00290 **\$213.95**

SCREW KITS LARGE ASSORTMENT 2,250 PIECES



**AN526 Machine
Screw, Truss Phillips**



**Sheet Metal
Screw, Truss Phillips**

100.....	4-40 x 1/2	100.....	4 x 1/2
100.....	6-32 x 1/2	100.....	6 x 1/2
100.....	8-40 x 3/8	100.....	8 x 1/2
100.....	8-32 x 1/2	100.....	8 x 1/2B
100.....	10-32 x 1/2	100.....	10 x 1/2
100.....	10-32 x 3/4		

**AN507 100° CSK
Machine Screw, FP**

100.....	6-32 x 1/2	50.....	6-32
100.....	8-32 x 1/2	50.....	8-32
100.....	10-32 x 1/2	50.....	10-32

**Nylon Insert
Locknuts**

50.....	6-32		
50.....	8-32		
50.....	10-32		

**Flat Washer
AN960**

100.....	6
100.....	8
100.....	10

**Nylon
Washers**

100.....	6
100.....	8
100.....	10

**100° CSK
Washers**

50.....	8
50.....	10

Stainless Kit P/N 04-00295 **\$174.95**
Steel Plated Kit..... P/N 04-00296 **\$169.95**

NUT-COTTER PIN ASSORTMENTS

CAD-PLATED COTTER PIN KIT



400 PCS

100.....	1/16 x 1/2"	50.....	1/8 x 1"
100.....	5/64 x 1/2"	25.....	5/32 x 2"
100.....	3/32 x 1/2"	25.....	3/16 x 2"

P/N 04-00155 **\$35.00**

500 PCS

100.....	1/16 x 1/2"	50.....	1/16 x 1-1/2"
100.....	5/64 x 3/4"	50.....	5A/32 x 2"
100.....	3/32 x 1"	25.....	A3/16 x 2"
50.....	1/8 x 3/4"	25.....	3/16 x 2-1/2"

P/N 04-00165 **\$84.75**

STAINLESS STEEL COTTER PIN KIT



400 PCS

100.....	1/16 x 1/2"	50.....	1/8 x 1"
100.....	5/64 x 1/2"	25.....	5/32 x 2"
100.....	3/32 x 1/2"	25.....	3/16 x 2"

P/N 04-00150 **\$85.00**

500 PCS

100.....	1/16 x 1/2"	50.....	1/16 x 1-1/2"
100.....	5/64 x 3/4"	50.....	5A/32 x 2"
100.....	3/32 x 1"	25.....	A3/16 x 2"
50.....	1/8 x 3/4"	25.....	3/16 x 2-1/2"

P/N 04-00160 **\$128.00**

DELUXE COTTER PIN KITS 850 PCS

AN380 - Cad-Plated

Dash	Size	Qty.	Dash	Size	Qty.
-1-2	1/32 x 1/2"	50	-3-4	3/32 x 1"	75
-1-4	1/32 x 1"	50	-3-6	3/32 x 1-1/2"	25
-2-2	1/16 x 1/2"	100	-3-8	3/32 x 2"	25
-2-3	1/16 x 3/4"	100	-4-3	1/8 x 3/4"	25
-2-4	1/16 x 1"	100	-4-5	1/8 x 1-1/4"	75
-25-2	5/64 x 1/2"	25	-4-8	1/8 x 2"	50
-25-3	5/64 x 3/4"	25	-4-10	1/8 x 2-1/2"	50
-3-3	3/32 x 3/4"	75			

P/N 04-00375 **\$115.95**

AN381 - Stainless

Dash	Size	Qty.	Dash	Size	Qty.
-1-8	1/16 x 1/2"	100	-3-16	3/32 x 1"	75
-2-12	1/16 x 3/4"	100	-3-24	3/32 x 1-1/2"	25
-2-16	1/16 x 1"	100	-4-12	1/8 x 3/4"	25
-2-24	1/16 x 1-1/2"	50	-4-16	1/8 x 1"	50
-25-8	5/64 x 3/4"	50	-4-24	1/8 x 1-1/2"	25
-25-12	5/64 x 1/2"	75	-4-32	1/8 x 2"	25
-3-8	3/32 x 1/2"	75	-4-40	1/8 x 2-1/2"	25
-3-12	3/32 x 3/4"	50			

P/N 04-00380 **\$189.95**



ECONOMY NUT PACKS

**AN365C NUT KIT
STAINLESS**

Qty.	P/N	Qty.	P/N
25	4-40	50	6-32
50	8-32	50	0-32
25	1/4-28		

Stainless Kit P/N 04-00170 **\$99.95**
Cad Plated Kit..... P/N 04-00175 **\$88.00**

**AN365 NUT KIT
CAD-PLATED**

Qty.	P/N	Qty.	P/N
50	4-40	100	6-32
100	8-32	100	10-32
50	1/4-28		

LOCKNUT KIT

CAD-PLATED. FOR UNDRILLED BOLT ASSORTMENT.

100 ea ... AN365-1032 56 ea AN365-428 52 ea ... AN365-524
P/N 04-00330 **\$37.00**

AN365C NUT KIT STAINLESS 200 PIECES

50 ea ... 632 50 ea ... 832 50 ea ... 1032 25 ea ... 428 25 ea ... 524
P/N 04-00340 **\$128.95**

AN365 NUT KIT CAD-PLATED - 400 PIECES

100 ea .. 632 100 ea .. 832 100 ea .. 1032 50 ea ... 428 50 ea ... 524
P/N 04-00345 **\$81.00**



CASTLE NUT KIT 208 PIECES CAD-PLATED. FOR DRILLED BOLT ASSORTMENT.

100 ea ... AN310-3 56 ea ... AN310-4 52 ea ... AN310-5
P/N 04-00335 **\$212.95**

470 PIECE COMBO NUT ASSORTMENT

Nylon Insert Locknuts

Item #	Qty.
AN365-632	15
AN365-832	50
AN365-1032	50
AN365-428	50
AN365-524	15

Plain Hex Nuts

Item #	Qty.
AN315-3	25
AN315-4	25
AN315-5	15
AN315-6	15

Castle Nuts

Item #	Qty.
AN310-3	50
AN310-4	50
AN310-5	15
AN310-6	15

Shear Castle Nuts

Item #	Qty.
AN320-3	25
AN320-4	25
AN320-5	15
AN320-6	15

P/N 04-00350 **\$315.95**

HARDWARE KITS

DELUXE BOLT PACK

700 BOLTS - 50 Sizes, individually packaged. AN3, AN4 and AN5 bolts in lengths from 3/8" to 2-3/4" with drilled and undrilled shanks, in quantities selected to accommodate popular usage. Furnished with a 44-drawer storage cabinet. An exceptionally fine value..... P/N 04-00200 ...\$427.95

Part No.	Qty.	Length	1/4" Dia., Undrilled Shank		
3/16" Dia., Undrilled Shank					
AN3-3A	10	3/8"	AN4-10A	24	1"
AN3-4A	15	1/2"	AN4-11A	12	1-1/8"
AN3-5A	25	5/8"	AN4-12A	12	1-1/4"
AN3-6A	25	3/4"	AN4-13A	12	1-3/8"
AN3-7A	12	7/8"	AN4-14A	12	1-1/2"
AN3-10A	30	1"	AN4-15A	12	1-5/8"
AN3-11A	30	1-1/8"	AN4-16A	12	1-3/4"
AN3-12A	30	1-1/4"	AN4-17A	12	1-7/8"
AN3-13A	20	1-3/8"	AN4-22A	6	2-1/4"
AN3-14A	20	1-1/2"	AN4-24A	6	2-1/2"
AN3-15A	20	1-5/8"	AN4-26A	6	2-3/4"
AN3-16A	20	1-4/3"	1/4" Dia., Drilled Shank		
AN3-17A	20	1-7/8"	AN4-6	10	3/4"
AN3-20A	12	2"	AN4-7	10	7/8"
3/16" Dia., Drilled Shank			AN4-10	10	1"
AN3-5	15	5/8"	AN4-12	10	1-1/4"
AN3-6	20	3/4"	AN4-16	6	1-3/4"
AN3-7	20	7/8"	AN4-20	6	2"
AN3-10	20	1"	5/16" Dia. Undrilled Shank		
AN3-12	10	1-1/4"	AN5-6A	6	3/4"
AN3-15	10	1-5/8"	AN5-10A	8	1"
AN3-20	8	2"	AN5-12A	6	1-1/8"
AN3-24	8	2-1/2"	AN5-16A	6	1-3/4"
1/4" Dia., Undrilled Shank			5/16" Dia. Drilled Shank		
AN4-5A	24	5/8"	AN5-7	6	7/8"
AN4-6A	24	3/4"	AN5-14	6	1-1/2"
AN4-7A	24	7/8"	AN-17	6	1-7/8"
			AN5-24	6	2-1/2"

DELUXE WASHER & COTTER PIN PACK

2000 WASHERS, 700 COTTER PINS - 31 Items, individually packaged. A combination of flat washers in steel and anodized aluminum, regular and light weight, large-area washers, internal locking type, Tinnerman countersunk washers and six useful sizes of cotter pins. 26 Drawer hardware cabinet included. P/N 04-00300\$284.95

Part No.	Qty.	Size	Part No.	Qty.	Size
Steel, Regular Flat			Steel, Large Flat (cont'd.)		
AN960-6	100	#6	AN970-5	11	5/16"
AN960-8	100	#8	Steel, Internal Lock		
AN960-10	250	3/16"	MS35333-37	50	#6
AN960-416	200	1/4"	MS35333-38	50	#8
AN960-516	100	5/16"	MS35333-39	50	#10
Steel, Light Flat			MS35333-40	50	1/4"
AN960-6L	100	#6	MS35333-41	50	5/16"
AN960-8L	100	#8	Tinnerman Countersunk		
AN960-10L	100	3/16"	A3236-012-24A	100	#6
AN960-416L	100	1/4"	A3135-017-24A	100	#8
AN960-516L	50	5/16"	A3235-028-24A	100	#10
Anod. Alum. Regular Flat			Cotter Pins		
AN960PD10	50	3/16"	Part No.	Qty.	Size
AN960PD416	50	1/4"	MS24665-132	225	1/16" x 1/2"L
Anod. Alum. Light Flat			MS24665-134	200	1/16" x 3/4"L
AN960PD10L	50	3/16"	MS24665-136	200	1/16" x 1"L
AN960PD416L	50	1/4"	MS24665-283	50	3/32" x 3/4"L
Steel, Large Flat			MS24665-285	13	3/32" x 1"L
AN970-3	25	3/16"	MS24665-360	12	1/8" x 2"L
AN970-4	14	1/4"			

ASSORTED HARDWARE KITS HOMEBUILDERS HARDWARE KIT

Contains: • 78 AN3 (10-32 size) Undrilled bolts in 13 consecutive sizes from AN3-4A through AN3-20A • 66 AN4 (1/4" dia.) Undrilled Bolts in 11 consecutive sizes from AN4-6A through AN4-20A • 100 AN365-1032 Stop Nuts • 100 AN365-428 Stop Nuts • 100 AN960-10 Washers • 100 AN960-416 Washers • 100 AN380-2-2 Cotter Pins

P/N 04-00400 \$105.95
With 26-Drawer Storage Cabinet..... P/N 04-00500 \$174.95

MECHANICS HARDWARE KIT

Contains: • AN3 (10-32 size) Bolts from 1/2" to 3" long • AN4 (1/4" dia.) Bolts from 1" to 4" long • AN5 (5/16" dia.) Bolts from 1" to 4" long • AN6 (3/8" dia.) Bolts from 1-3/4" to 4-1/2" long • 300 AN960 Washers • 75 AN365 Stop Nuts • 100 AN380 Cotter Pins. Bolts are furnished with drilled and undrilled shanks. The proper number, size and type of nuts, washers and cotter pins are furnished to mate with bolts. Click "Expanded Kit Components" for a complete hardware list.

P/N 04-00600 \$322.95
With (1) 26 & (1) 64 -Drawer Storage Cabinets
P/N 04-00700 \$486.95

DELUXE SCREW PACK

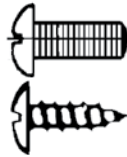

3500 SCREWS - 55 Items, individually packaged. A good working assortment of standard screws including truss head, 100° flat head and structural type, washer head, 100° flat head sheet metal screws for use with Tinnerman countersunk washers, truss head sheet metal screws, both sharp and blunt point, & brass instrument screws. 44-Drawer cabinet included.

P/N 04-00800 \$507.00

Part No.	Qty.	Size	AN509 Structural Screws	Qty.	Size
AN 526 Truss Hd Screw, Phillips					
AN526-632R6	100	6-32 x 3/8"	MS24694S5	25	8-32 x 1/2"
AN526-632R8	100	x 1/2"	MS24694S7	25	x 5/8"
AN526-632R10	100	x 5/8"	MS24694S9	25	x 3/4"
AN526-632R12	100	x 3/4"	MS24694S50	25	10-32 x 1/2"
AN526-832R6	100	8-32 x 3/8"	MS24694S52	25	x 5/8"
AN526-832R8	100	x 1/2"	MS24694S54	25	x 3/4"
AN526-832R10	100	x 5/8"	Washer Head Structural Screws		
AN526-832R12	100	x 3/4"	AN525-832R8	25	8-32 x 1/2"
AN526-1032R8	100	10-32 x 1/2"	AN525-832R10	25	x 5/8"
AN526-1032R10	100	x 5/8"	AN525-1032R8	25	10-32 x 1/2"
AN526-1032R12	100	x 3/4"	AN525-1032R10	25	x 5/8"
AN526-1032R16	50	x 1"	AN525-1032R12	25	x 3/4"
AN507 Screws					
100° C snk Flat Head Phillips					
MS2469326	100	6-32 x 3/8"	Sheet Metal Screws		
MS24693S28	100	x 1/2"	100° C snk Flat Head Phillips		
MS24693S29	100	x 5/8"	NAS548P-6	100	#6 x 3/8"
MS24693S10	100	x 3/4"	NAS548P-8	100	x 1/2"
MS24693S31	100	x 7/8"	NAS548P-10	100	x 5/8"
MS24693S48	100	8-32 x 3/8"	NAS548P-8	100	#8 x 1/2"
MS24693S50	100	x 1/2"	NAS548P-10	100	x 5/8"
MS24693S51	100	x 5/8"	Sheet Metal Screws, Truss Hd "B"		
MS24693S52	100	x 3/4"	#4R x 1/4"	100	Phillips
MS24693S54	50	x 1"	#4R x 3/8"	100	Blunt Point
MS24693S58	25	x 1-1/2"	#4R x 1/2"	100	
MS24693S272	100	x 1/2"	#6R x 3/8"	100	
MS24693S273	100	x 5/8"	#6R x 1/2"	100	
MS24693S274	100	x 3/4"	#6R x 5/8"	100	
MS24693S276	50	x 1"	#8R x 1/2"	100	
MS24693S280	25	x 1-1/2"	#8R x 3/4"	100	
Brass Instrument Screws					
Round Head Phillips					
AN515B6R12	25	6-32 x 3/4"	Sheet Metal Screws, Truss Hd "A"		
			#4R x 1/2"	200	Phillips
			#6R x 1/2"	200	Sharp Point

DELUXE NUT PACK



1000 NUTS - 29 Items, individually packaged. NUTS have been carefully selected to include every commonly used type in aircraft assembly - Self-locking, castle, plain hex, Pal, Tinnerman and all-metal two-lug anchor nuts not found in other hardware assortments. 26-Drawer Cabinet Included P/N 04-00900.....\$468.95

Part No.	Qty.	Size	AN315-4	25	1/4 x 28
Elastic Stop Nuts					
AN365-632A	25	6-32	AN315-5	25	5/16 x 24
AN365-832A	25	8-32	Check Nuts		
AN365-1032A	75	10-32	AN315-3	25	10-32
AN365-428A	50	1/4 x 28	AN316-4	25	1/4 x 28
AN365-524A	25	5/16 x 24	Palnuts		
All Metal Stop Nuts					
MS21042-3	75	10-32	MS27151-7	25	10-32
MS21042-4	25	1/4 x 28	MS27151-13	25	1/4 x 28
Tinnerman Nuts, Flat Type					
Castle Nuts					
AN310-3	50	10-32	#1777-6Z-1	50	#6
AN310-4	50	1/4 x 28	#1778-8Z-1	50	#8
AN310-5	14	5/16 x 24	#1779-10Z-1	25	#10
Shear Castle Nuts					
AN320-3	12	10-32	#1784-6Z-1	50	#6
AN320-4	12	1/4 x 28	#A1932-8Z-1	50	#8
AN320-5	12	5/16 x 24	Two Lug Anchor Nuts		
Plain Hex Nuts					
AN315-3	25	10-32	K1000-8	50	8-32
			K1000-3	50	10-32
			K1000-4	25	1/4 x 28

HARDWARE CABINETS

Heavy-duty small parts organizer cabinets. The "see-thru" clear plastic drawers measure 1-1/4" x 2-3/4" x 5-3/4". The plastic cabinets are black. Furnished with adjustable drawer dividers. 16 drawer is white plastic.

CABINETS

16-Drawer P/N 04-01464 \$52.75
26-Drawer P/N 04-01465 \$68.75
44-Drawer P/N 04-01466 \$99.75
Lg Dividers (25) P/N 40-501 \$8.75

PORTABLE ORGANIZERS

11-46 compartments P/N 04-01469 \$81.85
64-Drawer P/N 04-01467 \$95.75
Lg Dividers (6) P/N 04-02039 \$13.60
Sm Dividers (16) P/N 04-02037 \$25.50

HA

AIRFRAME NUTS

AN310 CASTLE, AN320 SHEAR NUTS

Fabricated from steel & cadmium plated per QQ-P-416, Type II, Class 2. AN310 castle nuts are used with drilled-shank bolts, clevis bolts, eye bolts and studs. The slots in the nut accommodate a cotter pin for safety purposes. The thinner AN320 castellated shear nut, with half tensile rating of the AN310 nut, used with clevis bolts & threaded taper pins which are subject to shearing stress only.

AN310, AN320 Dash No.	Thread Size	Cotter Pin Size	AN310 Cad Plated Nuts Price	AN310C Stainless Nuts	AN320 Cad Plated Each	AN320C Stainless Nuts
-3	10-32	AN380-2-2	\$1.00	\$1.36	\$1.07	\$1.10
-4	1/4-28		\$1.36	\$1.75	\$1.16	\$1.65
-5	5/16-24		\$1.31	\$1.84	\$1.45	\$1.69
-6	3/8-24	AN380-3-3	\$1.61	\$2.60	\$1.99	\$2.31
-7	7/16-20		\$2.65	\$4.35	\$1.47	\$4.85
-8	1/2-20		\$4.90	\$9.50	\$2.27	\$3.75
-9	9/16-18	AN380-4-4	\$13.50	---	\$3.35	---
-10	5/8-18		\$2.76	---	\$4.35	\$9.50
-12	3/4-16	AN380-4-5	\$4.43	---	\$4.95	\$7.95

AN315 FULL HEX, AN316 THIN CHECK NUTS

Fabricated from steel and cadmium plated per QQ-P-416, Type II, Class 2. The AN315 plain hex nut is of rugged construction and can carry the same high tension load as the AN310 castle nut. It requires an auxiliary locking device such as a check nut or lock washer. AN316 hex check nuts can carry half the tension load of the AN315 nut. They are used as a locking device for plain nuts, set screws, rod ends, etc. Order by AN number. Add R or L after dash number for right-hand or left-hand thread.

Example: AN316-5L is a thin check nut with 5/16-24 left-hand thread.

AN315	Price Ea.		Thread Size	AN316	Price Ea.	
	R	L			R	L
-640	\$0.88	\$0.78	6-40	None	None	None
-3	\$0.08	\$0.45	10-32	None	None	None
-4	\$0.15	\$0.34	1/4-28	-4	\$0.13	\$0.36
-5	\$0.13	\$0.46	5/16-24	-5	\$0.20	\$0.49
-6	\$0.19	\$0.66	3/8-24	-6	\$0.17	\$0.53
-7	\$0.68	\$2.18	7/16-20	-7	\$0.37	\$0.63
-8	\$1.29	---	1/2-20	-8	\$0.44	\$1.23
-9	\$2.53	---	9/16-18	-9	\$2.27	---

HEX NUT - LOW HEIGHT

Heat treated, cadmium plated steel with dry film lubricant applied. Self-locking. Standard temp. to 450°F.

Thread Size	NAS No.	Part No.	Price Ea.	Thread Size	NAS No.	Part No.	Price Ea.
6-32	679-A06	04-00143	\$1.06	1/4-28	679-A4	04-00147	\$0.99
8-32	679-A08	04-00144	\$0.83	5/16-24	679-A5	04-00148	\$3.25
10-32	679-A3	04-00146	\$0.64	3/8-24	679-A6	04-00149	\$3.40

CAP NUTS ("ACORN NUTS")

Use these solid brass cap nuts to attach instrument panels to stud-type shock mounts. Give the panel an attractive, finished appearance and do not introduce magnetic interference.

Part No.	Thread Size	Price Ea.	Part No.	Thread Size	Price Ea.
AC632	6-32	\$0.47	AC1032	10-32	\$0.75
AC832	8-32	\$0.56	AC1428	1/4-28	\$1.45

AN345 PLAIN HEX MACHINE SCREW NUT

Fine Thread Thread	Cad-Plated Cat.#	Price	Stainless Cat.#	Price
10-32	AN345-10	\$0.08	AN345C10	\$0.29
1/4-28	AN345-428	\$0.13	AN345C428	\$0.59
5/16	AN345-524	\$0.24		
3/8-24	AN345-624	\$0.58		

ZINC TEE NUTS

Here's an easy way to put steel threads in wood, plastic, or particleboard. Just drill a hole to fit the barrel, insert tee nut, and hammer in the locking prongs until the base of the tee nut is flush with the surface. Right-hand thread.

Size	Barrel Length	Part No.	Price
8-32	1/4"	04-02056	\$0.34
10-32	5/16"	04-02057	\$0.36
5/16-18	1/2"	04-01697	\$2.15
1/4-20	7/16"	04-02058	\$0.47

AN340 PLAIN HEX MACHINE SCREW NUT

Coarse Thread - Use brass type for instruments.

Thread	Dash#	AN340 Cad-Plated Price	AN340C Stainless Price	AN340B Brass Price
4-40	-4	\$0.11	\$0.23	\$0.51
6-32	-6	\$0.10	\$0.22	\$0.37
8-32	-8	\$0.08	\$0.28	\$0.58
10-24	-10	\$0.14	\$1.89	\$0.91

AN350 WING NUTS

AN350 WING NUTS Fabricated from carbon steel and cadmium plated per specification QQ-P416A, Type II, Class 3. Tensile strength 50,000 PSI. A .070" hole is drilled in one wing for safety wire.

Dash No.	Thread Size	Price Each	Dash No.	Thread Size	Price Each
-632	3-32	---	-4	1/4-28	\$7.90
-832	8-32	---	-5	5/16-24	---
-1032	10-32	\$7.50			

MS27151 PAL NUTS

MS27151 engine nuts replace AC356 Pal nuts. They are stamped from 1050 spring steel and cadmium plated per QQ-P-416A, Type II, Class 2.

Dash No.	Thread Size	Price Each	Dash No.	Thread Size	Price Each
-13	1/4-28	\$0.18	-21	7/16-20	\$0.35
-16	5/16-24	\$0.18	-24	1/2-20	\$0.28
-19	3/8-24	\$0.20			

MS17825 SELF-LOCKING CASTLE NUTS

Manufactured to standard castle or shear nut specifications with a nylon insert added for positive safety. Use it throughout the control system. Should the cotter pin used with castle nuts be overlooked, the nut cannot work loose. The nylon insert will act as a stop nut.

Dash No.	Thread Size	Price Each	Dash No.	Thread Size	Price Each
-3	10-32	\$1.38	-6	3/8-24	\$1.98
-4	1/4-28	\$2.15	-7	7/16-20	\$2.84
-5	5/16-24	\$2.03			

MS17826 SELF LOCKING NUTS

MS17826 Nylon Hex Nut. Self-Locking Nut, Castellanated, Hexagon, 250 Deg.F, Thin, Non-Metallic Insert Material- Alloy Steel, Finish-CAD Per QQ-P-416 Type II.

Model	Part No.	Steel Dash#	Thread Size	A Dim	B Dim	Price
MS17826-3	04-01367	3	10-32	.173-.203	.367-.376	\$1.66
MS17826-4	04-01368	4	1/4-28		.430-.439	\$1.62
MS17826-5	04-01369	5	5/16-24	.204-.234	.492-.502	\$1.94
MS17826-6	04-01370	6	3/8-24		.553-.564	\$2.25
MS17826-7	04-01371	7	7/16-20		.679-.690	\$2.99
MS17826-8	04-01372	8	1/2-20	.235-.265	.741-.752	\$3.20

EXHAUST MANIFOLD NUTS

Part No.	Thread Size	Type	Engine Application	Price Each
STD1410	5/16-18	Steel	Lycoming	\$1.95
STD1411	1/4-20	Steel	Lycoming	\$3.70

MS21042 HEX NUTS (LUBED)

These are the same as MS21042- but have a dry film lube (dark grey).

Dash No.	Thread Size	Price Each	Dash No.	Thread Size	Price Each	Dash No.	Thread Size	Price Each
-L06	6-32	\$0.45	-L3	10-32	\$0.36	-L5	5/16-24	\$0.88
-L08	8-32	\$0.42	-L4	1/4-28	\$0.35	-L6	3/8-24	\$0.93

MS21043 HEX NUTS (STAINLESS STEEL)

These are the same as MS21042 but are made from A-286 stainless steel and are silver plated.

Dash No.	Thread Size	Price Each	Dash No.	Thread Size	Price Each	Dash No.	Thread Size	Price Each
-04	4-40	\$0.87	-3	10-32	\$0.56	-5	5/16-24	\$1.73
-06	6-32	\$0.61	-4	1/4-28	\$0.74	-6	3/8-24	\$2.75
-08	8-32	\$0.74						

STOP NUTS – ANCHOR NUTS



AN363
MS21045
NAS1021A



MS21042

AN363 & MS21042 ALL METAL STOP NUTS

The AN363 and MS21042 all-metal stop nuts are designed for use in high temperature installations (up to 450°F). The MS21042 nuts are shorter than the AN363 nut but develop the same tensile strength. Fabricated from carbon steel and cadmium plated per specification QQ-P-416C.

AN363 CAD Plated Dash No.	Price Each	AN363C Stainless Dash No.	Price Each	Thread Size	MS21042 Dash No.	Price Each
-632	\$1.15	-632	\$1.66	6-32	-06	\$0.43
-832	\$0.64	-832	\$1.44	8-32	-08	\$0.30
-1032	\$0.88	-1032	\$1.22	10-32	-3	\$0.26
-428	\$0.90	-428	\$1.83	1/4-28	-4	\$0.34
-524	\$0.69	-524	\$2.40	5/16-24	-5	\$1.15
-624	\$1.79	-624	\$4.35	3/8-24	-6	\$0.87
-720	\$2.47	---	---	7/16-20	-7	---
-820	\$2.64	---	---	1/2-20	-8	---
-918	\$4.60	---	---	9/16-18	-9	---

AN364, AN365 ELASTIC STOP NUTS



AN364
MS21083
NAS1022N



AN365
MS21044
NAS1021N

These precision-made nuts are reliable and economical fastening devices. The nylon insert gives a friction grip on the threads of the bolt and holds securely. The AN364 (thin) stop nut is for use in structural applications where the bolt is loaded primarily in shear or in any application where the tensile strength of the regular height AN365 is not required. Cad stop nuts are furnished to military specifications. Insert color designates manufacturer only.

Dash No.	Thread Size	Price Ea.		Dash No.	Thread Size	Price Ea.	
		AN364	AN365			AN364	AN365
-440A	4-40	\$0.44	---	-524A	5/16-24	\$0.56	\$0.27
-440	4-40	---	\$0.41	-624A	3/8-24	\$1.14	\$0.39
-632A	6-32	\$0.32	\$0.37	-720A	7/16-20	\$1.68	\$1.09
-832A	8-32	\$0.16	\$0.18	-820A	1/2-20	\$1.59	\$0.72
-1024A	10-24	---	\$0.29	-918A	9/16-18	\$3.35	\$2.47
-1032A	10-32	\$0.20	\$0.18	-1018A	5/8-18	\$1.98	\$1.19
-428A	1/4-28	\$0.13	\$0.19	-1216A	3/4-16	\$2.10	\$3.55

NSWC ELASTIC STOP NUT KIT

Contains: • AN364-428A (20 qty) • AN364-918A (4 qty) • AN364-624A (22 qty) • AN364-720A (4 qty) • AN364-820A (32 qty)

P/N 04-01729 \$99.00

AN364, AN365 STAINLESS STOP NUTS

Thread	Part No.	Price	Thread	Part No.	Price
1/4-28	AN364C-428	\$1.32	1/4-28	AN365C-428	\$1.03
3/8-24	AN364C-624	\$1.57	5/16-24	AN365C-524	\$1.22
632	AN364C-632	\$0.56	3/8-24	AN365C-624	\$1.77
7/16-20	AN364C-720	\$5.80	6-32	AN365C-632	\$0.46
1/2-20	AN364C-820	\$3.35	7/16-20	AN365C-720	\$2.63
8-32	AN364C-832	\$0.88	1/2-20	AN365C-820	---
9/16-18	AN364C-918	\$8.50	8-32	AN365C-832	\$0.61
5/8-18	AN364C-1018	\$5.35	5/8-18	AN365C-1018	\$7.50
10-32	AN364C-1032	\$1.13	10-32	AN365C-1032	\$0.39



MS21044 / MS21083 STAINLESS STOP NUTS

Part Number	Bolt Size	Price Ea.	Part Number	Bolt Size	Price Ea.
MS21044C04	#4	\$0.82	MS21083C4	1/4	\$0.57
MS21044C10	5/8	\$7.50	MS21083C7	7/16	\$5.80
MS21083C9	9/16	\$8.50	MS21083C8	1/2	\$3.35
			MS21083C10	5/8	\$5.35

STAINLESS STOP NUTS

Dash No.	Thread Size	Price Ea.		Dash No.	Thread Size	Price Ea.	
		Com364	Com365			Com364	Com365
-440	4-40	\$0.09	\$0.07	-624	3/8-24	\$0.21	\$0.36
-632	6-32	\$0.08	\$0.06	-720	7/16-20	\$1.65	\$0.52
-832	8-32	\$0.09	\$0.06	-820	1/2-20	\$1.89	\$0.74
-1024	10-24	---	---	-918	9/16-18	---	---
-1032	10-32	\$0.16	\$0.08	-1018	5/8-18	---	\$1.37
-428	1/4-28	\$0.21	\$0.15	-1216	3/4-16	---	---
-524	5/16-24	\$0.27	\$0.18				

ANCHOR NUTS

Anchor nuts are designed for blind mounted applications where it is impractical to use hex nuts or where it is desirable to have an attached nut for ease of maintenance. Use 3/32" dia. rivets with nut sizes 632, 832, 1032 and 428. Use 1/8" dia. rivets with 524 and 624.

TWO LUG ANCHOR NUTS



AN366F
NA1, MS21078,
NAS1023N



K1000
MS21047, NAS680S,
NAS1023A



MK1000
MS21069, NAS697N

ELASTIC-INSERT ANCHOR NUT

Part No.	Thread Size	Price Each	Part No.	Thread Size	Price Each
MS21078-06	6-32	\$13.38	AN366F-428A	1/4-28	\$3.90
AN366F-524A	8-32	-	AN366F-524	5/16-24	-
AN366F-1032A	10-32	\$4.65			

ALL METAL ANCHOR NUT

Dash No.	Thread Size	K1000 (Full Size)	MK1000 (Miniature)	(Dimpled Rivet Holes) MS21047
		Price Ea.	Price Ea.	Price Ea.
04	4-40	---	\$0.74	---
06	6-32	\$0.60	\$0.73	\$1.60
08	8-32	\$0.50	\$0.47	---
3	10-32	\$0.48	\$0.66	\$1.08
-4	1/4-28	\$0.93	\$0.91	---
-5	5/16-24	\$2.35	---	---
-6	3/8-24	\$2.47	---	---

ONE LUG ANCHOR NUTS



NA17
MS21080, NAS1025N



MK2000
MS21071, NAS696A

Elastic-Insert Anchor Nut		Thread Size	All-Metal Anchor Nut	
Part No.	Price Each		Dash No.	Price Each
		6-32	L06	MS21051 (Full Size) \$0.97
			L08	MS21071 (Miniature) \$0.71
			L3	\$0.72 \$0.86
MS21080-3	\$21.50	10-32	L4	\$0.92 \$0.79
		1/4-28		\$1.35 \$1.19



ANCHOR NUT, DIMPLED, STANDARD SIZE

Anchor Nut, Dimpled Standard Size

K1100-06 6-32 Thread P/N 04-01724 \$3.35
K1100-08 8-32 Thread P/N 04-01725 \$0.62

Anchor Nut, One Leg, Dimpled, Standard size

MS21053-L08 8-32 Thread P/N 04-01726 \$1.79



NA5
MS21081
NAS1027N



CORNER NUTS



K3000
MS21055
NAS684A
NAS1027A

All-Metal Anchor Nut	Price Ea.	Size	Anchor Nut	Price Ea.
MS21081-3	\$20.75	8-32	MS21055L08	\$1.20
		10-32	MS21055L3	\$1.27
		1/4-28	MS21055L4	\$1.51



RIGHT ANGLE FLOATING NUTS

Part No.	Thread Size	Price Ea.
22NA27-22-62	6-32	\$19.70
22NA27-22-82	8-32	---

NA27 (AN256F)

TWO LUG MINI ANCHOR NUTS

Part Number	Thread Size	Price Each
MS21075L06	6-32	\$0.89
MS21075L08	8-32	\$0.86
MS21075L3	10-32	\$0.58



F5000
MS21059

ALL-METAL FLOATING ANCHOR NUTS



F2000
MS21061

Two-Lug Nut	Price Ea.	Thread Size	One-Lug Nut	Price Ea.
---	---	4-40	MS21061-04	\$2.26
MS21059L06	\$0.64	6-32	MS21061L06	\$1.33
MS21059L08	\$0.78	8-32	MS21061L08	\$0.87
MS21059L3	\$0.53	10-32	MS21061L3	\$0.96
MS21059L4	\$1.08	1/4-28	MS21061-L4	\$1.10

HA

HEX NUTS – SPACERS – INSERTS



NAS509 DRILLED HEX NUTS

Material - 4130 Alloy Steel Per AMS-S-6758.
Finish - Cad Type II, Class 2 Per AMS-QQ-P-416.
Heat Treat- 150 KSI Min Per AMS2759.
Hardness - 34-38 HRC

Thread Dash	Thread Size	Part No.	Price
RH - 4	1/4-28 UNJF-3B	NAS509-4	\$7.80
RH - 5	5/16-24 UNJF-3B	NAS509-5	\$3.00
RH - 6	3/8-24 UNJF-3B	NAS509-6	\$4.60
RH - 7	7/16-20 UNJF-3B	NAS509-7	\$3.20
RH - 8	1/2-20 UNJF-3B	NAS509-8	\$4.60
LH - L4	1/4-28 UNJF-3B	NAS509L4	\$2.50
LH - L5	5/16-24 UNJF-3B	NAS509L5	\$3.00
LH - L6	3/8-24 UNJF-3B	NAS509L6	\$3.70
LH - L7	7/16-20 UNJF-3B	NAS509L7	\$3.90
LH - L8	1/2-20 UNJF-3B	NAS509L8	\$4.20



NAS671 HEX NUT

Hex Nuts, Small Pattern - NAS671
Material - Carbon Steel
Finish - Cad Type II Per QQ-P-416

Thread Size	A Dim	T Dim	Part No.	Price
6-32	.241-.250	.087-.098	04-03004	\$0.15
8-32	.302-.313	.102-.114	04-03005	\$0.16
10-32	.332-.344	.117-.130	04-03006	\$0.18



NAS1423 DRILLED HEX NUTS

Material - 4130 Alloy Steel Per AMS-S-6758
Finish - Cad Type II, Class 2 Per AMS-QQ-P-416
Heat Treat- 150 KSI Min Per AMS2759
Hardness - 34-38 HRC

Thread Dash	Thread Size	Part No.	Price
RH-4	1/4-28 UNJF-3B	NAS1423-4	\$4.75
RH-5	5/16-24 UNJF-3B	NAS1423-5	\$3.40
RH-6	3/8-24 UNJF-3B	NAS1423-6	\$4.80
RH-7	7/16-20 UNJF-3B	NAS1423-7	\$4.00
RH-8	1/2-20 UNJF-3B	NAS1423-8	\$6.50
LH-4LH	1/4-28 UNJF-3B	NAS1423-4LH	\$7.60
LH-5LH	5/16-24 UNJF-3B	NAS1423-5LH	\$4.85
LH-6LH	3/8-24 UNJF-3B	NAS1423-6LH	\$3.90



NAS43DD3 SPACERS

NAS43DD3-10FC Spacers.

Material - 2024 Aluminum
Finish - Chemical Film

For #10 (190) Screws

Manufacturer Part No.	Length	Part No.	Price
NAS43DD3-10FC	0.156 = 5/32	04-02990	\$0.19
NAS43DD3-12FC	0.188 = 3/16	04-02991	\$0.27
NAS43DD3-16FC	0.250 = 1/4	04-02992	\$0.25
NAS43DD3-24FC	0.375 = 3/8	04-02993	\$0.32
NAS43DD3-32FC	0.500 = 1/2	04-02994	\$0.54
NAS43DD3-40FC	0.625 = 5/8	04-02995	\$0.40
NAS43DD3-48FC	0.750 = 3/4	04-02996	\$0.48
NAS43DD3-56FC	0.875 = 7/8	04-02997	\$0.78
NAS43DD3-64FC	1.000 = 1	04-02998	\$0.76



6-32 BRASS INSTRUMENT STOP-NUT

6-32 Brass Instrument Stop-Nut.
P/N MS21044B06.....\$1.54



MS35649 & MS35650 HEX MACHINE NUTS

Material - Stainless Steel, Brass - Tin Plated,
CAD Plated Carbon Steel Finish

Manufacturer Part No.	Thread Size	Material	Part No.	Price
MS35649-224	2-56	Stainless Steel	04-01357	\$0.33
MS35649-286T	8-32	Brass - Tin Plated	04-01393	\$0.61
MS35650-305T	10-32	Brass - Tin Plated	04-01394	\$0.35
MS35649-2252	1/4-20	CAD Plated Carbon Steel	04-01396	\$0.20
MS35649-2312	5/16-18	CAD Plated Carbon Steel	04-01397	\$0.39



AN121501 - AN121504 HEX NUTS

Hex Nuts - AN121501 - AN121504
Material - Alloy Steel Per AMS6322
Finish - Cad Per AMS2400

Manufacturer Part No.	Thread Size	A Dim	T Dim	Part No.	Price
AN121501	10-32	.367-.376	0.156	04-02999	\$1.78
AN121502	1/4-28	.430-.439	.219	04-03001	\$2.02
AN121503	5/26-24	.492-.502	.266	04-03002	\$2.60
AN121504	3/8-24	.533-.564	.328	04-03003	\$4.50



SELF LOCKING SCREW THREAD INSERTS

Screw Thread Inserts - Self Locking
Material - Stainless Steel Per NASM8846
Finish - Plain, Dyed Red Or Dry Film Lube (L) Per AS5272

Material	Thread Size	Nominal Diameter	Nominal Length	Part No.	Price
Dyed Red	4-40	0.112	0.112	MS21209C0410	\$0.18
Dyed Red	4-40	0.112	0.168	MS21209C0415	\$0.18
Dyed Red	4-40	0.112	0.224	MS21209C0420	\$0.18
Dyed Red	6-32	0.138	0.138	MS21209C0610	\$0.26
Dyed Red	6-32	0.138	0.207	MS21209C0615	\$0.18
Dyed Red	6-32	0.138	0.276	MS21209C0620	\$0.24
Dyed Red	8-32	0.164	0.164	MS21209C0810	\$0.18
Dyed Red	8-32	0.164	0.246	MS21209C0815	\$0.18
Dyed Red	8-32	0.164	0.328	MS21209C0820	\$0.18
Dyed Red	10-32	0.190	0.190	MS21209F1-10	\$0.18
Dyed Red	10-32	0.190	0.285	MS21209F1-15	\$0.18
Dyed Red	10-32	0.190	0.380	MS21209F1-20	\$0.18
Dyed Red	1/4-28	0.250	0.250	MS21209F4-10	\$0.18
Dyed Red	1/4-28	0.250	0.375	MS21209F4-15	\$0.18
Dyed Red	1/4-28	0.250	0.500	MS21209F4-20	\$0.18
Dry Film Lube	4-40	0.112	0.112	MS21209C0410L	\$0.22
Dry Film Lube	4-40	0.112	0.168	MS21209C0415L	\$0.22
Dry Film Lube	6-32	0.138	0.138	MS21209C0610L	\$0.22
Dry Film Lube	6-32	0.138	0.207	MS21209C0615L	\$0.22
Dry Film Lube	8-32	0.164	0.164	MS21209C0810L	\$0.22
Dry Film Lube	8-32	0.164	0.246	MS21209C0815L	\$0.22
Dry Film Lube	10-32	0.190	0.190	MS21209F1-10L	\$0.22
Dry Film Lube	10-32	0.190	0.285	MS21209F1-15L	\$0.22
Dry Film Lube	10-32	0.190	0.380	MS21209F1-20L	\$0.25

HA

INSTRUMENT AND SHEET NUTS

NUTS FOR SHEET METAL SCREWS



"B"-type Sheet Metal Screw

These speed nuts are self-locking steel fasteners. Locking action is derived from the force exerted by the two arched prongs against the root of the screw thread and by the spring tension of the prongs and base. The combined forces of the thread lock and spring tension provide a vibration proof fastening. Speed nuts retain their spring tension and may be used repeatedly without losing their self-locking effectiveness. Suitable for numerous non-structural applications.

Finish: Phosphate-coated with three coats of olive drab paint.

Important: Speed nuts for aircraft are designed to fit standard AN530-AN531 type B sheet metal screws only. Do not use pointed type A sheet metal screws with aircraft Speed nuts. There is a difference in root diameter and thread pitch. Screw lengths: B type sheet metal screws have a blunt taper at the end. To be certain the fastener prongs grip on the full root diameter, the screw should protrude two to three threads beyond the prongs. See the illustration.

"U" TYPE (NAS 395) CLIP NUTS

Snaps over edge of panels or into center hole locations. Holds itself in place for blind assembly. "Floats" free for easy hole alignment.

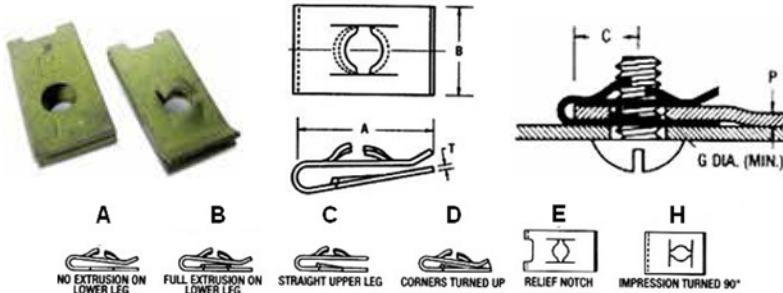

A NO EXTRUSION ON LOWER LEG
B FULL EXTRUSION ON LOWER LEG
C STRAIGHT UPPER LEG
D CORNERS TURNED UP
E RELIEF NOTCH
H IMPRESSION TURNED 90°

Part Number	Type B Screw Size	Design Variation	P-panel Thickness Range	A Length	B Width	C-max. Center of Hole to Edge	G-Panel Hole Dia.	T Material Thickness	Price
A1784-6Z-1D	#6	E	.025-.051	0.61	0.44	0.281	0.250	0.025	\$0.33
A1785-6Z-1D	#6	E	.025-.064	0.84	0.44	0.500	0.281	0.025	\$0.36
A1789-8Z-1D	#8	E	.025-.051	0.61	0.44	0.281	0.250	0.028	\$0.29
A1787-8Z-1D	#8	E	.025-.064	0.84	0.44	0.500	0.281	0.028	\$0.44
A1788-8Z-1D	#8	A E	.025-.064	0.84	0.44	0.500	0.170	0.028	\$0.26
A1348-8Z-1D	#8	A E	.025-.064	0.73	0.50	0.343	0.170	0.028	\$0.47
A1786-8Z-1D	#8	C E H	.040-.051	0.53	0.50	0.218	0.250	0.028	\$0.25
A178710Z-1D	#10	E	.025-.064	0.84	0.44	0.500	0.281	0.031	\$0.35
A1758-10Z-1D	#10	E	.081-.094	0.62	0.44	0.281	0.281	0.031	\$0.30

FLAT TYPE (NAS 446)



Used to replace threaded nuts, lock washers, and spanner washers; weigh less than other types of self-locking aircraft fasteners. Can be applied faster, easier, and are vibration resistant. Provide maximum holding power at minimum cost per fastener. Turned-up ends prevent scoring of surfaces. Use with type B tapping screws.

Part No.	Screw Size	Price ea.
A1776-4Z-1D	#4	\$0.21
A1778-8Z-1D	#8	\$0.19
A1779-10Z-1D	#10	\$0.22

HOW TO APPLY SPEED NUT FASTENERS

FLAT TYPE

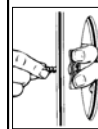

Fastener is positioned over screw clearance hole with screw-engaging prongs pointing up or outward. Screw is started into nut by hand from the underside.

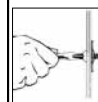

Screw can be power-driven into locked position (when base arch of fastener is flat) or a hand screw driver can be used. No wrench is required, finger pressure will prevent it from turning.

"U" TYPE

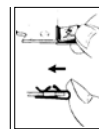

Push into position with thumb until extrusion on lower leg snaps into screw hole. The fastener "floats" in screw-receiving position to correct for normal misalignment in panel mounting holes.

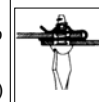

Place second panel in position & drive screw. Access to opposite side is unnecessary. Flush mounting can be made by embossing either panel.

ANCHOR NUTS (NAS 444)

Riveted or welded in position. Attach access plates, doors or any part that must be fastened securely, yet easily removed with fasteners retained in a blind location. Install with AN426AD-3 rivets.



Part No.	Screw Size	Price/Ea.
A6195-6Z-1D	#6	\$0.39
A6195-8Z-1D	#8	\$0.37

LHA 4972 FLOATING CLIPNUT CADMIUM-PLATED STEEL



Part No.	Thread	Price Each
4972-5-62	6-32	\$2.37
4972-6-82	8-32	\$1.95
04-01489	10-32	\$2.25

MONADNOCK CLIP NUTS

High strength Forged hex nuts suitable for structural and non-structural applications in metal, plastic, and composite materials.



Size	Distance	Edge Thickness	Part Number	Price Ea.
6-32	.180-.120	.030-.051	04-00151	\$4.85
8-32	.310-.500	.020-.090	04-00152	\$1.98
10-32	.350-.500	.020-.090	04-00153	\$2.88

INSTRUMENT MOUNTING NUTS

Cage type. Permit mounting of aircraft instruments from the front of the panel. No charge in panel or instrument design required. Non-magnetic (speed nut is brass; cage is phosphor bronze). Conform to MIL-N-3336. Cage is easily compressed with finger-pressure to allow insertion of legs into clearance holes. When fully inserted and pressure is released, legs spring apart; retain SPEED NUT in screw-receiving position. Turned-down corners hold firm against force of inserting screw and screw-tightening torque. All instrument mounting nuts listed below take a 6-32 machine screw.



Tinnerman Part No.	Our Part No.	NAS Part No.	Instrument Thickness	Price Ea.
A8938-632-493	MS33737-9C	487-13	.062	\$1.98
A8939-632-493	MS33737-10C	487-14	.091	\$3.55
A6939-632-493	MS33737-11C	487-15	.125	\$2.36
A8940-632-493	MS33737-12C	487-16	.187	\$3.35
A8941-632-493	MS33737-13C	487-17	.250	\$1.89
A8942-632-493	MS33737-14C	487-18	.313	\$1.75
A8943-632-493	MS33737-15C	487-20	.375	\$2.31
A8944-632-493	MS33737-16C	487-21	over .375	\$3.85

FLOATING CLIP NUT 4972-1032



Reach: .500"
Thread: 10-32
Edge Distance: .375
Material Thickness: .020" - .090
P/N 04-01489\$2.25

HA

MACHINE SCREWS

MS27039 & MS27039C MACHINE SCREWS



Pan head low alloy steel machine screws have 125,000 to 145,000 psi tensile strength with cadmium plate finish to QQ-P-416, Type 2, Class 3.

MS27039C screws are stainless steel Manufactured to MIL-S-6050 or MIL-8695. Equivalent to NAS 220.

Part Number	Diam.-Thrd. Size	Length (In.)	Grip Length (in)	MS27039 Price	MS27039C Price
MS27039-0804	8-32	9/32	---	\$0.16	\$0.38
MS27039-0805	8-32	11/32	---	\$0.10	\$0.48
MS27039-0806	8-32	13/32	---	\$0.13	----
MS27039-0807	8-32	15/32	---	\$0.13	----
MS27039-0808	8-32	17/32	.094	\$0.14	----
MS27039-0809	8-32	19/32	.156	\$0.15	----
MS27039-0810	8-32	21/32	.219	\$0.13	----
MS27039-0811	8-32	23/32	.281	\$0.15	\$0.84
MS27039-0812	8-32	25/32	.344	\$0.18	----
MS27039-0813	8-32	27/32	.406	\$0.14	\$0.87
MS27039-0814	8-32	29/32	.469	\$0.19	\$0.73
MS27039-0815	8-32	31/32	.531	\$0.18	\$0.99
MS27039-0816	8-32	1-1/32	.594	\$0.18	----
MS27039-0817	8-32	1-3/32	.656	\$0.21	\$0.97
MS27039-0818	8-32	1-5/32	.719	\$0.26	----
MS27039-0819	8-32	1-7/32	.781	\$0.22	----
MS27039-0820	8-32	1-9/32	.844	\$0.42	----
MS27039-0821	8-32	1-11/32	.906	\$0.26	----
MS27039-0822	8-32	1-13/32	.969	\$0.22	----
MS27039-0823	8-32	1-15/32	1.031	\$0.23	----
MS27039-0824	8-32	1-17/32	1.094	\$0.28	----
MS27039-1-04	10-32	9/32	---	\$0.15	\$0.84
MS27039-1-05	10-32	11/32	---	\$0.15	\$0.57
MS27039-1-06	10-32	13/32	---	\$0.14	\$0.59
MS27039-1-07	10-32	15/32	---	\$0.12	----
MS27039-1-08	10-32	17/32	.062	\$0.13	----
MS27039-1-09	10-32	19/32	.125	\$0.17	\$0.64
MS27039-1-10	10-32	21/32	.188	\$0.16	\$0.82
MS27039-1-11	10-32	23/32	.250	\$0.17	\$0.79
MS27039-1-12	10-32	25/32	.312	\$0.17	----
MS27039-1-13	10-32	27/32	.375	\$0.20	\$1.17
MS27039-1-14	10-32	29/32	.438	\$0.18	----
MS27039-1-15	10-32	31/32	.500	\$0.19	\$0.98
MS27039-1-16	10-32	1-1/32	.563	\$0.21	----
MS27039-1-17	10-32	1-3/32	.625	\$0.19	\$1.10
MS27039-1-18	10-32	1-5/32	.688	\$0.19	\$1.31
MS27039-1-19	10-32	1-7/32	.750	\$0.32	\$1.34
MS27039-1-20	10-32	1-9/32	.813	\$0.30	\$1.36
MS27039-1-21	10-32	1-11/32	.875	\$0.28	\$1.43
MS27039-1-22	10-32	1-13/32	.938	\$0.27	\$1.50
MS27039-1-23	10-32	1-15/32	1.000	\$0.39	\$2.50
MS27039-1-24	10-32	1-17/32	1.062	\$0.52	\$1.90
MS27039-1-25	10-32	1-19/32	1.125	\$0.53	----
MS27039-1-26	10-32	1-21/32	1.188	\$0.42	----
MS27039-1-27	10-32	1-23/32	1.250	\$0.43	----
MS27039-1-28	10-32	1-25/32	1.312	\$0.43	----
MS27039-1-29	10-32	1-27/32	1.375	\$0.78	----
MS27039-1-30	10-32	1-29/32	1.438	\$0.66	----
MS27039-1-31	10-32	1-31/32	1.500	\$0.48	----
MS27039-1-32	10-32	2-1/32	1.563	\$0.53	----
MS27039-4-06	1/4-28	13/32	---	\$0.29	\$1.73
MS27039-4-07	1/4-28	15/32	---	\$0.24	\$1.20
MS27039-4-08	1/4-28	17/32	---	\$0.21	\$1.22
MS27039-4-09	1/4-28	19/32	.062	\$0.26	\$2.14
MS27039-4-10	1/4-28	21/32	.125	\$0.24	\$1.62
MS27039-4-11	1/4-28	23/32	.188	\$0.30	\$1.14
MS27039-4-12	1/4-28	25/32	.250	\$0.27	\$1.65
MS27039-4-13	1/4-28	27/32	.312	\$0.39	\$2.52
MS27039-4-14	1/4-28	29/32	.375	\$0.32	\$2.15
MS27039-4-15	1/4-28	31/32	.438	\$0.30	\$1.80
MS27039-4-16	1/4-28	1-1/32	.500	\$0.33	\$2.39
MS27039-4-17	1/4-28	1-3/32	.563	\$0.29	----
MS27039-4-18	1/4-28	1-5/32	.625	\$2.20	----
MS27039-4-19	1/4-28	1-7/32	.688	\$0.34	----
MS27039-4-20	1/4-28	1-9/32	.750	\$0.35	----
MS27039-4-21	1/4-28	1-11/32	.813	\$1.27	----
MS27039-4-22	1/4-28	1-13/32	.875	\$0.36	----
MS27039-4-23	1/4-28	1-15/32	.938	\$0.37	----
MS27039-4-24	1/4-28	1-17/32	1.000	\$0.46	----

MS35190 MACHINE SCREWS (CROSS RECESSED)



82° flat head machine screws have 55,000psi minimum tensile strength and feature cadmium plate finish per QQ P-416, Type 2, Class 3. Manufactured from carbon steel to Federal Standard #66.

Part Number	Old AN505R	Diam.-Thrd. Size	Length (In.)	Price
MS35190-221	-4R4	4-40	1/4	\$0.11
MS35190-222	-4R5	4-40	5/16	\$0.39
MS35190-225	-4R8	4-40	1/2	\$0.09
MS35190-226	-4R10	4-40	5/8	\$0.17
MS35190-234	-6R4	6-32	1/4	\$1.75
MS35190-236	-6R6	6-32	3/8	\$0.07
MS35190-238	-6R8	6-32	1/2	\$0.08
MS35190-239	-6R10	6-32	5/8	\$0.08
MS35190-240	-6R12	6-32	3/4	\$0.07
MS35190-250	-8R5	8-32	5/16	\$0.08
MS35190-253	-8R8	8-32	1/2	\$0.08
MS35190-254	-8R10	8-32	5/8	\$0.09

MS35207 MACHINE SCREWS (CROSS RECESSED)



These pan head machine screws have 55,000 psi minimum tensile strength and are cadmium plated to Specification QQ-P-416, Type 2, Class 3. Manufactured from carbon steel per Federal Standard #66.

Part Number	Old AN520R	Dia.-Thread Size	Length (In.)	Price ea.
MS35207-260	-10R5	10-32	5/16	\$0.08
MS35207-261	-10R6	10-32	3/8	\$0.08
MS35207-262	-10R7	10-32	7/16	\$0.11
MS35207-263	-10R8	10-32	1/2	\$0.10
MS35207-264	-10R10	10-32	5/8	\$0.10
MS35207-265	-10R12	10-32	3/4	\$0.11
MS35207-266	-10R14	10-32	7/8	\$0.14
MS35207-267	-10R16	10-32	1	\$0.14
MS35207-268	-10R20	10-32	1-1/4	\$0.13
MS35207-269	-10R24	10-32	1-1/2	\$0.20
MS35207-270	-10R28	10-32	1-3/4	\$0.18
MS35207-271	-10R32	10-32	2	\$0.19

MS35206 MACHINE SCREWS (CROSS RECESSED)



These pan head machine screws feature 60,000 psi minimum tensile strength and are cadmium plated to specification QQ-P-416, Type 2, Class 3. Manufactured from carbon steel to Federal Standard #66, these screws can be used as replacements for AN526 machine screws. Phillips head.

Part Number	Old AN515R	Diam.-Thrd. Size	Length (In.)	Price ea.
MS35206-203	-2R2	2-56	1/4	\$0.07
MS35206-204	-2R5	2-56	5/16	\$0.08
MS35206-205	-2R6	2-56	3/8	\$0.07
MS35206-206	-2R7	2-56	7/16	\$0.06
MS35206-207	-2R8	2-56	1/2	\$0.07
MS35206-208	-2R10	2-56	5/8	\$0.05
MS35206-209	-2R12	2-56	3/4	\$0.09
MS35206-212	-4R3	4-40	3/16	\$0.06
MS35206-213	-4R4	4-40	1/4	---
MS35206-214	-4R5	4-40	5/16	\$0.04
MS35206-215	-4R6	4-40	3/8	\$0.05
MS35206-216	-4R7	4-40	7/16	\$0.07
MS35206-217	-4R8	4-40	1/2	\$0.06
MS35206-218	-4R10	4-40	5/8	\$0.11
MS35206-219	-4R12	4-40	3/4	\$0.06
MS35206-220	-4R14	4-40	7/8	\$0.08
MS35206-221	-4R16	4-40	1	\$0.08
MS35206-222	-4R20	4-40	1-1/4	\$0.17
MS35206-223	-4R24	4-40	1-1/2	\$0.09
MS35206-226	-6R4	6-32	1/4	\$0.05
MS35206-227	-6R5	6-32	5/16	\$0.05
MS35206-228	-6R6	6-32	3/8	\$0.06
MS35206-229	-6R7	6-32	7/16	\$0.06
MS35206-230	-6R8	6-32	1/2	\$0.05
MS35206-231	-6R10	6-32	5/8	\$0.08
MS35206-232	-6R12	6-32	3/4	\$0.08
MS35206-233	-6R14	6-32	7/8	\$0.08
MS35206-234	-6R16	6-32	1	\$0.08
MS35206-235	-6R20	6-32	1-1/4	\$0.09
MS35206-236	-6R24	6-32	1-1/2	\$0.12
MS35206-238	-6R32	6-32	2	\$0.19
MS35206-241	-8R4	8-32	1/4	\$0.07
MS35206-242	-8R5	8-32	5/16	\$0.06
MS35206-243	-8R6	8-32	3/8	\$0.07
MS35206-244	-8R7	8-32	7/16	\$0.08
MS35206-245	-8R8	8-32	1/2	\$0.08
MS35206-246	-8R10	8-32	5/8	\$0.10
MS35206-247	-8R12	8-32	3/4	\$0.11
MS35206-248	-8R14	8-32	7/8	\$0.10
MS35206-249	-8R16	8-32	1	\$0.10
MS35206-250	-8R20	8-32	1-1/4	\$0.13
MS35206-251	-8R24	8-32	1-1/2	\$0.14
MS35206-252	-8R28	8-32	1-3/4	\$0.13
MS35206-253	-8R32	8-32	2	\$0.29
MS35206-261	-10R6	10-24	3/8	\$0.09
MS35206-262	-10R7	10-24	7/16	\$0.10
MS35206-263	-10R8	10-24	1/2	\$0.11
MS35206-264	-10R10	10-24	5/8	\$0.12
MS35206-265	-10R12	10-24	3/4	\$0.09
MS35206-267	-10R16	10-24	1	\$0.13

HA

MACHINE SCREWS

MS24693 & MS24693C MACHINE SCREWS

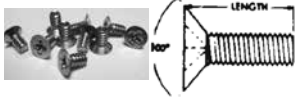

FORMERLY AN 507) - These non-structural screws have a 100° counter-sunk flat head. Cadmium plated, Type 2, Class 3. Tensile strength 55,000 PSI. For both CAD plated and Stainless MS24693C are stainless steel.

Thread	Length	MS24693 Cad Plated P/N	Price Each	MS24693C Stainless P/N	Price Each
4-40	3/8	MS24693S4	\$0.06	MS24693C4	\$0.06
	7/16	MS24693S5	\$0.05	---	---
	1/2	MS24693S6	\$0.07	MS24693C6	\$0.06
	5/8	MS24693S7	---	MS24693C7	\$0.09
	1	MS24693S10	\$0.11	MS24693C10	\$0.08
6-32	1/4	MS24693S24	\$0.06	MS24693C24	\$0.06
	3/8	MS24693S26	\$0.07	MS24693C26	\$0.08
	7/16	MS24693S27	---	MS24693C27	\$0.07
	1/2	MS24693S28	\$0.07	MS24693C28	\$0.10
	5/8	MS24693S29	\$0.07	MS24693C29	\$0.08
	3/4	MS24693S30	\$0.08	MS24693C30	\$0.11
	7/8	MS24693S31	\$0.09	---	---
8-32	1	MS24693S32	\$0.09	MS24693C32	\$0.11
	1-1/2	MS24693S36	\$0.17	---	---
	2	MS24693S40	\$0.21	---	---
	1/4	MS24693S46	\$0.08	MS24693C46	\$0.09
	3/8	MS24693S48	\$0.08	MS24693C48	\$0.11
	7/16	MS24693S49	---	MS24693C49	\$0.09
	1/2	MS24693S50	\$0.10	MS24693C50	\$0.12
	5/8	MS24693S51	\$0.10	MS24693C51	\$0.12
	3/4	MS24693S52	\$0.09	MS24693C52	\$0.14
	7/8	MS24693S53	\$0.11	---	---
	1	MS24693S54	\$0.12	MS24693C54	\$0.13
10-32	1-1/4	MS24693S56	---	MS24693C56	\$0.17
	1-1/2	MS24693S58	\$0.15	---	---
	2	MS24693S62	\$0.35	---	---
	1/4	MS24693S268	\$0.11	MS24693C268	\$0.14
	3/8	MS24693S270	\$0.08	MS24693C270	\$0.09
	7/16	MS24693S271	---	MS24693C271	\$0.14
	1/2	MS24693S272	\$0.09	MS24693C272	\$0.15
	5/8	MS24693S273	\$0.12	MS24693C273	\$0.17
	3/4	MS24693S274	\$0.11	MS24693C274	\$0.19
	1	MS24693S276	\$0.14	MS24693C276	\$0.21
1/4-28	1-1/4	MS24693S278	---	MS24693C278	\$0.22
	1-1/2	MS24693S280	\$0.16	---	---
	2	MS24693S284	\$0.44	---	---
	2-1/2	MS24693-S286	\$0.60	---	---
	7/16	---	---	MS24693C293	\$0.26
1/2	MS24693S294	---	MS24693C294	\$0.27	
5/8	MS24693S295	---	MS24693C295	\$0.42	
3/4	MS24693S296	\$0.16	---	---	
1	---	---	MS24693C298	\$0.39	

AN525 WASHER HEAD SCREWS



High-strength machine screws fabricated from alloy steel per specification AMS6300. Tensile strength 125,000 PSI. Cadmium plated per QQ-P-416, Type II, Class 3. Cross-recessed head.

Dash No.	Length in.	Grip in.	Thread Size	Price
AN525-832R4	1/4	1/32	8-32	\$0.19
AN525-832R5	5/16	--	8-32	\$0.13
AN525-832R6	3/8	1/32	8-32	\$0.13
AN525-832R7	7/16	1/16	8-32	\$0.15
AN525-832R8	1/2	1/8	8-32	\$0.14
AN525-832R9	9/16	5/32	8-32	\$0.17
AN525-832R10	5/8	7/32	8-32	\$0.16
AN525-832R11	11/16	9/32	8-32	\$0.18
AN525-832R12	3/4	11/32	8-32	\$0.17
AN525-832R14	7/8	15/32	8-32	\$0.20
AN525-832R16	1	19/32	8-32	\$0.17
AN525-832R18	1-1/8	23/32	8-32	\$0.26
AN525-832R20	1-1/4	27/32	8-32	\$0.24
AN525-832R22	1-3/8	31/32	8-32	\$0.52
AN525-832R24	1-1/2	1-3/32	8-32	\$0.35
AN525-8R9	9/16	5/32	8/36	\$0.17
AN525-10R4	1/4	--	10-32	\$0.12
AN525-10R5	5/16	--	10-32	\$0.16
AN525-10R6	3/8	1/32	10-32	\$0.14
AN525-10R7	7/16	1/16	10-32	\$0.15
AN525-10R8	1/2	1/8	10-32	\$0.16
AN525-10R9	9/16	5/32	10-32	\$0.17
AN525-10-9 (Slotted)	9/16	5/32	10-32	\$0.17
AN525-10R10	5/8	7/32	10-32	\$0.16
AN525-10R11	11/16	9/32	10-32	\$0.16
AN525-10R12	3/4	11/32	10-32	\$0.15
AN525-10R14	7/8	15/32	10-32	\$0.23
AN525-10R16	1	19/32	10-32	\$0.22
AN525-10R18	1-1/8	23/32	10-32	\$0.34
AN525-10R20	1-1/4	27/32	10-32	\$0.30
AN525-10R22	1-3/8	31/32	10-32	\$0.28
AN525-10R24	1-1/2	1-3/32	10-32	\$0.29
AN525-416R6	3/8	1/32	1/4-28	\$0.58
AN525-416R7	7/16	1/16	1/4-28	\$0.52
AN525-416R8	1/2	1/8	1/4-28	\$0.54
AN525-416R9	9/16	5/32	1/4-28	\$0.54
AN525-416R10	5/8	7/32	1/4-28	\$0.49
AN525-416R12	3/4	11/32	1/4-28	\$0.56
AN525-416R14	7/8	15/32	1/4-28	\$0.76
AN525-416R16	1	19/32	1/4-28	\$0.63
AN525-416R18	1-1/8	23/32	1/4-28	\$1.84
AN525-416R20	1-1/4	27/32	1/4-28	\$0.96

AN526 MACHINE SCREWS

Truss-head non-structural machine screws made of carbon steel, cadmium plated. Minimum tensile strength 55,000 PSI. Available in slot head or Phillips recessed head.

Thread	Length	Phillips Part No.	Price Ea.	Slotted Part No.	Price Ea.
4-40	1/4	AN526-440R4	\$0.20	----	---
	3/8	AN526-440R6	\$0.07	----	---
	1/2	AN526-440R8	\$0.06	----	---
	1	AN526-440R16	----	----	---
6-32	1/4	AN526-632R4	\$0.06	----	---
	5/16	AN526-632R5	\$0.06	----	---
	3/8	AN526-632R6	\$0.06	AN526-632-6	\$0.14
	7/16	AN526-632R7	\$0.06	----	---
	1/2	AN526-632R8	\$0.07	AN526-632-8	\$0.11
	9/16	AN526-632R9	\$0.08	----	---
8-32	5/8	AN526-632R10	\$0.07	AN526-632-10	\$0.54
	3/4	AN526-632R12	\$0.11	AN526-632-12	\$0.16
	7/8	AN526-632R14	\$0.09	----	---
	1	AN526-632R16	\$0.09	----	---
	1-1/2	AN526-632-R24	\$0.17	----	---
	2	AN526-632R32	\$0.20	----	---
	1/4	AN526-832R4	\$0.08	----	---
	5/16	AN526-832R5	\$0.10	----	---
	3/8	AN526-832R6	\$0.09	----	---
	7/16	AN526-832R7	\$0.08	----	---
10-32	1/2	AN526-832R8	\$0.09	AN526-832-8	\$0.46
	9/16	AN526-832R9	\$0.09	----	---
	5/8	AN526-832R10	\$0.09	----	---
	3/4	AN526-832R12	\$0.12	AN526-832-12	\$0.24
	7/8	AN526-832R14	\$0.12	----	---
	1	AN526-832R16	\$0.11	AN526-832-16	\$0.19
	1-1/4	AN526-832-R20	\$0.19	----	---
	1-1/2	AN526-832-R24	\$0.29	----	---
	1/4	AN526-1032R4	\$0.11	----	---
	5/16	AN526-1032R5	\$0.08	----	---
	3/8	AN526-1032R6	\$0.10	----	---
	7/16	AN526-1032R7	\$0.09	----	---
10-32	1/2	AN526-1032R8	\$0.11	----	---
	9/16	AN526-1032R9	\$0.10	----	---
	5/8	AN526-1032R10	\$0.11	AN526-1032-10	\$0.26
	3/4	AN526-1032R12	\$0.13	AN526-1032-12	\$0.13
	7/8	AN526-1032R14	\$0.12	AN526-1032-14	---
	1	AN526-1032R16	\$0.16	----	---
	1-1/8	AN526-1032R18	\$0.13	----	---
	1-1/4	AN526-1032R20	\$0.16	----	---
	1-1/2	AN526-1032R24	\$0.29	----	---
	1-3/4	AN526-1032R28	\$0.28	----	---
2	AN526-1032R32	\$0.52	----	---	

AN526C STAINLESS STEEL MACHINE SCREWS

Stainless steel Phillips and slotted, Use slotted screws for antiques.

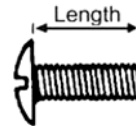

Thread	Length	Phillips Part No.	Price Ea.	Slotted Part No.	Price Ea.
4-40	1/2	AN526C-440R8	\$0.08	----	---
	1/4	AN526C-632R4	\$0.08	AN526C-632-4	\$0.33
	3/8	AN526C-632R6	\$0.10	----	---
6-32	1/2	AN526C-632R8	\$0.09	AN526C-632-8	\$0.20
	5/8	AN526C-632R10	\$0.11	AN526C-632-10	\$0.30
	3/4	AN526C-632R12	\$0.10	----	---
	1	AN526C-632R16	\$0.13	AN526C-632-16	\$0.29
8-32	1/4	AN526C-832R4	\$0.14	----	---
	3/8	AN526C-832R6	\$0.11	----	---
	1/2	AN526C-832R8	\$0.12	AN526C-832-8	\$0.20
	5/8	AN526C-832R10	\$0.13	AN526C-832-10	\$0.30
10-32	3/4	AN526C-832R12	\$0.14	AN526C-832-12	\$0.34
	1	AN526C-832R16	\$0.16	AN526C-832-16	\$1.50
	1/4	AN526C-1032R4	\$0.38	----	---
	3/8	AN526C-1032R6	\$0.14	AN526C-1032-6	\$0.28
	1/2	AN526C-1032R8	\$0.14	AN526C-1032-8	\$0.24
10-32	5/8	AN526C-1032R10	\$0.18	AN526C-1032-10	\$0.20
	3/4	AN526C-1032R12	\$0.19	AN526C-1032-12	---
	1	AN526C-1032R16	\$0.21	----	---
	1-1/4	AN526C-1032R20	----	----	---
1/4-20	1-1/2	AN526C-1032R24	\$0.28	----	---
	1/2	AN526C-420R8	\$1.57	----	---
1/4-28	1/2	AN526C-428R8	\$0.37	----	---
	3/4	AN526C-428R12	\$0.42	----	---
1-1/8	----	----	---	AN526C-428-18	\$0.69

Note: Some sizes of AN526C screws are furnished as commercial equipment as AN screws are no longer available.

HA

MACHINE SCREWS



MS24694 MACHINE SCREWS (FORMERLY AN509)

These structural screws have a 100° countersunk head. Cadmium plated per QQ-P-416, Type II, Class 3. Minimum tensile strength for steel is 125,000 PSI.

MS24694 Dash No.	AN509 Dash No.	Length In.	Grip In.	Thread Size	Price Each	MS24694 Dash No.	AN509 Dash No.	Length In.	Grip In.	Thread Size	Price Each
-S1	-8R4	9/32	3/32	8-32	\$0.10	-S65	-10R23	1-15/32	1	10-32	\$0.33
-S2	-8R5	11/32		8-32	\$0.13	-S66	-10R24	1-17/32	1-1/16	10-32	\$0.26
-S3	-8R6	13/32		8-32	\$0.12	-S67	-10R25	1-19/32	1-1/8	10-32	---
-S4	-8R7	15/32		8-32	\$0.12	-S68	-10R26	1-21/32	1-3/16	10-32	---
-S5	-8R8	17/32		8-32	\$0.12	-S69	-10R27	1-23/32	1-1/4	10-32	---
-S7	-8R10	21/32	7/32	8-32	\$0.19	-S70	-10R28	1-25/32	1-5/16	10-32	\$0.41
-S8	-8R11	23/32	9/32	8-23	---	-S71	-10R29	1-27/32	1-3/8	10-32	---
-S9	-8R12	25/32	11/32	8-32	\$0.14	-S72	-10R30	1-29/32	1-7/16	10-32	\$0.58
-S10	-8R13	27/32	13/32	8-32	---	-S74	-10R32	2-1/32	1-9/16	10-32	\$0.48
-S11	-8R14	29/32	15/32	8-32	\$0.18	-S75	-10R33	2-3/32	1-5/8	10-32	\$1.12
-S12	-8R15	31/32	17/32	8-32	---	-S76	-10R34	2-5/32	1-11/16	10-32	\$0.74
-S13	-8R16	1-1/32	19/32	8-32	\$0.18	-S77	-10R35	2-7/32	1-3/4	10-32	\$0.94
-S14	-8R17	1-1/32	21/32	8-32	---	-S79	-10R37	2-11/32	1-7/8	10-32	\$0.72
-S15	-8R18	1-5/32	23/32	8-32	\$0.21	-S82	-10R40	2-17/32	2-1/16	10-32	\$0.84
-S16	-8R19	1-7/32	25/32	8-32	---	-S84	-10R42	2-21/32	2-3/16	10-32	\$0.75
-S17	-8R20	1-9/32	27/32	8-32	\$0.21	-S88	-10R46	2-29/32	2-7/16	10-32	\$2.48
-S18	-8R21	1-11/32	29/32	8-32	\$0.28	-S90	-10R48	3-1/32	2-9/16	10-32	\$0.59
-S19	-8R22	1-13/32	31/32	8-32	\$0.20	-S93	-416R6	13/32	9/64	1/4-28	---
-S20	-8R23	1-15/32	1-1/32	8-32	---	-S94	-416R7	15/32		1/4-28	---
-S21	-8R24	1-17/32	1-3/32	8-32	\$0.28	-S95	-416R8	17/32		1/4-28	---
-S28	-8R31	1-31/32	1-17/32	8-32	\$0.63	-S96	-416R9	19/32		1/4-28	---
-S29	-8R32	2-1/32	1-19/32	8-32	\$1.50	-S97	-416R10	21/32		1/4-28	\$0.29
-S31	-8R34	2-5/32	1-23/32	8-32	\$1.36	-S98	-416R11	23/32	3-16	1/4-28	---
-S46	-10R4	9/32	7/64	10-32	---	-S99	-416R12	25/32	1/4	1/4-28	\$0.22
-S47	-10R5	11/32		10-32	---	-S100	-416R13	27/32	5/16	1/4-28	\$0.26
-S48	-10R6	13/32		10-32	\$0.13	-S101	-416R14	29/32	3/8	1/4-28	\$0.29
-S49	-10R7	15/32		10-32	\$0.14	-S102	-416R15	31/32	7/16	1/4-28	\$0.35
-S50	-10R8	17/32		10-32	\$0.14	-S103	-416R16	1-1/32	1/2	1/4-28	\$0.46
-S51	-10R9	19/32	10-32	\$0.18	-S104	-416R17	1-3/32	9/16	1/4-28	\$0.64	
-S52	-10R10	21/32	3/16	10-32	\$0.14	-S105	-416R18	1-5/32	5/8	1/4-28	\$0.29
-S53	-10R11	23/32	1/4	10-32	\$0.16	-S106	-416R19	1-7/32	11/16	1/4-28	\$0.26
-S54	-10R12	25/32	5/16	10-32	\$0.15	-S107	-416R20	1-9/32	3/4	1/4-28	---
-S55	-10R13	27/32	3/8	10-32	\$0.16	-S108	-416R21	1-11/32	13/16	1/4-28	---
-S56	-10R14	29/32	7/16	10-32	\$0.16	-S109	-416R22	1-13/32	7/8	1/4-28	\$0.41
-S57	-10R15	31/32	1/2	10-32	---	-S110	-416R23	1-15/32	15/16	1/4-28	\$0.36
-S58	-10R16	1-1/32	9/16	10-32	\$0.23	-S111	-416R24	1-17/32	1	1/4-28	\$0.38
-S59	-10R17	1-3/32	5/8	10-32	\$0.19	-S113	-416R26	1-21/32	1-1/8	1/4-28	\$0.70
-S60	-10R18	1-5/32	11/16	10-32	\$0.18	-S115	-416R28	1-25/32	1-1/4	1/4-28	\$0.49
-S61	-10R19	1-7/32	3/4	10-32	---	-S119	-416R32	2-1/32	1-1/2	1/4-28	\$0.72
-S62	-10R20	1-9/32	13/16	10-32	\$0.26	-S121	-416R34	2-5/32	1-5/8	1/4-28	\$2.28
-S63	-10R21	1-11/32	7/8	10-32	---	-S123	-416R36	2-9/32	1-3/4	1/4-28	\$1.83
-S64	-10R22	1-13/32	15/16	10-32	\$0.21	-S148	-516R16	1-1/32	15/32	5/16-24	---
						-S178	-516R46	2-29/32	2-11/32	5/16-24	---

HA



MS24694C STAINLESS STEEL MACHINE SCREWS

Same style screws as MS24694, except stainless steel. Phillips head. (Formerly AN509C) Minimum tensile strength for stainless steel is 85,000 PSI.

MS Part No.	AN509C No.	Thread Size	Length Inches	Price ea.	MS Part No.	AN509C No.	Thread Size	Length Inches	Price ea.
MS24694C1	-8R4	8-32	9/32	\$0.17	MS24694C48	-10R6	10-32	13/32	\$0.17
MS24694C2	-8R5	8-32	11/32	\$0.12	MS24694C49	-10R7	10-32	15/32	\$0.16
MS24694C3	-8R6	8-32	13/32	\$0.17	MS24694C50	-10R8	10-32	17/32	\$0.20
MS24694C4	-8R7	8-32	15/32	\$0.14	MS24694C51	-10R9	10-32	19/32	\$0.17
MS24694C5	-8R8	8-32	17/32	\$0.14	MS24694C52	-10R10	10-32	21/32	\$0.18
MS24694C6	-8R9	8-32	19/32	\$0.14	MS24694C53	-10R11	10-32	23/32	\$0.22
MS24694C7	-8R10	8-32	21/32	\$0.17	MS24694C54	-10R12	10-32	25/32	\$0.23
MS24694C8	-8R11	8-32	23/32	\$0.19	MS24694C55	-10R13	10-32	27/32	\$0.23
MS24694C9	-8R12	8-32	25/32	\$0.17	MS24694C56	-10R14	10-32	29/32	\$0.24
MS24694C10	-8R13	8-32	27/32	\$0.17	MS24694C57	-10R15	10-32	31/32	\$0.32
MS24694C11	-8R14	8-32	29/32	\$0.29	MS24694C58	-10R16	10-32	1-1/32	\$0.32
MS24694C13	-8R16	8-32	1-1/32	\$0.32	MS24694C59	-10R17	10-32	1-3/32	\$0.36
MS24694C14	-8R17	8-32	1-3/32	\$0.59	MS24694C60	-10R18	10-32	1-5/32	\$0.39
MS24694C15	-8R18	8-32	1-5/32	\$1.78	MS24694C61	-10R19	10-32	1-7/32	\$0.39
MS24694C46	-10R4	10-32	9/32	\$0.17	MS24694C62	-10R20	10-32	1-9/32	\$0.34
MS24694C47	-10R5	10-32	11/32	\$0.14	MS24694C92		1/4-28	3/8	\$0.59



NAS387 SERIES MACHINE SCREWS

Type: NAS387. Material: Carbon Steel Type 1016 - 1024. Finish: Nickel Plate

Thread	Length	Part No.	Price	Thread	Length	Part No.	Price	
6-32	3/8	NAS387-632-6P	\$0.16	10-32	1/2	NAS387-1032-8P	\$0.30	
	7/16	NAS387-632-7P	---		5/8	NAS387-1032-10P	\$0.20	
	1/2	NAS387-632-8P	\$0.11		3/4	NAS387-1032-12P	\$0.26	
	5/8	NAS387-632-10P	\$0.16		7/8	NAS387-1032-14P	\$0.30	
	3/4	NAS387-632-12P	\$0.24		1	NAS387-1032-16P	\$0.30	
8-32	1/2	NAS387-832-8P	\$0.20		1-1/8	NAS387-1032-18P	---	
	5/8	NAS387-832-10P	\$0.20		1-1/4	NAS387-1032-20P	\$0.29	
	3/4	NAS387-832-12P	\$0.24		1/2	NAS387-1032-24P	\$0.46	
	7/8	NAS387-832-14P	\$0.32					

FILLISTER HEAD SCREWS - DRIVE SCREWS

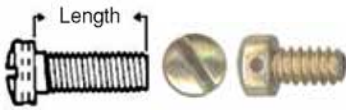

AN500, AN501 FILLISTER HEADSCREWS

AN500 (coarse thread) & AN501 (fine thread) slotted fillister head screws are fabricated from carbon steel. Tensile strength 60,000 PSI. Cadmium plated, Type II Class 3.
If there is an "A" after the dash, the part is cadmium plated, Type II, Class 3, with a drilled head. If there isn't an "A" after the dash, the part is Cadmium plated, Type I.

HA

AN500					
AN500 Dash No.*	MS35265 Dash No.	Length (In.)	Thread Size	Price ea. Drilled	Price ea. Undrilled
-A4-3	MS35265-12	3/16	4-40	\$0.20	---
-A4-4	MS35265-13	1/4	4-40	\$0.25	---
-A4-5	MS35265-14	5/16	4-40	\$0.27	---
-A4-6	MS35265-15	3/8	4-40	\$0.36	---
-A4-7	MS35265-16	7/16	4-40	\$0.23	---
-A4-8	MS35265-17	1/2	4-40	\$0.26	---
-A4-10	MS35265-18	5/8	4-40	\$0.24	---
-A4-12	MS35265-19	3/4	4-40	\$0.24	---
-A6-4	MS35265-26	1/4	6-32	\$0.43	\$0.38
-A6-5	MS35265-27	5/16	6-32	\$0.22	---
-A6-6	MS35265-28	3/8	6-32	\$0.19	\$0.38
-A6-7	MS35265-29	7/16	6-32	\$0.25	---
-A6-8	MS35265-30	1/2	6-32	\$0.20	---
-A6-10	MS35265-31	5/8	6-32	---	---
-A6-12	MS35265-32	3/4	6-32	\$0.27	---
-A6-14	MS35265-33	7/8	6-32	\$0.28	---
-A8-4	MS35265-41	1/4	8-32	\$0.31	---
-A8-5	MS35265-42	5/16	8-32	\$0.66	---
-A8-6	MS35265-43	3/8	8-32	\$0.21	---
-A8-7	MS35265-44	7/16	8-32	\$0.27	---
-A8-8	MS35265-45	1/2	8-32	\$0.24	\$0.78
-A8-10	MS35265-46	5/8	8-32	\$0.26	---
-A8-12	MS35265-47	3/4	8-32	\$0.25	---
-A8-14	MS35265-48	7/8	8-32	\$0.23	---
-A8-16	MS35265-49	1	8-32	\$0.60	---
-A10-4	MS35265-59	1/4	10-24	\$0.53	---
-A10-5	MS35265-60	5/16	10-24	\$0.83	---
-A10-6	MS35265-61	3/8	10-24	\$0.31	---
-A10-7	MS35265-62	7/16	10-24	\$0.27	---
-A10-8	MS35265-63	1/2	10-24	\$0.29	---
-A10-10	MS35265-64	5/8	10-24	\$0.27	---
-A10-12	MS35265-65	3/4	10-24	\$0.25	---
-A10-16	MS35265-66	1	10-24	\$0.64	---
-A416-8	MS35265-79	1/2	1/4-20	\$0.96	---
-A416-10	MS35265-80	5/8	1/4-20	\$0.69	---
-416-12	MS35265-81	3/4	1/4-20	\$0.42	---
AN501					
AN501 Dash No.*	MS35266 Dash No.	Length (In.)	Thread Size	Price ea. Drilled	Price ea. Undrilled
-8-12	-47	3/4	8-36	---	---
-A10-4	-59	1/4	10-32	\$0.40	---
-A10-6	-61	3/8	10-32	\$0.68	---
-A10-8	-63	1/2	10-32	\$0.28	---
-A10-10	-64	5/8	10-32	\$0.25	---
-A10-12	-65	3/4	10-32	\$0.25	---
-A10-14	-66	7/8	10-32	\$0.27	---
-A10-16	-67	1	10-32	\$0.29	---
-A10-20	-68	1-1/4	10-32	\$0.33	---

AN500AD Stainless Steel					
AN500 Dash No.*	MS35275 Dash No.	Length (In.)	Thread Size	Price ea. Drilled	Price ea. Undrilled
-AD2-2	-201	1/8	2/56	\$0.60	---
-AD2-3	-202	3/16	2/56	\$0.29	---
-AD2-4	-203	1/4	2/56	\$0.29	---
-AD2-5	-204	5/16	2/56	\$0.45	---
-AD2-6	-205	3/8	2/56	\$0.46	---
-AD2-7	-206	7/16	2/56	\$0.54	---
-AD2-8	-207	1/2	2/56	\$0.35	---
-AD2-10	-208	5/8	2/56	\$0.29	---
-AD2-12	-209	3/4	2/56	\$0.68	---
-AD4-2	-211	1/8	4-40	\$0.73	---
-AD4-3	-212	3/16	4-40	\$0.24	---
-AD4-4	-213	1/4	4-40	\$0.31	---
-AD4-6	-215	3/8	4-40	\$0.33	---
-AD4-7	-216	7/16	4-40	\$0.32	---
-AD4-8	-217	1/2	4-40	\$0.26	---
-AD4-10	-218	5/8	4-40	\$0.43	---
-AD4-12	-219	3/4	4-40	\$0.33	---
-AD4-14	-220	7/8	4-40	\$0.33	---
-AD4-16	-221	1	4-40	\$0.35	---
-AD6-4	-226	1/4	6-32	\$0.29	---
-AD6-5	-227	5/16	6-32	\$0.25	---
-AD6-6	-228	3/8	6-32	\$0.34	---
-AD6-7	-229	7/16	6-32	\$0.37	---
-AD6-8	-230	1/2	6-32	\$0.25	---
-AD6-10	-231	5/8	6-32	\$0.32	---
-AD6-12	-232	3/4	6-32	\$0.33	---
-AD6-14	-233	7/8	6-32	\$0.39	---
-AD6-16	-234	1	6-32	\$0.36	---
-AD8-5	-242	5/16	8-32	\$0.33	---
-AD8-6	-243	3/8	8-32	\$0.88	---
-AD8-7	-244	7/16	8-32	\$0.34	---
-AD8-8	-245	1/2	8-32	\$0.34	---
-AD8-10	-246	5/8	8-32	\$0.34	---
-AD8-12	-247	3/4	8-32	\$0.35	---
-AD8-14	-248	7/8	8-32	\$0.35	---
-AD8-16	-249	1	8-32	\$0.45	---
AN501AD Stainless Steel					
AN501 Dash No.*	MS35276 Dash No.	Length (In.)	Thread Size	Price ea. Drilled	Price ea. Undrilled
-AD10-5	-260	5/16	10-32	\$0.43	---
-AD10-6	-261	3/8	10-32	\$0.48	---
-AD10-7	-262	7/16	10-32	\$0.33	---
-AD10-8	-263	1/2	10-32	\$0.38	---
-AD10-10	-264	5/8	10-32	\$0.42	---
-AD10-12	-265	3/4	10-32	\$0.44	---
-AD10-14	-266	7/8	10-32	\$0.55	---
-AD10-16	-267	1	10-32	\$0.57	---

AN502, AN503 FILLISTER HEAD SCREWS



AN502 (fine thread) and AN503 (coarse thread) drilled head, slotted fillister head screws are fabricated from steel meeting specification MIL-S-6050. Tensile strength 125,000 PSI. Cadmium plated, Type I, Class 3.

AN502

AN502 Dash No.*	Length (In.)	Thread Size	Price Each
-10 -5	19/64	10-32	\$1.34
-10 -6	3/8	10-32	\$0.29
-10 -8	1/2	10-32	\$0.41
-10 -10	5/8	10-32	\$0.37
-10 -12	3/4	10-32	\$0.37
-10 -16	1	10-32	\$0.46
-416 -12	3/4	1/4-28	\$1.24
-416 -16	1	1/4-28	\$1.61

AN503

AN503 Dash No.*	Length (In.)	Thread Size	Price Each	AN503 Dash No.*	Length (In.)	Thread Size	Price Each
-6 -4	1/4	6-32	\$0.44	-10 -6	3/8	10-24	\$0.44
-6 -6	3/8	6-32	\$0.26	-10 -8	1/2	10-24	\$0.43
-8 -4	1/4	8-32	\$0.26	-10 -10	5/8	10-24	\$0.47
-8 -6	3/8	8-32	\$0.26	-10 -12	3/4	10-24	\$0.39
-8 -8	1/2	8-32	\$0.39	-10 -16	1	10-24	\$0.85
-8 -10	5/8	8-32	\$0.35	-10 -24	1-1/2	10-24	\$0.57
-8 -16	1	8-32	\$0.42	-416 -8	1/2	1/4-20	\$0.63
				-416 -10	5/8	1/4-20	\$0.77
				-416 -12	3/4	1/4-20	\$0.92

ALLOY/STRUCTURAL — MACHINE SCREWS



MS51957 / MS51958 STAINLESS MACHINE SCREWS

- Phillips Pan Head
- 300 Series Stainless Steel
- Finish - Passivate per QQ-P-35

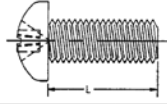

Thread	Length	Phillips Part No.	Price Each	Thread	Length	Phillips Part No.	Price Each
2-56	.188	MS51957-2	\$0.05	6-32	.500	MS51957-30	\$0.09
	.250	MS51957-3	\$0.06		.625	MS51957-31	\$0.11
	.312	MS51957-4	\$0.07		.750	MS51957-32	\$0.11
	.375	MS51957-5	\$0.06		.875	MS51957-33	\$0.10
	.438	MS51957-6	\$0.07		1.00	MS51957-34	\$0.11
	.500	MS51957-7	\$0.08		.250	MS51957-41	\$0.09
4-40	.750	MS51957-9	\$0.07	.312	MS51957-42	\$0.09	
	.875	MS51957-10	\$0.10	.375	MS51957-43	\$0.14	
	.188	MS51957-12	\$0.05	.438	MS51957-44	\$0.12	
	.250	MS51957-13	\$0.06	.500	MS51957-45	\$0.15	
	.312	MS51957-14	\$0.07	.625	MS51957-46	\$0.13	
	.375	MS51957-15	\$0.09	.750	MS51957-47	\$0.13	
	.438	MS51957-16	\$0.07	.875	MS51957-48	\$0.15	
	.500	MS51957-17	\$0.07	1.00	MS51957-49	\$0.14	
	.625	MS51957-18	\$0.08	.312	MS51958-60	\$0.12	
	.750	MS51957-19	\$0.08	.375	MS51958-61	\$0.14	
	.875	MS51957-20	\$0.11	.438	MS51958-62	\$0.16	
	1.00	MS51957-21	\$0.11	.500	MS51958-63	\$0.15	
6-32	.188	MS51957-25	\$0.09	.625	MS51958-64	\$0.17	
	.250	MS51957-26	\$0.08	.750	MS51958-65	\$0.21	
	.312	MS51957-27	\$0.12	.875	MS51958-66	\$0.21	
	.375	MS51957-28	\$0.08	1.00	MS51958-67	\$0.21	
	.438	MS51957-29	\$0.09	1.25	MS51958-68	\$0.28	

Fingertip Assembly



SNAP BUSHINGS

Ideal for abrasion and cutting protection of wiring, antenna leads, tubing, cables, etc. that are routed through bulkheads, ribs and other internal aircraft structures. Made of hard black nylon. Drill a hole about 1/8" larger than bushing I.D. and insert bushing. Spring-like fingers snap out to hold it in place. Special sizes on request with 100 piece minimum. *For .062" max. bulkhead thickness. All others for .125" max. bulkhead thickness.

Mounting Part No.	Hole Dia.	Bushing I.D.	Price Each	Mounting Part No.	Hole Dia.	Bushing I.D.	Price Each
04-05700*	.250	1/8"	\$0.10	04-05753	.500	3/8"	\$0.15
04-05710*	.312	3/16"	\$0.25	04-05775	.625	1/4"	\$0.35
04-05730	.375	1/4"	\$0.12	04-05773	.625	1/2"	\$0.18
04-05738	.437	1/4"	\$0.19	04-05790	.750	3/8"	\$0.38
04-05758	.500	1/4"	\$0.18	04-05793	.750	9/16"	\$0.20

*For .062" max. bulkhead thickness. All others for .125" max. bulkhead thickness. Less 15% Discount on 100 pieces per size.

SNAP BUSHINGS



Converts raw-edged holes to smooth, neat, insulated holes. Locking fingers "snap" into holes with fingertip pressure. Locking finger steps are designed at fractional increments to accommodate a range of panel thicknesses up to .250" (6.4 mm). Withstands a push back force of 35 pounds.

Panel Dimensions		P/N	Part Dimensions								
Maximum Thickness	Mounting Hole Dia.	Color	UL/CSA Designation	A Inside Diameter	B Head Diameter	C Overall Height					
in.	mm.	in.	mm.	in.	mm.	in.	mm.				
.125	3,2	1.093 - 1.125	8-28, 6	2163	SB1093 - 14	.875	22,2	1.218	30,9	.453	11,5
.125	3,2	1.093 - 1.125	8-28, 6	2166	SB1093 - 15	.937	23,8	1.218	30,9	.453	11,5

Model 2163.....P/N 04-01985.....\$0.25
 Model 2166.....P/N 04-01986.....\$0.35

AN535 DRIVE SCREWS



Hardened steel screws to make permanent fastenings to ferrous and non-ferrous castings, heavy gauge steel, plastics, etc. Cadmium plated. Spec. MS21318

AN535 Dash #	MS21318 Dash #	Dia. In.	Length In.	Sugg. Drill Size	Price Each
-00-4	-3	.060	1/4	#55 (.052")	\$0.78
-0-4	-9	.075	1/4	#51 (.067")	\$0.06
-2-3	-14	.100	3/16	#44 (.086")	\$0.06
-2-4	-15	.100	1/4	#44 (.086")	\$0.06
-4-4	-21	.116	1/4	#37 (.104")	\$0.08
-00-2	-1	.060	1/8	#55 (.052")	\$0.05
-00-3	-2	.060	3/16	#55 (.052")	\$0.06
-0-2	-7	.075	1/8	#51 (.067")	\$0.06
-0-3	-8	.075	3/16	#51 (.067")	\$0.06
-2-2	-13	.100	1/8	#44 (.086")	\$0.06
-4-3	-20	.116	3/16	#37 (.104")	\$0.08
-4-5	-22	.116	5/16	#37 (.104")	\$0.07

NAS514 MACHINE SCREWS

- Phillips 100° Flat Head
- Fully Threaded
- Alloy Steel (8740)
- Finish - Cadmium per QQ-P-416 Type II
- Tensile - 125,000 145,000 PSI

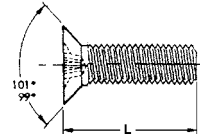

Thread	Length	Phillips Part No.	Price Ea.	
4-40	.250	NAS514P440-4P	\$0.10	
	.312	NAS514P440-5P	\$0.08	
	.375	NAS514P440-6P	\$0.08	
	.438	NAS514P440-7P	\$0.14	
	.500	NAS514P440-8P	\$0.08	
	.625	NAS514P440-10P	\$0.08	
6-32	.750	NAS514P440-12P	\$0.16	
	.188	NAS514P632-3P	\$0.36	
	.250	NAS514P632-4P	\$0.13	
	.312	NAS514P632-5P	\$0.12	
	.375	NAS514P632-6P	\$0.11	
	.438	NAS514P632-7P	\$0.12	
	.500	NAS514P632-8P	\$0.13	
	.625	NAS514P632-10P	\$0.12	
	.750	NAS514P632-12P	\$0.36	
	.875	NAS514P632-14P	\$0.13	
	1.00	NAS514P632-16P	\$0.09	
	8-32	.250	NAS514P832-4P	\$0.14
.312		NAS514P832-5P	\$0.13	
.375		NAS514P832-6P	\$0.13	
.438		NAS514P832-7P	\$0.14	
.500		NAS514P832-8P	\$0.14	
.625		NAS514P832-10P	\$0.16	
.750		NAS514P832-12P	\$0.12	
.875		NAS514P832-14P	\$0.20	
1.00		NAS514P832-16P	\$0.28	
1.25		NAS514P832-20P	\$0.19	
10-32		.250	NAS514P1032-4P	\$0.13
		.312	NAS514P1032-5P	\$0.14
	.375	NAS514P1032-6P	\$0.13	
	.438	NAS514P1032-7P	\$0.16	
	.500	NAS514P1032-8P	\$0.20	
	.625	NAS514P1032-10P	\$0.18	
	.750	NAS514P1032-12P	\$0.30	
	.875	NAS514P1032-14P	\$0.19	
	1.00	NAS514P1032-16P	\$0.20	
	1.25	NAS514P1032-20P	\$0.28	

NAS517 FLUSH HEAD SCREWS

- Phillips 100 Deg. Flat Head
- Alloy Steel Per Mil-S-6049
- Finish - Cad Plate per QQ-P-416 Type II

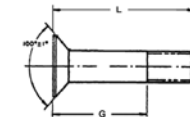

Thread	Grip	Length	Phillips Part No.	Price Ea.
8-32	.469		NAS517-2-1	\$0.27
	.531		NAS517-2-2	\$0.18
	.594		NAS517-2-3	\$0.19
	.656		NAS517-2-4	\$0.14
	.719		NAS517-2-5	\$0.17
	.781		NAS517-2-6	\$0.19
	.844		NAS517-2-7	\$0.17
	.906		NAS517-2-8	\$0.18
	.969		NAS517-2-9	\$0.13
	1.031		NAS517-2-10	\$0.44
	1.093		NAS517-2-11	\$0.84
	1.156		NAS517-2-12	\$0.20
10-32	.406		NAS517-3-0	\$0.18
	.469		NAS517-3-1	\$0.14
	.531		NAS517-3-2	\$0.16
	.594		NAS517-3-3	\$0.13
	.656		NAS517-3-4	\$0.14
	.719		NAS517-3-5	\$0.14
	.781		NAS517-3-6	\$0.16
	.844		NAS517-3-7	\$0.17
	.906		NAS517-3-8	\$0.19
	.969		NAS517-3-9	\$0.20
	1.031		NAS517-3-10	\$0.19
	1.093		NAS517-3-11	\$0.18
1.156		NAS517-3-12	\$0.17	
.812		NAS517-3-13	\$0.17	
.875		NAS517-3-14	\$0.19	
1.00		NAS517-3-16	\$0.19	

SET SCREWS

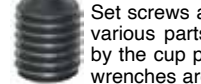

Set screws are used to provide immediate, binding location of various parts on shafts. Maximum holding pressure is made by the cup point edge gripping the contact surface. Allen head wrenches are used to operate set screws.

Part No.	Thread	Length	Price	Part No.	Thread	Length	Price
04-00182	8-32	3/16	\$0.09	04-00189	10-32	1/2	\$0.23
04-00183	8-32	1/4	\$0.14	04-00191	1/4-28	5/16	\$0.12
04-00184	10-32	1/4	\$0.20				

10-32 X 1/4 INCH ALLEN SET SCREW



Set Screw - Socket Products Type: Socket Set Screws Point Type: Cup Thread Size: 10-32 Overall Length: 1/4 Material: Alloy Steel - Grade 8 Finish/Coating: Black Oxide. Key Size (Inch): 3/32. Metalworking Book: 2085. Big Book: 1830P/N 04-01032\$0.54

SHORTY BUSHING 2820



Material: 6/6 Nylon Certifications: File E15331 File LR8919 Flammability Rating: 94V-2 Material Temperature Index: 125°C (257°F)—Max. temperature on part not to exceed 105°C (221°F) Insulating feed-thru bushings for limited internal clearance applicationsP/N 04-02026\$0.15

ALLOY/STRUCTURAL – MACHINE SCREWS

NAS600 - NAS603 MACHINE SCREWS



Thread	Length	Part No.	Price Ea.
4-40	.188	NAS600-3P	\$0.22
	.250	NAS600-4P	\$0.08
	.312	NAS600-5P	\$0.09
	.375	NAS600-6P	\$0.09
	.438	NAS600-7P	\$0.11
6-32	.500	NAS600-8P	\$0.07
	.188	NAS601-3P	\$0.12
	.250	NAS601-4P	\$0.08
	.312	NAS601-5P	\$0.13
	.375	NAS601-6P	\$0.09
	.438	NAS601-7P	\$0.10
	.500	NAS601-8P	\$0.12
	.562	NAS601-9P	\$0.27
	.625	NAS601-10P	\$0.14
	.750	NAS601-12P	\$0.14
8-32	.188	NAS602-3P	\$0.15
	.250	NAS602-4P	\$0.11
	.312	NAS602-5P	\$0.13
	.375	NAS602-6P	\$0.14
	.438	NAS602-7P	\$0.14
	.500	NAS602-8P	\$0.16
	.562	NAS602-9P	\$0.14
	.625	NAS602-10P	\$0.14
	.688	NAS602-11P	\$0.13
	.750	NAS602-12P	\$0.18
	.813	NAS602-13P	\$0.14
	.875	NAS602-14P	\$0.32
	1.00	NAS602-16P	\$0.15
	10-32	.250	NAS603-4P
.312		NAS603-5P	\$0.14
.375		NAS603-6P	\$0.14
.438		NAS603-7P	\$0.18
.500		NAS603-8P	\$0.20
.562		NAS603-9P	\$0.21
.625		NAS603-10P	\$0.21
.688		NAS603-11P	\$0.19
.750		NAS603-12P	\$0.23
.813		NAS603-13P	\$0.17
.875	NAS603-14P	\$0.28	
.938	NAS603-15P	\$0.16	
1.00	NAS603-16P	\$0.25	
1.125	NAS603-18P	\$0.23	
1.25	NAS603-20P	\$0.39	

- Phillips Pan Head
- Alloy Steel (8740)
- Finish - Cadmium per QQ-P-416
- Tensile -160,000 - 180,000 PSI

NAS1202 / NAS1203 FLUSH HEAD SCREWS

- Phillips 100° Flat Head
- Tensile – 160,000 – 180,000 PSI
- Alloy Steel Per MIL-S-6049
- Finish - Cadmium per QQ-P-416, Type II



Thread	Grip	Length	Part No.	Price Ea.
8-32	.125	.401	NAS1202-2	\$0.16
	.188	.464	NAS1202-3	\$0.24
	.250	.526	NAS1202-4	\$0.13
	.312	.588	NAS1202-5	\$0.44
	.375	.651	NAS1202-6	\$0.17
10-32	.125	.401	NAS1203-2	\$0.23
	.188	.464	NAS1203-3	\$0.18
	.250	.526	NAS1203-4	\$0.49
	.312	.588	NAS1203-5	\$0.17
	.375	.651	NAS1203-6	\$0.18
	.438	.714	NAS1203-7	\$0.22
	.500	.776	NAS1203-8	\$0.18

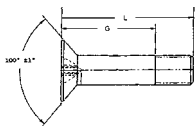

MS51959 MACHINE SCREWS

- Phillips 82° Flat Head
- Stainless Steel

Thread	Length	Part No.	Each	Thread	Length	Part No.	Each
2-56	.188	MS51959-2	\$0.05	6-32	.312	MS51959-27	\$0.09
	.250	MS51959-3	\$0.06		.375	MS51959-28	\$0.08
	.312	MS51959-4	\$0.05		.438	MS51959-29	\$0.09
	.375	MS51959-5	\$0.07		.500	MS51959-30	\$0.10
	.250	MS51959-13	\$0.06		.625	MS51959-31	\$0.09
4-40	.312	MS51959-14	\$0.07	8-32	.375	MS51959-43	\$0.09
	.375	MS51959-15	\$0.07		.438	MS51959-44	\$0.12
	.438	MS51959-16	\$0.07		.500	MS51959-45	\$0.12
	.500	MS51959-17	\$0.08		.625	MS51959-46	\$0.12
					.750	MS51959-47	\$0.11

NAS1096 HEX HEAD SCREWS

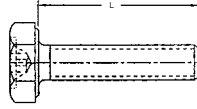

- Phillips Hex Head
- Alloy Steel per MIL-S-6049
- Finish - Cadmium per QQ-P-416 Type II
- Tensile – 125,000-145,000 PSI

Thread	Length	Part No.	Price Ea.
6-32	.375	NAS1096-1-6	\$0.14
	.438	NAS1096-1-7	\$0.34
	.500	NAS1096-1-8	\$0.19
	.562	NAS1096-1-9	\$0.16
	.625	NAS1096-1-10	\$0.25
	.750	NAS1096-1-12	\$0.18
8-32	.312	NAS1096-2-5	\$0.10
	.375	NAS1096-2-6	\$0.19
	.438	NAS1096-2-7	\$0.13
	.500	NAS1096-2-8	\$0.14
	.562	NAS1096-2-9	\$0.18
	.625	NAS1096-2-10	\$0.32
10-32	.750	NAS1096-2-12	\$0.17
	.312	NAS1096-3-5	\$0.12
	.375	NAS1096-3-6	\$0.18
	.438	NAS1096-3-7	\$0.18
	.500	NAS1096-3-8	\$0.17
	.562	NAS1096-3-9	\$0.16
	.625	NAS1096-3-10	\$0.18
	.750	NAS1096-3-12	\$0.23
	.875	NAS1096-3-14	\$0.26
	1.00	NAS1096-3-16	\$0.28
1.25	NAS1096-3-20	\$0.38	

NAS1801 HEX HEAD SCREWS

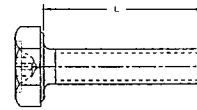

- Phillips Hex Head
- Alloy Steel Per MIL-S-6049
- Finish - Cad Plate per QQ-P-416, Type II
- Tensile – 160,000-185,000 PSI

Thread	Length	Part No.	Price Ea.
8-32	.250	NAS1801-08-4	\$0.19
	.312	NAS1801-08-5	\$0.17
	.375	NAS1801-08-6	\$0.16
	.438	NAS1801-08-7	\$0.14
	.500	NAS1801-08-8	\$0.19
	.562	NAS1801-08-9	\$0.33
	.625	NAS1801-08-10	\$0.18
	.750	NAS1801-08-12	\$0.33
	.875	NAS1801-08-14	\$0.25
	1.00	NAS1801-08-16	\$0.21
	1.125	NAS1801-08-18	\$0.52
	1.25	NAS1801-08-20	\$0.47
	1.375	NAS1801-08-22	\$0.65
	10-32	.312	NAS1801-3-5
.375		NAS1801-3-6	\$0.19
.438		NAS1801-3-7	\$0.19
.500		NAS1801-3-8	\$0.21
.562		NAS1801-3-9	\$0.35
.625		NAS1801-3-10	\$0.34
.750		NAS1801-3-12	\$0.26
.875		NAS1801-3-14	\$0.24
1.00		NAS1801-3-16	\$0.34
1.125		NAS1801-3-18	\$0.36
1.25	NAS1801-3-20	\$0.35	
1.375	NAS1801-3-22	\$0.48	
1.50	NAS1801-3-24	\$0.51	

NAS623 PAN HEAD SCREWS



- Phillips Pan Head
- Alloy Steel per MIL-S-6049
- Finish: Cadmium per QQ-P-416, Type II
- Tensile: 160,000-180,000 PSI

Thread	Length	Part No.	Each	Thread	Length	Part No.	Each
8-32	.338	NAS623-2-1	\$0.14	10-32	.588	NAS623-3-5	\$0.17
	.401	NAS623-2-2	\$0.15		.651	NAS623-3-6	\$0.18
	.464	NAS623-2-3	\$0.16		.714	NAS623-3-7	\$0.22
	.526	NAS623-2-4	\$0.19		.776	NAS623-3-8	\$0.33
	.588	NAS623-2-5	\$0.49		.838	NAS623-3-9	\$0.22
	.651	NAS623-2-6	\$0.21		.901	NAS623-3-10	\$0.17
	.714	NAS623-2-7	\$0.19		.964	NAS623-3-11	\$0.19
	.776	NAS623-2-8	\$0.21		1.026	NAS623-3-12	\$0.21
	.838	NAS623-2-9	\$0.20		1.088	NAS623-3-13	\$0.27
	.901	NAS623-2-10	\$0.17		1.151	NAS623-3-14	\$0.21
.964	NAS623-2-11	\$0.21	1.214	NAS623-3-15	\$0.24		
1.026	NAS623-2-12	\$0.20	1.276	NAS623-3-16	\$0.21		
.401	NAS623-3-2	\$0.18	1.338	NAS623-3-17	\$0.54		
.464	NAS623-3-3	\$0.18	1.401	NAS623-3-18	\$0.32		
.526	NAS623-3-4	\$0.35					

SHEET METAL SCREWS

TRUSS HEAD TYPE A STAINLESS



Size	Length	Phillips		Slotted	
		Part No.	Price Each	Part No.	Price Each
4	1/4	T4X4	\$0.06	TS4X4	\$0.04
	3/8	T4X6	\$0.04	TS4X6	\$0.13
	1/2	T4X8	\$0.04	TS4X8	\$0.08
6	1/4	T6X4	\$0.05	TS6X4	---
	3/8	T6X6	\$0.06	TS6X6	\$0.07
	1/2	T6X8	\$0.07	TS6X8	\$0.08
	5/8	T6X10	\$0.05	TS6X10	\$0.06
	3/4	T6X12	\$0.07	TS6X12	\$0.07
	1	T6X16	\$0.06	TS6X16	---
8	3/8	T8X6	\$0.07	TS8X6	---
	1/2	T8X8	\$0.07	TS8X8	\$0.23
	5/8	T8X10	\$0.08	TS8X10	\$0.07
	3/4	T8X12	\$0.07	TS8X12	\$0.53
	1	T8X16	\$0.10	TS8X16	\$0.17
	1-1/4	T8X20	\$0.14	TS8X20	\$0.08
10	3/8	T10X6	\$0.09	TS10X6	---
	1/2	T10X8	\$0.09	TS10X8	\$0.09
	5/8	T10X10	\$0.10	TS10X10	\$0.22
	3/4	T10X12	\$0.10	TS10X12	\$0.15
	1	T10X16	\$0.15	TS10X16	\$0.09
	1-1/4	T10X20	\$0.17	TS10X20	\$0.10

TRUSS HEAD TYPE B PHILLIPS STAINLESS



Size	Head Size	L (in)	P/N	Price	Size	Head Size	L (in)	P/N	Price	
4	1/4"	3/8	04-00164	\$0.11	8	3/8"	3/8	04-00174	\$0.13	
		1/2	04-00166	\$0.10			1/2	T8X8B	\$0.11	
		1/2	04-00167	\$0.17			5/8	04-00007	\$0.15	
6	5/16"	1/4	04-00168	\$0.05	3/4	04-00176	\$0.18	1	04-00177	\$0.52
		3/8	04-00169	\$0.09	3/8	04-00178	\$0.12			
		1/2	T6X8B	\$0.12	1/2	T10X8B	\$0.17			
		5/8	04-00171	\$0.29	5/8	04-00008	\$0.17			
		3/4	04-00172	\$0.17	3/4	04-00179	\$0.16			
		1	04-00173	\$0.32	1	04-00181	\$0.25			

82° OVAL HEAD TYPE A, PHILLIPS (FOR UPHOLSTERY)



Size	Length	Stainless P/N	Price Ea	Zinc P/N	Price Ea
4	1/4	O4X4	\$0.05	O4X4Z	---
	3/8	O4x6	\$0.05	O4X6Z	\$0.09
	1/2	O4X8	\$0.04	O4X8Z	---
	5/8	O4X10	\$0.04	O4X10Z	---
	1/2	O6X8	\$0.04	O6X8Z	\$0.04
	5/8	O6X10	\$0.04	O6X10Z	---
8	3/4	O6X12	\$0.05	O6X12Z	---
	1	O6X16	\$0.07	O6X16Z	---
	3/8	O8X6	\$0.08	O8X6Z	---
	3/4	O8X12	\$0.10	O8X12Z	---
10	1	O8X16	\$0.07	O8X16Z	---
	1/2	O10X8	\$0.10	O10X8Z	---
	3/4	O10X12	\$0.10	O10X12Z	---

100° FLAT HEAD TYPE A, PHILLIPS, STAINLESS



Size	Length	Part No.	Price
6	1/2	6RX1/2-A-FL-SS	\$0.12
8	1/2	C8X8	\$0.09
10	1/2	10RX1/2-A-FL-SS	\$0.14
10	5/8	10RX5/8-A-FL-SS	\$0.19

AN530 ROUND HEAD Use slotted type for antiques.



Size	Slotted		Phillips	
	Price	P/N AN530 Dash#	Price	P/N AN530 Dash#
4X1/4	---	---	\$0.08	4R4
4X3/8	\$0.24	-4-6	---	N/A
4X1/2	---	---	\$0.36	4R8
6X3/8	---	-6-6	\$0.10	6R6
6X1/2	---	-6-8	\$0.09	6R8
6X5/8	---	---	\$0.84	6R10
6X3/4	---	-6-12	---	6R12
8X3/8	---	---	\$0.10	8R6
8X1/2	---	---	\$0.14	8R8
10X1/2	---	10-8	\$0.22	10R8

FLAT HEAD TYPE B, PHILLIPS, STAINLESS



Size	Length	Degree	Part No.	Price Ea
6	3/8	100°	MS21207-C6-6	\$0.09
6	1/2	100°	MS21207-C6-8	\$0.12
8	1/2	100°	MS21207-C8-8	\$0.12
8	5/8	100°	MS21207-C8-10	\$0.13
10	1/2	100°	MS21207-C10-8	\$0.17
8	1/2	82°	04-00187	\$0.10

ZINC-PLATED, TRUSS HEAD TYPE A & TYPE B



Size	Length	Phillips			Slotted		
		Part No. Type A	Part No. Type B	Price Each	Part No. Type A	Part No. Type B	Price Each
4	1/4	THA4X4	THB4X4	\$0.06	THA4-4	---	---
4	3/8	THA4X6	THB4X6	\$0.06	THA4-6	---	---
4	1/2	THA4X8	THB4X8	\$0.09	THA4-8	---	---
4	5/8	THA4X10	THB4X10	\$0.07	THA4-10	---	---
4	3/4	THA4X12	THB4X12	\$0.07	THA4-12	---	---
4	7/8	THA4X14	---	---	---	---	---
6	3/8	THA6X6	THB6X6	\$0.04	THA6-6	---	\$0.17
6	1/2	THA6X8	THB6X8	\$0.05	THA6-8	---	---
6	3/4	THA6X12	THB6X12	\$0.07	THA6-12	---	\$0.07
8	3/8	THA8X6	THB8X6	\$0.07	THA8-6	---	\$0.07
8	1/2	THA8X8	THB8X8	\$0.07	THA8-8	---	\$0.06
8	5/8	THA8X10	THB8X10	\$0.07	THA8-10	---	---
8	3/4	THA8X12	THB8X12	\$0.08	THA8-12	---	---
8	1	THA8X16	THB8X16	\$0.11	THA8-16	---	---
10	1/2	THA10X8	THB10X8	\$0.09	THA10-8	---	\$0.10
10	5/8	THA10X10	THB10X10	\$0.11	THA10-10	---	---
10	3/4	THA10X12	THB10X12	\$0.11	THA10-12	---	---
10	1	THA10X16	THB10X16	\$0.10	THA10-16	---	---

ZINC-PLATED, 82° FLAT HEAD TYPE A ZINC-PLATED STEEL (Use slotted screws for antiques)



Size	Length	Phillips			Slotted	
		Part No. Type A	Part No. Type B	Price Each	Part No. Type A	Price Each
4	1/4	FHA4X4	FHB4X4	\$0.04	FHA4-4	---
4	3/8	FHA4X6	FHB4X6	\$0.05	FHA4-6	---
4	1/2	FHA4X8	FHB4X8	\$0.06	FHA4-8	---
4	5/8	FHA4X10	FHB4X10	---	FHA4-10	---
4	3/4	FHA4X12	FHB4X12	---	FHA4-12	---
6	3/8	FHA6X6	FHB6X6	\$0.06	FHA6-6	---
6	1/2	FHA6X8	FHB6X8	\$0.03	FHA6-8	---
6	5/8	FHA6X10	FHB6X10	\$0.05	FHA6-10	\$0.36
6	3/4	FHA6X12	FHB6X12	\$0.04	FHA6-12	---
8	3/8	FHA8X6	FHB8X6	\$0.05	FHA8-6	---
8	1/2	FHA8X8	FHB8X8	\$0.06	FHA8-8	---
8	5/8	FHA8X10	FHB8X10	\$0.04	FHA8-10	---
8	3/4	FHA8X12	FHB8X12	\$0.07	FHA8-12	---
10	1/2	FHA10X8	FHB10X8	\$0.06	FHA10-8	\$0.11
10	5/8	FHA10X10	FHB10X10	\$0.04	FHA10-10	---
10	3/4	FHA10X12	FHB10X12	---	FHA10-12	---

MS51861 SERIES SCREWS



MS numbers without the C at the end - Material: Carbon Steel Type 1016 - 1024 Finish: CAD TYPE II
MS numbers with the C at the end - Material: Stainless Steel Type 410 Finish: Passivate

Size	Length	Part No.	Price each	Part No.	Price each
#4	1/4	MS51861-12	\$0.10	MS51861-12C	\$0.20
	3/8	MS51861-14	\$0.11	MS51861-14C	\$0.21
	1/2	MS51861-15	\$0.12	MS51861-15C	\$0.22
#6	1/4	MS51861-22	\$0.12	MS51861-22C	\$0.22
	3/8	MS51861-24	\$0.13	MS51861-24C	\$0.23
	1/2	MS51861-25	\$0.13	MS51861-25C	\$0.24
	5/8	MS51861-26	\$0.14	MS51861-26C	\$0.25
	3/4	MS51861-27	\$0.15	MS51861-27C	\$0.26
	1	MS51861-29	\$0.16	MS51861-29C	---
#8	3/8	MS51861-34	\$0.12	MS51861-34C	\$0.24
	1/2	MS51861-35	\$0.14	MS51861-35C	\$0.27
	5/8	MS51861-36	\$0.16	MS51861-36C	\$0.28
#10	3/4	MS51861-37	\$0.17	MS51861-37C	\$0.30
	1	MS51861-39	\$0.18	MS51861-39C	---
	1/2	MS51861-45	\$0.22	MS51861-45C	\$0.30
	5/8	MS51861-46	\$0.18	MS51861-46C	\$0.39
	3/4	MS51861-47	\$0.19	MS51861-47C	---
1	MS51861-49	\$0.20	MS51861-49C	---	

FUEL TANK STRUCTURAL STAINLESS SCREW KITS (PER TANK)



Aircraft Model	Part No.	Price
Cessna 150/152 (Standard)	04-01005	\$42.95
Cessna 150/152 (Long Range)	04-01004	\$57.75
Cessna 172	04-01003	\$68.75
Cessna 172 (Long Range)	04-02068	\$85.75
Piper PA28 Cherokee (Standard)	04-01002	\$71.95
Piper PA28 Cherokee (Long Range)	04-01001	\$79.75
Cessna 150 Aerobat	04-01006	\$20.75
Cessna150/152 (67-77)	04-01008	\$20.25
Cessna 170AF	04-01009	\$25.00
Cessna 182F	04-01011	\$27.00
Piper Cherokee 140/150/160/180/235 (Cad. Plated)	04-01015	\$22.50

MACHINE SCREWS

BRASS INSTRUMENT SCREWS

Use brass screws for all panel installations to eliminate magnetic interference. All brass screws are coated in black oxide.

AN515 & AN520 ROUND HEAD SCREWS

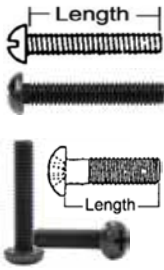

Part Number	Length (In.)	Thread Size	Price Each
AN515B6R8 (Phillips)	1/2	6-32	\$0.21
AN515B6-8 (Slot)	1/2	6-32	\$0.15
AN515B6-12 (Slot)	3/4	6-32	\$0.24
AN515B6R12 (Phillips)	3/4	6-32	\$0.18
AN515B8-16 (Slot)	1	8-32	\$0.35
AN515B10-16 (Slot)	1	10-24	\$0.72

MS35214 & MS35215 PAN HEAD SCREWS

Part No.	Length	Thread	Price	Part No.	Length	Thread	Price
MS35214-12	1/4"	4-40	\$0.16	MS35214-40	3/8"	8-32	\$0.13
MS35214-13	5/16"	4-40	\$0.11	MS35214-41	7/16"	8-32	\$0.15
MS35214-14	3/8"	4-40	\$0.08	MS35214-42	1/2"	8-32	\$0.16
MS35214-15	7/16"	4-40	\$0.09	MS35214-43	5/8"	8-32	\$0.17
MS35214-16	1/2"	4-40	\$0.13	MS35214-44	3/4"	8-32	\$0.19
MS35214-18	3/4"	4-40	\$0.13	MS35214-45	7/8"	8-32	\$0.23
MS35214-23	1/4"	6-32	\$0.10	MS35214-46	1"	8-32	\$0.23
MS35214-24	5/16"	6-32	\$0.11	MS35214-47	1-1/4"	8-32	\$0.24
MS35214-26	7/16"	6-32	\$0.16	MS35214-48	1-1/2"	8-32	\$0.29
MS35214-27	1/2"	6-32	\$0.12	MS35214-59	1"	10-24	\$0.79
MS35214-28	5/8"	6-32	\$0.12	MS35215-53	3/8"	10-32	\$0.21
MS35214-29	3/4"	6-32	\$0.12	MS35215-55	1/2"	10-32	\$0.25
MS35214-30	7/8"	6-32	\$0.19	MS35215-56	5/8"	10-32	\$0.34
MS35214-31	1"	6-32	\$0.16	MS35215-57	3/4"	10-32	\$0.23
MS35214-32	1-1/4"	6-32	\$0.20	MS35215-59	1"	10-32	\$0.28
MS35214-33	1-1/2"	6-32	\$0.22	MS35215-60	1-1/4"	10-32	-



MS24693 FLAT HEAD SCREWS (RECESSED)

Part Number	Length	Thread	Price	Part Number	Length	Thread	Price
MS24693BB2	.250	4-40	\$0.14	MS24693BB32	1.00	6-32	\$0.17
MS24693BB3	.312	4-40	\$0.24	MS24693BB33	1.13	6-32	\$0.28
MS24693BB4	.375	4-40	\$0.09	MS24693BB34	1.25	6-32	\$0.16
MS24693BB5	.438	4-40	\$0.07	MS24693BB36	1.50	6-32	\$0.30
MS24693BB6	.500	4-40	\$0.11	MS24693BB48	.375	8-32	\$0.16
MS24693BB7	.625	4-40	\$0.12	MS24693BB50	.500	8-32	\$0.17
MS24693BB24	.250	6-32	\$0.14	MS24693BB51	.625	8-32	\$0.26
MS24693BB25	.312	6-32	\$0.10	MS24693BB54	1	8-32	\$0.20
MS24693BB26	.375	6-32	\$0.13	MS24693BB56	1.25	8-32	\$0.27
MS24693BB27	.438	6-32	\$0.11	MS24693BB272	.500	10-32	\$0.18
MS24693BB28	.500	6-32	\$0.12	MS24693BB273	.625	10-32	\$0.15
MS24693BB29	.625	6-32	\$0.10	MS24693BB274	.750	10-32	\$0.30
MS24693BB30	.750	6-32	\$0.11	MS24693BB276	1.00	10-32	\$0.29
MS24693BB31	.875	6-32	\$0.12	MS24693BB278	1.25	10-32	\$0.22

STAINLESS STEEL SCREW, WASHER & STOP NUT ASSORTMENT

This 2400 piece assortment is ideal for aircraft homebuilders, owners, mechanics and FBO's. It is packaged in a handy divided storage kit and contains 2100 stainless steel screws and washers and 300 stop nuts. Kit contains 100 each of the following:

NON-STRUCTURAL MACHINE SCREWS	
Countersunk Flat Head	Truss Head
AN507C632R8	AN526C632R8
AN507C832R8	AN526C832R8
AN507C832R10	AN526C832R10
AN507C1032R8	AN526C1032R8
AN507C1032R10	AN526C1032R10

ELASTIC STOP NUTS	
AN365C632	
AN365C832	
AN365C1032	

WASHERS	
Tinnerman Countersunk	
A3135- SS- 017	(#8)
A3235- SS- 020	(#10)
Flat: AN960C6	
AN960C8 or AN960C10	

SHEET METAL SCREWS	
Truss Head Phillips, Type A (Sharp Point)	
4R x 1/2	8R x 1/2
6R x 3/8	8R x 5/8
6R x 1/2	10R x 1/2

STAINLESS STEEL HARDWARE ASSORTMENT

P/N 04-05000\$138.75

INDIVIDUAL AIRPLANE EXTERIOR STAINLESS TRIM SCREW AND WASHER KITS

These kits do not include any structural screws.

Aircraft Type	# of Pieces	Part No.	Price
BEECHCRAFT			
Baron	1310	04-04400	\$76.95
Bonanza	675	04-04300	\$58.75
Musketeer/Sport	615	04-04350	\$42.50
Sundowner	615	04-04350	\$42.50
BELLANCA			
Citabria	248	04-00990	\$29.50
Viking	-	04-00880	\$27.50
CESSNA			
120/140	310	04-01200	\$32.50
150/152	355	04-01000	\$79.75
170	310	04-01200	\$32.50
170-B	310	04-01200	\$32.50
172/172 Skyhawk	410	04-01100	\$39.50
172RG	330	04-01400	\$45.85
172 XP	520	04-01300	\$43.50
175	450	04-01500	\$41.55
177/177RG Cardinal	600	04-01600	\$53.75
180/185 Skywagon	530	04-01700	\$44.65
182RG Skylane	580	04-01900	\$46.50
188 Agwagon	775	04-02000	\$54.85
190/195	370	04-02100	\$32.95
205	510	04-02200	\$43.50
206-208 Stationair	555	04-02300	\$46.50
210 Centurion	630	04-02400	\$52.75
310/320	1110	04-02500	\$107.75
335/340	1492	04-02510	\$137.75
336/337	1347	04-02700	\$108.75
401/402	1468	04-00401	\$153.75
411/414	1342	04-02750	\$124.75
421	1580	04-02800	\$159.95
Commander - Lark/Darter	-	04-04510	\$36.85
Ercoupe - 415C/Forney	525	04-04900	\$32.50
GRUMMAN			
AA1A/AA1B	490	04-04600	\$39.50
Ag Cat	515	04-04800	\$41.50
Cheetah/Tiger	975	04-04700	\$78.75
Lake - Amphibian	265	04-04710	\$27.50
PIPER			
Aerostar	-	04-04720	\$165.95
Apache	-	04-04730	\$99.25
Arrow	615	04-03800	\$62.75
Arrow III	590	04-03810	\$62.75
Aztec	1050	04-03200	\$82.80
Cherokee 140/150/160/180/235	570	04-03600	\$54.80
Cherokee Six	455	04-04000	\$57.75
Comanche (Single)	485	04-03300	\$34.70
Comanche (Twin)	800	04-03900	\$71.75
J-3 Cub	-	04-03910	\$78.75
Navajo	2065	04-03920	\$219.95
Pawnee	1965	04-03400	\$156.75
PA28 Arrow (Fat Wing)	615	04-03800	\$62.75
PA28 Challenger/Archer	670	04-03500	\$53.85
PA28R Arrow (Tap. Wing)	590	04-03810	\$62.75
PA32R Lance	685	04-04010	\$54.95
Seneca I & II	1415	04-04100	\$109.75
Super Cub	-	04-04110	\$79.85
Tomahawk	440	04-04200	\$39.50
Tripacr/Colt	360	04-03100	\$36.90
Warrior/Archer	480	04-03700	\$39.95
Pitts - S2A	640	04-03710	\$39.95
Rockwell - 12/114	570	04-03720	\$31.50
MOONEY			
68, 77, 78	1240	04-02900	\$62.75
201/231	970	04-03050	\$74.75
M20C	1022	04-02820	\$62.75
M20-C 69, 76	-	04-03000	\$57.75
M20E/G (up to 1976)	-	04-02830	\$93.25
M20E/G (1977 & up)	-	04-02840	\$97.75
M20F	-	04-02850	\$127.95

NOTE: 10% DISCOUNT OFFERED IF CUSTOMER CAN PROVIDE US WITH TYPES AND SIZES FOR AIRCRAFT NOT LISTED.

SOCKET HEAD CAP SCREWS



**SOCKET HEAD CAP SCREW
STAINLESS STEEL-DRILLED**

Part Number	MS Number	Thread	Length	Price
NAS1352C04H4		4-40	1/4"	\$1.13
NAS1352C04H6		4-40	3/8"	\$1.39
NAS1352C06H6	MS24674-2	6-32	3/8"	\$1.22
NAS1352C06H8	MS24674-3	6-32	1/2"	\$1.30
NAS1352C08H6	MS24674-7	8-32	3/8"	\$1.76
NAS1352C08H8	MS24674-8	8-32	1/2"	\$1.74
NAS1352C08H10	MS24674-9	8-32	5/8"	\$1.58
NAS1351C3H6	MS24673-1	10-32	3/8"	\$1.79
NAS1351C3H8	MS24673-2	10-32	1/2"	\$1.74
NAS1351C3H10	MS24673-3	10-32	5/8"	\$1.85
NAS1351C4H10	MS24673-10	1/4"-28	5/8"	\$1.72
NAS1351C4H12	MS24673-11	1/4"-28	3/4"	\$2.50
NAS1351C4H14	MS24673-12	1/4"-28	7/8"	\$3.85
NAS1351C4H16	MS24673-13	1/4"-28	1"	\$2.60



**SOCKET HEAD CAP SCREW
ALLOY STEEL-DRILLED**

Part Number	MS Number	Thread	Length	Price
NAS1352-04H4P	MS24677-1	4-40	1/4"	\$1.10
NAS1352-04H6P	MS24677-2	4-40	3/8"	\$1.10
NAS1352-06H6P	MS24677-7	6-32	3/8"	\$1.26
NAS1352-06H8P	MS24677-8	6-32	1/2"	\$1.60
NAS1352-06H10P	MS24677-9	6-32	5/8"	\$1.78
NAS1352-08H6P	MS24677-14	8-32	3/8"	\$1.22
NAS1352-08H8P	MS24677-15	8-32	1/2"	\$1.38
NAS1352-08H10P	MS24677-16	8-32	5/8"	\$1.48
NAS1352-08H12P	MS24677-17	8-32	3/4"	\$1.48
NAS1351-3H6P	MS24678-9	10-32	3/8"	\$1.38
NAS1351-3H8P	MS24678-10	10-32	1/2"	\$1.43
NAS1351-3H10P	MS24678-11	10-32	5/8"	\$1.81
NAS1351-3H12P	MS24678-12	10-32	3/4"	\$1.38
NAS1351-4H10P	MS24678-21	1/4-28	5/8"	\$1.98
NAS1351-4H12P	MS24678-22	1/4-28	3/4"	\$1.88
NAS1351-4H14P	MS24678-23	1/4-28	4/8"	\$2.39
NAS1351-4H16P	MS24678-24	1/4-28	1"	\$2.20

HA



**SOCKET HEAD CAP SCREW
STAINLESS STEEL-UNDRILLED**

Part Number	MS Number	Thread	Length	Price
NAS1352C04-4	MS16995-9	4-40	1/4"	\$0.25
NAS1352C04-8	MS16995-11	4-40	1/2"	\$0.28
NAS1352C06-4	MS16995-16	6-32	1/4"	\$0.31
NAS1352C06-6	MS16995-17	6-32	3/8"	\$0.27
NAS1352C06-8	MS16995-18	6-32	1/2"	\$0.29
NAS1352C06-10	MS16995-19	6-32	5/8"	\$0.32
NAS1352C08-6	MS16995-25	8-32	3/8"	\$0.34
NAS1352C08-8	MS16995-26	8-32	1/2"	\$0.36
NAS1352C08-10	MS16995-27	8-32	5/8"	\$0.39
NAS1352C08-12	MS16995-28	8-32	3/4"	\$0.42
NAS1351C3-6	MS16996-9	10-32	3/8"	\$0.33
NAS1351C3-8	MS16996-10	10-32	1/2"	\$0.34
NAS1351C3-10	MS16996-11	10-32	5/8"	\$0.38
NAS1351C3-12	MS16996-12	10-32	3/4"	\$0.46
NAS1351C4-10	MS16996-22	1/4-28	5/8"	\$0.84
NAS1351C4-12	MS16996-23	1/4-28	3/4"	\$0.78
NAS1351C4-16	MS16996-24	1/4-28	1"	\$1.02



**SOCKET HEAD CAP SCREW
ALLOY STEEL UN-DRILLED**

Part Number	MS Number	Thread	Length	Price
NAS1352-04-4P	MS16997-9	4-40	1/4"	\$0.44
NAS1352-04-6P	MS16997-10	4-40	3/8"	\$0.37
NAS1352-04-8P	MS16997-11	4-40	1/2"	\$0.43
NAS1352-06-6P	MS16997-19	6-32	3/8"	\$0.42
NAS1352-06-8P	MS16997-20	6-32	1/2"	\$0.54
NAS1352-06-10P	MS16997-21	6-32	5/8"	\$0.54
NAS1352-08-6P	MS16997-31	8-32	3/8"	\$0.58
NAS1352-08-8P	MS16997-32	8-32	1/2"	\$0.57
NAS1352-08-10P	MS16997-33	8-32	5/8"	\$0.63
NAS1352-08-12P	MS16997-34	8-32	3/4"	\$0.63
NAS1351-3-6P	MS16998-26	10-32	3/8"	\$0.52
NAS1351-3-8P	MS16998-27	10-32	1/2"	\$0.42
NAS1351-3-10P	MS16998-28	10-32	5/8"	\$0.48
NAS1351-3-12P	MS16998-29	10-32	3/4"	\$0.59
NAS1351-4-10P	MS16998-42	1/4-28	5/8"	\$0.95
NAS1351-4-12P	MS16998-43	1/4-28	3/4"	\$1.08
NAS1351-4-14P	MS16998-44	1/4-28	7/8"	\$0.97
NAS1351-4-16P	MS16998-45	1/4-28	1"	\$0.88



AN565 SET SCREWS

Description	Thread	Length	Part No.	Price
MS1029-10	4-40	3/16	AN565AC4H3	\$2.15
MS1965-31	8-32	3/8	AN565A8H6	\$1.52
MS51021-9	4-40	1/8	AN565DC4H2	\$1.11
MS51021-10	4-40	3/16	AN565DC4H3	\$0.98
MS51021-11	4-40	1/4	AN565DC4H4	\$0.99
MS51021-21	6-32	1/8	AN565DC6H2	\$1.20
MS51021-22	6-32	3/16	AN565DC6H3	\$1.26
MS51021-23	6-32	1/4	AN565DC6H4	\$1.45
MS51021-31	8-32	3/16	AN565DC8H3	\$1.26
MS51021-32	8-32	1/4	AN565DC8H4	\$0.94
MS51029-11	4-40	1/4	AN565AC4H4	\$0.94
MS51029-17	6-32	3/16	AN565AC6H3	\$1.10
MS51029-18	6-32	1/4	AN565AC6H4	\$1.06
MS51029-27	8-32	1/4	AN565AC8H4	\$1.06
MS51029-28	8-32	5/16	AN565AC8H5	\$1.08
MS51029-29	8-32	3/8	AN565AC8H6	\$1.84
MS51963-9	4-40	1/8	AN565D4H2	\$0.99
MS51963-10	4-40	3/16	AN565D4H3	\$1.19
MS51963-11	4-40	1/4	AN565D4H4	\$1.11

Description	Thread	Length	Part No.	Price
MS51963-20	6-32	1/8	AN565D6H2	\$1.13
MS51963-21	6-32	3-16	AN565D6H3	\$1.17
MS51963-22	6-32	1/4	AN565D6H4	\$1.25
MS51963-34	8-32	3/16	AN565D8H3	\$0.98
MS51963-35	8-32	1/4	AN565D8H4	\$0.99
MS51963-36	8-32	5/16	AN565D8H5	\$0.86
MS51963-37	8-32	3/8	AN565D8H6	\$0.87
MS51964-49	10-32	1/4	AN565D1032H4	\$1.53
MS51964-50	10-32	5/16	AN565D1032H5	\$0.98
MS51964-51	10-32	3/8	AN565D1032H6	\$1.48
MS51965-17	6-32	1/8	AN565A6H2	\$1.06
MS51965-19	6-32	1/4	AN565A6H4	\$0.89
MS51965-20	6-32	5/16	AN565A6H5	\$0.87
MS51965-21	6-32	3/8	AN565A6H6	\$0.98
MS51965-28	8-32	3/16	AN565A8H3	\$1.04
MS51965-29	8-32	1/4	AN565A8H4	\$1.03
MS51965-30	8-32	5/16	AN565A8H5	\$1.14
MS51965-18	6-32	3/16	AN565A6H3	\$1.03

SCREWS



NAS333 AND NAS334 SCREWS

Material - Alloy Steel (8740)
Heat Treat - 160,000 - 180,000 PSI
Finish - Cadmium Per QQ-P-416 Type II

Thread	Grip	Length	Part No.	Price
10-32	0.125	0.531	NAS333CPA4	\$0.21
10-32	0.188	0.594	NAS333CPA4-5	\$0.22
10-32	0.250	0.656	NAS333CPA5	\$0.28
10-32	0.312	0.719	NAS333CPA5-5	\$0.24
10-32	0.375	0.781	NAS333CPA6	\$0.24
10-32	0.500	0.906	NAS333CPA7	\$0.42
10-32	0.625	1.031	NAS333CPA10	\$0.26
1/4-28	0.188	0.657	NAS334CPA5	\$0.59
1/4-28	0.312	0.781	NAS334CPA6	\$0.28
1/4-28	0.438	0.907	NAS334CPA7	\$0.29
1/4-28	0.562	1.031	NAS334CPA10	\$0.78

NAS1580 SCREWS



Offset Cruciform 100 Deg Flush Head
Material - Alloy Steel (8740) or Cres. (A-286)
Heat Treat - 160,000 - 180,000 or PSI 160,000 - 190,000 PSI
Finish - Cadmium Per AmsQQ-P-416 TYPE II or Passivate Per Ams 2700
Thread: 10-32

Dash No.	Material	Heat Treat	Finish	Grip	Length	Part No.	Price
A3T2	Alloy Steel (8740)	160,000 - 180,000 PSI	Cadmium Per Ams QQ-P-416 TYPE II	0.125	0.487	NAS1580A3T2	\$0.28
A3T3	Alloy Steel (8740)	160,000 - 180,000 PSI	Cadmium Per Ams QQ-P-416 TYPE II	0.187	0.549	NAS1580A3T3	\$0.28
A3T4	Alloy Steel (8740)	160,000 - 180,000 PSI	Cadmium Per Ams QQ-P-416 TYPE II	0.250	0.613	NAS1580A3T4	\$0.29
A3T5	Alloy Steel (8740)	160,000 - 180,000 PSI	Cadmium Per Ams QQ-P-416 TYPE II	0.312	0.675	NAS1580A3T5	\$0.30
C3T3	Cres. (A-286)	160,000 - 190,000 PSI	Passivate Per Ams 2700	0.187	0.549	NAS1580C3T3	\$0.76
C3T4	Cres. (A-286)	160,000 - 190,000 PSI	Passivate Per Ams 2700	0.250	0.613	NAS1580C3T4	\$0.77

NAS1581 SCREWS



Offset Cruciform 100 Deg Flush Head
Material - Alloy Steel (8740) or Cres. (A-286)
Heat Treat - 160,000 - 180,000 PSI or 160,000 - 190,000 PSI
Finish - Cadmium Per AmsQQ-P-416 TYPE II or Passivate Per Ams2700
Thread: 10-32

Dash No.	Material	Heat Treat	Finish	Grip	Length	Part No.	Price
F3T2 Plain Cruciform	Alloy Steel (8740)	160,000 - 180,000 PSI	Cadmium Per Ams QQ-P-416 TYPE II	0.125	0.487	NAS1581F3T2	\$0.50
F3T3 Plain Cruciform	Alloy Steel (8740)	160,000 - 180,000 PSI	Cadmium Per Ams QQ-P-416 TYPE II	0.187	0.549	NAS1581F3T3	\$0.70
F3T4 Plain Cruciform	Alloy Steel (8740)	160,000 - 180,000 PSI	Cadmium Per Ams QQ-P-416 TYPE II	0.250	0.613	NAS1581F3T4	\$0.48
F3T5 Plain Cruciform	Alloy Steel (8740)	160,000 - 180,000 PSI	Cadmium Per Ams QQ-P-416 TYPE II	0.312	0.675	NAS1581F3T5	\$0.36
F3T8 Plain Cruciform	Alloy Steel (8740)	160,000 - 180,000 PSI	Cadmium Per Ams QQ-P-416 TYPE II	0.500	0.863	NAS1581F3T8	\$0.37
F3R2 Ribbed Cruciform	Alloy Steel (8740)	160,000 - 180,000 PSI	Cadmium Per Ams QQ-P-416 TYPE II	0.125	0.487	NAS1581F3R2	\$0.48
F3R3 Ribbed Cruciform	Alloy Steel (8740)	160,000 - 180,000 PSI	Cadmium Per Ams QQ-P-416 TYPE II	0.187	0.549	NAS1581F3R3	\$0.70
F3R4 Ribbed Cruciform	Alloy Steel (8740)	160,000 - 180,000 PSI	Cadmium Per Ams QQ-P-416 TYPE II	0.250	0.613	NAS1581F3R4	\$0.40
C3T2	Cres. (A-286)	160,000 - 190,000 PSI	Passivate Per Ams 2700	0.125	0.487	NAS1581C3T2	\$0.92
C3T3	Cres. (A-286)	160,000 - 190,000 PSI	Passivate Per Ams 2700	0.187	0.549	NAS1581C3T3	\$1.06
C3T4	Cres. (A-286)	160,000 - 190,000 PSI	Passivate Per Ams 2700	0.250	0.613	NAS1581C3T4	\$0.88

NAS1802 PHILLIPS HEX HEAD SCREWS



Screw, Phillips Hex Head
Material - A-286 Corrosion Resisting Steel
Finish - Passivate Per QQ-P-35

NAS1802 Dash No.	Thread Size	Length	Part No.	Price
06-5	6-32	0.312	NAS1802-06-5	\$0.52
06-6	6-32	0.375	NAS1802-06-6	\$0.52
06-7	6-32	0.438	NAS1802-06-7	\$1.10
06-8	6-32	0.500	NAS1802-06-8	\$0.65
06-9	6-32	0.562	NAS1802-06-9	\$0.60
08-5	8-32	0.312	NAS1802-08-5	\$0.58
08-6	8-32	0.375	NAS1802-08-6	\$0.59
08-7	8-32	0.438	NAS1802-08-7	\$0.61
08-8	8-32	0.500	NAS1802-08-8	\$0.64
08-9	8-32	0.562	NAS1802-08-9	\$0.66
08-10	8-32	0.625	NAS1802-08-10	\$0.70
08-11	8-32	0.688	NAS1802-08-11	\$0.76
08-12	8-32	0.750	NAS1802-08-12	\$0.80
08-16	8-32	1.000	NAS1802-08-16	\$0.86
3-5	10-32	0.312	NAS1802-3-5	\$0.72
3-6	10-32	0.375	NAS1802-3-6	\$0.72
3-7	10-32	0.438	NAS1802-3-7	\$0.75
3-8	10-32	0.500	NAS1802-3-8	\$0.77
3-9	10-32	0.562	NAS1802-3-9	\$0.82
3-10	10-32	0.625	NAS1802-3-10	\$0.84
3-11	10-32	0.688	NAS1802-3-11	\$0.86
3-12	10-32	0.750	NAS1802-3-12	\$0.88
3-13	10-32	0.812	NAS1802-3-13	\$0.89
3-14	10-32	0.875	NAS1802-3-14	\$0.92
3-15	10-32	--	NAS1802-3-15	\$0.97
3-16	10-32	1.00	NAS1802-3-16	\$1.08

NAS4403 SCREWS



Tri-Slot 100 Deg Flat Head, Close Tolerance
Material - Alloy Steel (8740)
Heat Treat - 160,000 - 180,000
Finish - Cadmium Per AmsQQ-P-416 TYPE II
Thread: 10-32

NAS4403 Dash No.	Grip	Length	Part No.	Price
-2	0.125	0.448	NAS4403-2	\$0.30
-3	0.187	0.511	NAS4403-3	\$0.31
-4	0.250	0.573	NAS4403-4	\$0.24
-5	0.312	0.635	NAS4403-5	\$0.25
-6	0.374	0.698	NAS4403-6	\$0.26

NAS7403 SCREWS



Phillips 100 Deg Flush Head, Close Tolerance, Short Thread
Material - Alloy Steel (8740)
Heat Treat - 160,000 - 180,000
Finish - Cadmium Per AmsQQ-P-416 TYPE II
Thread: 10-32

NAS7403 Dash No.	Grip	Length	Part No.	Price
-2	0.125	0.448	NAS7403-2	\$0.80
-3	0.187	0.511	NAS7403-3	\$0.28
-4	0.250	0.573	NAS7403-4	\$0.24
-5	0.312	0.635	NAS7403-5	\$0.25
-6	0.374	0.698	NAS7403-6	\$0.33
-7	0.438	0.761	NAS7403-7	\$0.26

HA

SCREWS – TAPER PINS



NAS8603 SCREWS

Ribbed Cruciform 100 Deg Reduced Flat Head, Close Tolerance, Short Thread
Material - Alloy Steel (8740)
Heat Treat - 160,000 - 180,000
Finish - Cadmium Per AmsQQ-P-416 TYPE II
Thread: 10-32

Dash No.	Grip	Length	Part No.	Price
-1	0.062	0.385	NAS8603-1	\$1.38
-2	0.125	0.448	NAS8603-2	\$1.52
-3	0.187	0.511	NAS8603-3	\$0.64
-4	0.250	0.573	NAS8603-4	\$0.60



NAS8703 SCREWS

Ribbed Cruciform 100 Deg Reduced Flat Head, Close Tolerance, Short Thread
Material - Cres. (A-286)
Heat Treat - 160,000 - 190,000 PSI
Finish - Cadmium Per AmsQQ-P-416 TYPE II or Passivate Per Ams 2700
Thread: 10-32

Dash No.	Finish	Grip	Length	Part No.	Price
-4	Cadmium Per Ams QQ-P-416 TYPE II	0.250	0.573	NAS8703-4	\$1.56
-U2	Passivate Per Ams 2700	0.125	0.448	NAS8703U2	\$0.98
-U3	Passivate Per Ams 2700	0.187	0.511	NAS8703U3	\$1.32
-U4	Passivate Per Ams 2700	0.250	0.573	NAS8703U4	\$1.56
-U5	Passivate Per Ams 2700	0.312	0.635	NAS8703U5	\$0.78

NIELSEN TRANSFER SCREWS



Size	Part No.	Price	Size	Part No.	Price
10-24	04-03857	\$2.75	7/16-14	04-03865	\$3.35
10-32	04-03858	\$2.40	7/16-20	04-03866	\$2.27
1/4-20	04-03859	\$2.50	1/2-13	04-03867	\$3.65
1/4-28	04-03860	\$1.95	1/2-20	04-03868	\$4.40
5/16-18	04-03861	\$2.56	5/8-11	04-03869	\$3.45
5/16-24	04-03862	\$2.69	5/8-18	04-03870	\$3.45
3/8-16	04-03863	\$3.35	3/4-10	04-03871	\$3.85
3/8-24	04-03864	\$2.83	3/4-16	04-03872	\$3.85

NIELSEN TRANSFER SCREW SETS

Nielsen Transfer Screws are the original screws that Alexander started manufacturing in 1937. The design and functionality has held true to it form since the inception because it is reliable, durable and affordable. Throw a set of these transfer screws in your toolbox today and you'll immediately see the benefits of having a precision Alexander tool.



Description	Includes	Part No.	Price
#2 Coarse Screw Set	5/16"-18, 3/8"-16, 1/2"-13 (4 of each size)	04-03851	\$33.50
#3 Coarse Screw Set	7/16"-14, 1/2"-13, 5/8"-11 (4 of each size)	04-03853	\$29.45
#3 Fine Screw Set	7/16"-20, 1/2"-13, 5/8"-18 (4 of each size)	04-03854	\$29.45
#4 Coarse Screw Set	1/2"-13, 5/8"-11, 3/4"-10 (4 of each size)	04-03855	\$32.00
#4 Fine Screw Set	1/2"-20, 5/8"-18, 3/4"-16 (4 of each size)	04-03856	\$32.00



NAS4703 SCREWS

Tri-Slot 100 Deg Flat Head, Close Tolerance
Material - Alloy Steel (8740)
Heat Treat - 160,000 - 180,000
Finish - Cadmium Per AmsQQ-P-416 TYPE II
Thread: 10-32

NAS4703 Dash No.	Grip	Length	Part No.	Price
-2	0.125	0.448	NAS4703-2	\$0.40
-3	0.187	0.511	NAS4703-3	\$0.42
-4	0.250	0.573	NAS4703-4	\$0.44
-5	0.312	0.635	NAS4403-5	\$0.25



EXTERNAL SNAP RINGS

External Snap Ring. MS16624 and MS16628.
P/N MS16624-1037.....\$0.36
P/N MS16628-4078.....\$9.65

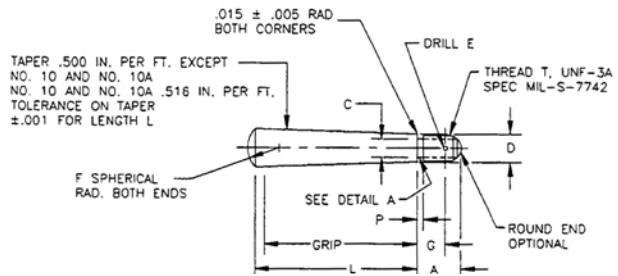

AN386 TAPER PINS



Manufactured from alloy steel, minimum tensile strength 125,000 PSI. Cadmium plated per spec. QQ-P-416, Type I, Class 3. Taper: 0.500"/ft. Use with AN975 taper pin washer, AN320 shear castle nut and cotter pin or with AN364 elastic stop nut. When installed, the small end of the tapered shank should protrude no more than 1/16" above the surface of the assembly. The first dash number is the Brown & Sharpe taper pin reamer number and the second dash number is the grip length in eighths of an inch. For undrilled threaded shank add the letter "A" after second dash number.

First Dash No.	1	2	3	4	5	6	7	8	9	10	10A
Thread T	10-32	10-32	1/4-28	5/16-24	3/8-24	7/16-20	1/2-20	9/16-18	3/4-16	7/8-14	7/8-14
A	7/16	7/16	29/64	33/64	35/64	35/64	19/32	21/32	47/64	51/64	51/64
C±.005	.141	.141	.196	.250	.313	.360	.422	.482	.660	.773	.773
D±.002	.205	.255	.317	.355	.455	.505	.605	.755	.905	1.050	1.153
E +.010, -.000	No.50 (.070)	No.50 (.070)	No.48 (.076)	No.48 (.076)	No.36 (.106)	No.36 (.106)	No.36 (.106)	No.28 (.141)	No.28 (.141)	No.28 (.141)	No.28 (.141)
F	1/2	1/2	1/2	1/2	1/2	3/4	3/4	1	1	1-1/4	1-1/4
G	5/16	5/16	21/64	21/64	23/64	23/64	13/62	15/32	35/64	39/64	39/64
P	3/64	3/64	3/64	1/16	1/16	1/16	1/16	5/64	3/32	3/32	3/32

AN386-1-6	\$12.85	AN386-2-9A	\$6.94
AN386-1-6A	\$9.85	AN386-2-10	\$11.85
AN386-1-7	\$13.80	AN386-2-12	\$13.60
AN386-1-7A	\$9.50	AN386-2-13	\$13.50
AN386-1-8	\$9.50	AN386-2-14	\$8.75
AN386-1-9	\$10.50	AN386-3-12	\$22.70
AN386-1-9A	\$7.92	AN386-3-12A	\$15.90
AN386-1-10A	\$12.50	AN386-3-14	\$10.80
AN386-1-11	\$10.75	AN386-4-13	\$25.90
AN386-2-8	\$14.90		

WASHERS

AN960 FLAT WASHERS



AN960 flat washers are used under hex nuts to provide a smooth bearing surface, as shims to obtain the correct grip length for a bolt and nut assembly, and to adjust the position of AN310 and AN320 castle nuts with respect to drilled cotter pin holes in bolts and clevis pins. Available in cadmium plated steel or anodized aluminum, and in regular and light thickness. Add the letter "L" to dash number to indicate light series. For anodized

aluminum washers, add the letters "PD" after AN number. Examples: AN960-416L is a light series cadmium plated steel washer for 1/4" dia. bolt. AN960PD-10 is an anodized aluminum washer for a 3/16" dia. bolt. AN960PD-10L is a light series anodized aluminum washer for a 3/16" dia. bolt.

NSWC FLAT WASHER KIT - Contains: • Flat AN960-916 (12 qty) • Flat AN960-616L (4 qty) • Flat AN960-416 (40 qty) • Flat AN960-716L (8 qty) • Flat AN960-616 (40 qty) • Flat AN960-816 (32 qty) • Flat AN960-816L (32 qty)P/N 04-01728 **\$17.00**

Dash #	Bolt or Screw Size	O.D. (in.)	I.D. (in.)	Thickness steel		Thickness Aluminum		Price	
				Light	Regular	Light	Regular	Steel each	Alum. each
-3	No. 3	.250	.105	.032	.032	.016	.032	\$0.05	----
-4	No. 4	.312	.125	.016	.032	.016	.032	\$0.02	\$0.05
-6	No. 6	.375	.149	.016	.032	.016	.032	\$0.03	\$0.07
-8	No. 8	.375	.174	.016	.032	.016	.032	\$0.03	\$0.05
-10	No. 10	.438	.203	.032	.063	.032	.063	\$0.06	\$0.07
-416	1/4"	.500	.265	.032	.063	.016	.063	\$0.09	\$0.09
-516	5/16"	.562	.328	.032	.063	.016	.063	\$0.08	\$0.10
-616	3/8"	.625	.390	.032	.063	.016	.063	\$0.11	\$0.19
-716	7/16"	.750	.453	.032	.063	.016	.063	\$0.15	\$0.16
-816	1/2"	.875	.515	.032	.063	.016	.063	\$0.10	\$0.17
-916	9/16"	1.062	.578	.032	.063	.016	.063	\$0.19	----
-1016	5/8"	1.188	.640	.032	.063	----	----	\$0.22	----
-1216	3/4"	1.312	.765	.032	.090	----	----	\$0.52	----

AN960C STAINLESS WASHERS

Size	Regular		Light	
	Part No.	Price Ea.	Part No.	Price Ea.
4	AN960C4	\$0.03	AN960C4L	\$0.03
5	----	---	----	---
6	AN960C6	\$0.05	AN960C6L	\$0.03
8	AN960C8	\$0.05	AN960C8L	\$0.03
3/16	AN960C10	\$0.11	AN960C10L	\$0.06
1/4	AN960C416	\$0.13	AN960C416L	\$0.04
5/16	AN960C516	\$0.19	AN960C516L	\$0.09
3/8	AN960C616	\$0.18	AN960C616L	\$0.15
7/16	AN960C716	\$0.17	AN960C716L	\$0.17
1/2	AN960C816	\$0.34	AN960C816L	\$0.15
9/16	AN960C916	\$0.46	AN960C916L	\$0.13
5/8	AN960C1016	\$1.05	AN960C1016L	\$0.25
3/4	AN960C1216	\$0.63	----	----



AN970 FLAT WASHERS

Manufactured of carbon steel, cadmium plated per QQ-P-416C, Type II, Class 2. They provide a greater bearing area than AN960 washers. Used on wooden structures under both the head of the bolt & the nut to prevent crushing the surface. Part numbers with a "C" are stainless steel.

Dash No.	Bolt Size	O.D. (in.)	I.D. (in.)	Thk (in.)	Price Each	Price per 100
-3	3/16"	.875	.203	.063	\$0.15	\$12.00
-4	1/4"	1.125	.265	.063	\$0.23	\$18.40
-C4	1/4"	1.125	.265	.063	\$0.73	---
-5	5/16"	1.375	.328	.063	\$0.29	\$23.20
-C5	5/16"	1.375	.328	.063	\$0.75	---
-6	3/8"	1.625	.390	.063	\$0.39	\$31.20
-7	7/16"	1.812	.453	.109	\$0.80	\$64.00
-8	1/2"	2.000	.515	.109	\$0.88	\$70.40
-9	9/16	2.188	.578	.125	\$2.95	---
-10	5/8"	2.375	.640	.125	\$1.71	\$136.80

MS20002C5 COUNTER SUNK WASHER

MS20002C5 Counter Sunk Washer to fit size 5/16". Cadmium plated alloy steel.....P/N 04-03974 **\$0.20**



NAS620 FLAT WASHERS

MIL-SPEC designations for flat washers, NAS620. Covered by military procurement specification FF-W-92 which has, as minimum requirements.

1. Chemical analysis
2. Process certification on protective finish
3. Workmanship
4. Magnetic permeability (stainless steel only)

Description	Part No.	Price	Description	Part No.	Price
NAS620-4	NAS620-4	\$0.03	NAS620-8L	NAS620-8L	\$0.03
NAS620-6	NAS620-6	\$0.03	NAS620-10	NAS620-10	\$0.05
NAS620-6L	NAS620-6L	\$0.03	NAS620-10L	04-00854	\$0.04
NAS620-8	NAS620-8	\$0.04			



MS15795 FLAT WASHERS

Material - 300 Series Stainless Steel
Finish - Passivate Per Astm A380

MS15795 Dash No.	O.D. (in.)	I.D. (in.)	Thickness	Price
MS15795-802	0.094	2.50	0.020	\$0.02
MS15795-803	0.125	0.250	0.022	\$0.03
MS15795-805	0.156	0.312	0.035	\$0.05
MS15795-806	0.156	0.375	0.049	\$0.03
MS15795-807	0.188	0.375	0.049	\$0.08
MS15795-808	0.219	0.438	0.049	\$0.08

NAS1515H FLAT WASHERS

Made out of Plastic Polyhexamethylene Adipamide Overall.

OEM P/N	Size No.	Thickness	Part Number	Price
NAS1515H04L	#4	1/32	04-04014	\$0.14
NAS1515H06L	#6	1/32	04-04015	\$0.08
NAS1515H08L	#8	1/32	NAS1515H08L	\$0.12
NAS1515H08	#8	1/16	04-04016	\$0.16
NAS1515H3	#10	1/16	04-04018	\$0.17
NAS1515H4	1/4	1/16	04-04019	\$0.21



NAS43HT4 SPACERS

NAS43HT4 Spacers.
Material - 4130 Steel Alloy

Manufacturer	Length	Part No.	Price
NAS43HT4-9	0.1406 = 9/64	06-02534	\$1.15
NAS43HT4-16	0.250 = 1/4	06-02529	\$1.10
NAS43HT4-22	0.34 = 11/32	06-02530	\$1.35
NAS43HT4-28	0.4375 = 7/16	06-02531	\$1.10
NAS43HT4-43	0.6718 = 43/64	06-02532	\$1.25
NAS43HT4-46	0.71875 = 23/32	06-02533	\$1.45

NORD-LOCK WEDGE LOCKING WASHERS



Nord-Lock washers secure bolted joints with tension instead of friction. It is a high quality product with documented success in many industries worldwide.

Bolt Size	Description	Part No.	Price
#10	Carbon Steel Washer NL 1/4	04-03873	\$0.65
1/4"	Carbon Steel Washer NL 1/4	04-03874	\$0.70
5/16"	Carbon Steel Washer NL8	04-03875	\$0.75
5/16"	Carbon Steel Washer NL8 sp	04-03876	\$0.85
3/8"	Carbon Steel Washer NL 3/8	04-03877	\$0.80
7/16"	Carbon Steel Washer NL11	04-03878	\$1.15
--	Carbon Steel Washer NL12 sp	04-03879	\$1.45
1/2"	Carbon Steel Washer NL 1/2	04-03880	\$1.25
1/2"	Carbon Steel Washer NL 1/2 sp	04-03881	\$1.22

HA

WASHERS



MS35338 LOCK WASHERS

MS35338 split, helical lock washers are made of carbon steel, cadmium plated per QQ-P-416A, Type II, Class 3. They replace AN935 medium-weight washers. Formerly AN935.

Cad. Plated			Stainless	
Size	Part No.	Price	Part No.	Price
6	MS35338-41	\$0.02	MS35338-136	\$0.03
8	MS35338-42	\$0.02	MS35338-137	\$0.04
10	MS35338-43	\$0.03	MS35338-138	\$0.05
1/4	MS35338-44	\$0.05	MS35338-139	\$0.12
5/16	MS35338-45	\$0.07	MS35338-140	\$0.19
3/8	MS35338-46	\$0.09	MS35338-141	\$0.49
7/16	MS35338-47	\$0.13	MS35338-142	\$0.49
1/2	MS35338-48	\$0.25	MS35338-143	\$0.64

MS35333 & MS35335 LOCK WASHERS



Type B
External
Teeth

Type A
Internal
Teeth

Provide efficient locking action by spring tension and biting action of tapered twisted teeth. Made of 1050 spring steel and cadmium plated per specification QQ-P-416A, Type II, Class 3. Available with internal teeth (Type A) or external teeth (Type B).

Type	Size	Cad Plated Part No.	Price Cad. Plated	Stainless Part No.	Price Stainless
Type A	6	MS35333-37	\$0.02	MS35333-71	\$0.10
Type A	8	MS35333-38	\$0.03	MS35333-72	\$0.08
Type A	10	MS35333-39	\$0.02	MS35333-73	\$0.06
Type A	1/4	MS35333-40	\$0.03	MS35333-74	\$0.14
Type A	5/16	MS35333-41	\$0.05	MS35333-75	\$0.21
Type A	3/8	MS35333-42	\$0.80	MS35333-76	\$0.32
Type A	7/16	MS35333-43	\$0.12	MS35333-77	\$0.36
Type A	1/2	MS35333-44	\$0.11	MS35333-78	\$0.77
Type A	5/8	MS35333-46	\$1.89	--	--
Type B	6	MS35335-30	\$0.03	MS35335-58	\$0.10
Type B	8	MS35335-31	\$0.03	MS35335-59	\$0.11
Type B	10	MS35335-32	\$0.03	MS35335-60	\$0.12
Type B	1/4	MS35335-33	\$1.75	MS35335-61	\$0.14
Type B	5/16	MS35335-34	\$0.08	MS35335-62	\$0.31
Type B	3/8	MS35335-35	\$0.08	--	--
Type B	1/2	MS35335-37	\$0.14	--	--



TOOTH LOCKWASHER

MIL-SPEC designations for tooth lockwashers include, but are not limited to MS35335. These are covered by military procurement specification FF-W-100

Nominal Screw Size	Inside Diameter		Outside Diameter		Material Thickness		MS 35335 Steel Plated	Part No.	Price
	Min	Max	Min	Max	Min	Max			
9/16	0.576	0.596	0.960	0.985	0.037	0.045	-38	04-00099	\$0.28
3/4	0.768	0.795	1.220	1.260	0.047	0.055	-40	04-00101	\$0.76
7/8	0.897	0.927	1.380	1.410	0.052	0.060	-41	04-00103	\$0.56

NAS549 PHENOLIC WASHERS

NAS549-10 Phenolic insulating washers for #10 screws. Size: 13/64" I.D. x 7/16" O.D. x 1/16 thick.....\$0.17 Ea.

G-8 TINNEMAN WASHERS



A No. 8 'Tinnerman' style washer with the same O.D. as a No. 10 (0.75). Great for those oversize holes in fairings. Unlike the No. 10 washer with a No. 8 screw, these washers will tighten down on the fairing (not bottom out on the cone) thus providing the proper "clamp up" between the fastener and the fairing. The G-8 washers are Made in the USA from 304 (1/2 hard) Stainless Steel and are machine tumbled for a shiny finish.

P/N 04-01989\$0.35



TINNEMAN COUNTERSUNK WASHERS

For use with 100° flat-head screws such as MS24693 and MS24694 machine screws and NAS548 sheet metal screws to provide reinforced, low-profile attachments. Made of spring steel, Zinc Plated.

Part No.	Screw Size	I.D. In.	O.D. In.	Price Each	Price per 100
A3236-012-193	#6	.140	.50	\$0.25	---
A3135-017-193	#8	.171	.56	\$0.18	\$14.40
A3235-028-193	#10	.196	.75	\$0.15	\$12.00

NYLON WASHERS

Part No.	Thread Size	Price Ea.
04-00219	#4	\$0.03
04-00216	#6	\$0.04
04-00217	#8	\$0.04
04-00218	#10	\$0.03

Less 20% Discount on 100 per size

100° CSK STAINLESS WASHERS



Use with 100° flathead screws to provide reinforced, low-profile attachments.

Size	Dimensions	Part No.	Price
6	.500 OD x .012 T	04-00397	\$0.29
8	.562 OD x .017 T	04-00392	\$0.20
10	.750 OD x .020 T	04-00398	\$0.23

Less 20% Discount on 100 per size



AN975 TAPER PIN WASHERS

Taper pin washers are used with AN386 threaded taper pins. Manufactured of steel, cadmium plated per QQ-P-416, Type II, Class 2.

AN975 Dash #	Fits Taper Pin #	Price Ea.
-3	1, 2	\$4.95
-4	3	\$2.15
-5	4	\$3.40
-6	5	\$4.40

82° COUNTERSUNK WASHERS



Finishing washers are used in non-structural interior and upholstery applications. The parts covered by NAS390 & NAS391 are getting harder to procure and do not necessarily conform exactly to all of the dimensions stated on the specs. Commercial

equivalents can be supplied and are suggested. These are non-critical washers that are readily available and cost effective.

Screw or Bolt Size	Countersink Washer Part No.	Price		Flush Washer Part No.	Price	
		Each	100		Each	100
#4	04-03898	\$0.12	\$9.60	NAS390B4P	--	--
#6	04-03899	\$0.15	\$12.00	04-03895	\$0.09	\$7.20
#8	04-03901	\$0.11	\$8.80	04-03896	\$0.09	\$7.20
#10	04-01946	\$0.13	\$10.40	04-03897	\$0.08	\$6.40

POLYMER SPINNER WASHERS



Propeller spinner washers are typically made from thin nylon. They are usually replaced every time the spinner is removed because the screw pressure against the spinner curvature causes the nylon washers to fail. Instead of nylon, these washers are machined from an extruded billet of a, very tough polymer material – the toughest we

make – so they won't crack or extrude. The washers easily conform to the spinner's curved surface and will serve without replacement for a very long time. In fact, they may never need replacement! Fits a # 10 screw, with a diameter and thickness to suit the round head stainless

Screws Not Included Packaged In Bags Of 25.

P/N 05-12883\$104.00

CLEVIS PINS - COTTER PINS



MS24665 COTTER PINS (FORMERLY AN380)

MS24665 cotter pins are stocked in cadmium plated steel (formerly AN380) and in passivated corrosion resisting steel (formerly AN381) in the priced sizes listed below. Other sizes available on special order. Write for quotation.

Assortment of 100 Cadmium Plated Cotter Pins
P/N 04-05050 \$17.50

CADMIUM PLATED				CORROSION RESISTANT STEEL			
Part No.	AN380 Dash No.	Dia. & Length	Price	Part No.	AN381 Dash No.	Dia. & Length	Price
MS24665-132	-2-2	1/16 X 1/2	\$0.23	MS24665-22	-1-8	1/32 X 1/2	\$0.25
MS24665-134	-2-3	1/16 X 3/4	\$0.16	MS24665-24	-1-12	1/32 X 3/4	\$0.22
MS24665-136	-2-4	1/16 X 1	\$0.11	MS24665-26	-1-16	1/32 X 1	\$0.10
MS24665-138	-2-5	1/16 X 1-1/4	\$0.17	MS24665-151	-2-8	1/16 X 1/2	\$0.14
MS24665-140	-2-6	1/16 X 1-1/2	\$0.21	MS24665-153	-2-12	1/16 X 3/4	\$0.12
MS24665-142	-2-7	1/16 X 1-3/4	\$0.19	MS24665-155	-2-16	1/16 X 1	\$0.18
MS24665-143	-2-8	1/16 X 2	\$0.21	MS24665-157	-2-20	1/16 X 1-1/4	\$0.25
MS24665-208	-	5/64 X 1/2	\$0.15	MS24665-159	-2-24	1/16 X 1-1/2	\$0.14
MS24665-281	-3-2	3/32 X 1/2	\$0.09	MS24665-161	-2-28	1/16 X 1-3/4	\$0.25
MS24665-283	-3-3	3/32 X 3/4	\$0.14	MS24665-162	-2-32	1/16 X 2	\$0.21
MS24665-285	-3-4	3/32 X 1	\$0.17	MS24665-227	-25-8	5/64 X 1/2	\$0.23
MS24665-287	-3-5	3/32 X 1-1/4	\$0.21	MS24665-229	-25-12	5/64 X 3/4	\$0.22
MS24665-289	-3-6	3/32 X 1-1/2	\$0.19	MS24665-298	-3-8	3/32 X 1/2	\$0.24
MS24665-292	-3-8	3/32 X 2	\$0.22	MS24665-300	-3-12	3/32 X 3/4	\$0.25
MS24665-349	-4-2	1/8 X 1/2	\$0.08	MS24665-302	-3-16	3/32 X 1	\$0.26
MS24665-351	-4-3	1/8 X 3/4	\$0.14	MS24665-304	-3-20	3/32 X 1-1/4	\$0.34
MS24665-353	-4-4	1/8 X 1	\$0.17	MS24665-306	-3-24	3/32 X 1-1/2	\$0.34
MS24665-355	-4-5	1/8 X 1-1/4	\$0.15	MS24665-309	-3-32	3/32 X 2	\$0.37
MS24665-357	-4-6	1/8 X 1-1/2	\$0.12	MS24665-366	-4-8	1/8 X 1/2	\$0.29
MS24665-359	-4-7	1/8 X 1 3/4	\$0.17	MS24665-368	-4-12	1/8 X 3/4	\$0.20
MS24665-360	-4-8	1/8 X 2	\$0.21	MS24665-370	-4-16	1/8 X 1	\$0.40
MS24665-362	-4-10	1/8 X 2-1/2	\$0.26	MS24665-372	-4-20	1/8 X 1-1/4	\$0.37
MS24665-426	-5-9	5/32 X 2	\$0.22	MS24665-374	-4-24	1/8 X 1-1/2	\$0.47
MS24665-498	-6-8	3/16 X 2	\$0.36	MS24665-377	-4-32	1/8 X 2	\$0.57
MS24665-500	-6-10	3/16 X 2 1/2	\$0.24	MS24665-379	-4-40	1/8 X 2-1/2	\$0.51
				MS24665-444	-5-32	5/32 X 2	\$0.67
				MS24665-516	-6-32	3/16 X 2	\$0.93
				MS24665-518	-6-40	3/16 X 2 1/2	\$0.96

Discount: 25% for quantities of 100 or more of the same Part No.

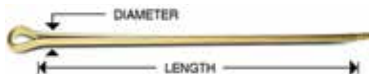

MS9245 SPLIT COTTER PINS

Material - Cres Gr. 321 Per Ams 7211
Heat Treat - 1200°F
Finish - Gray To Black Color From 1200°F Heating

MS9245 Dash No.	Dia. & Length	Part Number	Price
-21	1/16 x 1/4	MS9245-21	\$0.17
-22	1/16 x 5/16	MS9245-22	\$0.25
-23	1/16 x 3/8	MS9245-23	\$0.17
-24	1/16 x 7/16	MS9245-24	\$0.17
-25	1/16 x 1/2	MS9245-25	\$0.22
-27	1/16 x 5/8	MS9245-27	\$0.23
-28	1/16 x 3/4	MS9245-28	\$0.40
-43	3/32 x 9/16	MS9245-43	\$0.22
-44	3/32 x 5/8	MS9245-44	\$0.56
-45	3/32 x 3/4	MS9245-45	\$0.34



RING COTTERS

MB Spring Wire, Zinc Coated or Type 302 Stainless Steel.

Manufacturer	O.D. x Wire Diameter	Use on Diameter	Part No.	Price
3703	5/8 x .048	3/16 - 1/4	04-03448	\$0.13
3705	3/4 x .048	1/4 - 5/16	04-03449	\$0.07
3707	1 x .062	3/8 - 7/16	04-03450	\$0.07
3709	1-1/8 x .072	7/16 - 1/2	04-03451	\$0.17



CLEVIS PINS

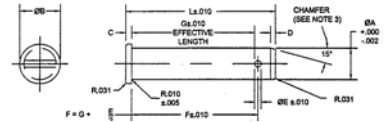

Made of alloy steel per specification MIL-P-5673 and cadmium plated per QQ-P-416, Type II, Class 3. Provided with drilled hole for cotter pin. Used with clevis forks and in secondary controls which are not subjected to continuous operation. Order by AN number and dash number. Example: AN395-41 is a 5/16" dia. pin with an effective length of 1-9/32". Equivalent MS number is MS20392-4C41. **Less 20% in lots of 25 per size. Request quotation on unlisted sizes. Note: Clevis pin prices fluctuate with changes in cost/availability at suppliers.**

Dash No.	Effective Length (In.)	AN392 MS20392 -1C 1/8"	AN393 MS20392 -2C 3/16"	AN394 MS20392 -3C 1/4"	AN395 MS20392 -4C 5/16"	AN396 MS20392 -5C 3/8"
-7	7/32	\$0.42	\$0.51	--	--	--
-9	9/32	\$0.67	\$0.84	--	--	--
-11	11/32	\$0.63	\$0.73	\$0.77	\$2.67	--
-13	13/32	\$0.55	\$0.65	\$0.77	--	--
-15	15/32	\$0.66	\$0.66	\$0.60	\$2.66	--
-17	17/32	\$0.59	\$0.85	\$0.89	\$1.38	\$2.72
-19	19/32	\$0.56	\$0.73	\$0.65	\$1.57	\$2.55
-21	21/32	\$0.66	\$0.61	\$0.96	\$2.68	--
-23	23/32	\$0.62	\$0.73	\$0.70	\$2.51	\$2.23
-25	25/32	\$1.14	\$0.72	\$1.39	\$2.32	\$8.50
-27	27/32	\$0.65	\$0.66	\$0.77	\$1.45	--
-29	29/32	\$0.77	\$1.32	\$1.01	\$2.37	--
-31	31/32	\$0.97	\$0.82	\$0.84	\$1.16	--
-33	1-1/32	\$0.69	\$0.65	\$0.90	\$2.95	--
-35	1-3/32	\$0.73	\$0.62	\$0.73	\$1.21	\$3.35
-37	1-5/32	\$0.99	\$1.12	\$1.08	\$1.75	--
-39	1-7/32	\$0.79	\$0.84	\$1.12	\$0.97	--
-41	1-9/32	\$0.83	\$0.90	\$0.97	\$1.11	\$1.63
-43	1-11/32	\$4.80	\$0.89	\$0.94	\$2.20	--
-45	1-13/32	\$1.59	\$0.77	\$1.04	\$1.42	\$5.35
-47	1-15/32	\$1.33	\$0.70	\$1.30	\$2.73	\$1.54
-49	1-17/32	\$1.10	\$1.15	\$1.28	--	--
-51	1-19/32	--	\$0.99	\$2.09	\$1.26	--
-53	1-21/32	\$1.25	\$1.77	\$1.24	\$1.79	\$5.85
-55	1-23/32	\$1.38	\$1.80	\$0.98	--	\$7.88
-57	1-25/32	\$1.54	\$1.32	\$1.57	\$2.78	--
-59	1-27/32	\$3.35	\$1.12	\$1.65	--	\$3.80
-61	1-29/32	\$2.58	\$1.47	\$1.26	--	--
-63	1-31/32	\$3.80	\$1.43	\$2.72	\$7.50	\$2.93
-65	2-1/32	\$2.45	\$2.12	\$0.89	--	--
-67	2-3/32	\$6.65	\$1.75	\$2.71	--	\$2.71
-69	2-5/32	--	\$0.97	\$2.76	\$1.37	\$1.99
-71	2-7/32	--	\$2.12	--	--	--
-73	2-9/32	--	\$3.45	\$2.46	--	--
-75	2-11/32	--	--	\$1.22	--	CALL
-79	2-15/32	--	\$1.45	\$3.95	--	--
-81	2-17/32	--	\$5.35	\$3.80	--	\$9.50
-83	2-19/32	--	\$5.35	--	--	--
-85	2-21/32	--	\$1.69	\$1.69	\$3.99	--
-87	2-23/32	--	\$4.70	--	--	--
-89	2-25/32	--	\$2.90	--	\$2.74	--
-91	2-27/32	--	--	--	--	--
-93	2-29/32	--	\$2.58	--	--	--
-95	2-31/32	--	--	\$3.35	--	--
-97	3-1/32	--	--	\$5.80	--	--
-99	3-3/32	--	--	--	--	--
-101	3-5/32	--	--	--	--	--

AN397-27 - 7/16" P/N AN397-27 \$25.50



LOCK PINS

AN415-2 corrosion resistant steel wire cowl lock pins 1-15/16" long, .080" dia. wire.

P/N AN415-2 \$0.84 Ea. \$67.20 for 100
Commercial steel cadmium plated wire lock pins 1-1/4" long, .062" dia. wire.
P/N 04-05100 \$0.14 Ea. \$11.20 for 100



COWLING SAFETY PINS

Positive locking pins that can be readily used without aid of tools. Made of spring steel, cadmium plated, 1-1/16" long.

.051" Wire Dia. AN416-1 \$0.32 Ea. \$25.60/100
.041" Wire Dia. AN416-2 \$0.32 Ea. \$25.60/100



TUBULAR PIN MS16562

MS16562-224 P/N 04-01715 \$0.65
NASM16562-16 P/N 05-11917 \$1.60

CHERRY COMMERCIAL RIVETS

CHERRY AEROSPACE RIVETS - SELF-PLUGGING CHERRY RIVETS

100° COUNTERSUNK (CR9162)



The self-plugging Cherry Blind Rivet is a 2-piece assembly - a hollow rivet and an inner member or stem, drawn into or through the hollow rivet. Cherry CR162 & CR163 series rivets are now replaced by CR9162 & CR9163 series rivets which are less expensive but does require the use of a rivet gun that comes with the req. nosepiece. Pulling Head (required)P/N 04-01515\$772.00
G-29 Rivet Gun - Comes equipped with a 728A9-3 nosepiece to install 3/32" rivets and has a 728A9-104 nosepiece stored in the handle for installing 1/8" rivets.....P/N 12-00701\$161.75

UNIVERSAL HEAD (CR 9163)



Part No.	Head Style	Nominal Dia.	Grip Range	Price		
				Each	100	1000
CR9162-4-2	Csk	1/8"	.063-.125	\$0.34	\$30.60	\$272.00
CR9162-4-4			.188-.250	\$0.49	\$44.10	\$392.00
CR9162-4-6			.313-.375	\$0.71	\$63.90	\$568.00
CR9162-4-8			.438-.500	\$0.57	\$51.30	\$456.00
CR9163-4-2	Univ.	1/8"	.063-.125	\$0.39	\$35.10	\$312.00
CR9163-4-4			.188-.250	\$0.50	\$45.00	\$400.00
CR9163-4-6			.313-.375	\$1.48	\$133.20	\$1,184.00
CR9163-5-2	Univ.	5/32"	.063-.125	\$0.67	\$60.30	\$536.00

CHERRY N RIVETS

Break mandrel rivets Conform to MIL-R-24243 & IFI-114 Standards



LOW COST

Substantial savings in installed costs can be realized when Cherry N Rivets are substituted for spotwelds, screws or bolts.

FAST INSTALLATION

Quick and easy to use with hand or power riveters, Cherry N Rivets have endless fastening applications in manufacturing, maintenance.

UNIQUE FEATURES

Unusual mandrel design of Cherry N Rivets holds rivet and mandrel firmly together prior to installation and insures positive mandrel retention in the installed rivet.

NO MANDREL POP OUTS—

As the mandrel is drawn into the rivet, the end of the rivet sleeve closes in an elliptical configuration... locking the mandrel firmly in place!

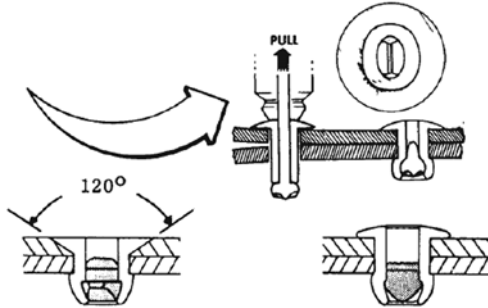

FLUSH HEAD PROTRUDING HEAD CHERRY N RIVET IDENTIFICATION CODE

First letter is rivet material:

A = 5052 Aluminum B = 5056 Aluminum C = Stainless
 M = Monel S = Steel U = Copper

Second letter is mandrel material:

A = 7178 Aluminum S = Steel C = Stainless

Third letter is head style:

P = Protruding L = Large C = Flush

First number is rivet diameter in 32nds of an inch:

For example,—4 is 4/32nds or 1/8" diameter

Second number is rivet maximum grip length in 16ths of an inch:

For example,—6 is 6/16ths or 3/8" grip length

MINIMUM RIVET SHEAR AND TENSILE STRENGTH (IBS.) CHERRY N RIVETS

Rivet Dia. Mand.	BS Series Alum Rivet Steel Mand.		MS Series Monel Rivet Steel Mand.		CC Series Stainless Rivet Stainless	
	Grade 19		Grade 40		Grade 51	
	Shear	Tens	Shear	Tens	Shear	Tens
3/32	125	175	200	300	230	280
1/8	200	325	350	525	450	600
5/32	325	450	600	900	750	1000
3/16	430	650	750	1100	1000	1300
1/4	750	1050	1450	2150	1700	2250

CHERRY Q RIVETS

Structural—Self-plugging rivets



HIGH SHEAR STRENGTH

Cherry Q Rivet mandrel plugs the entire length of the rivet sleeve, providing full shear strength values for structural or load-bearing applications.

SEALING CAPABILITY

Specially designed mandrel of the Q Rivet is engineered to effect a seal, upon installation which offers resistance to leakage.

VIBRATION RESISTANT

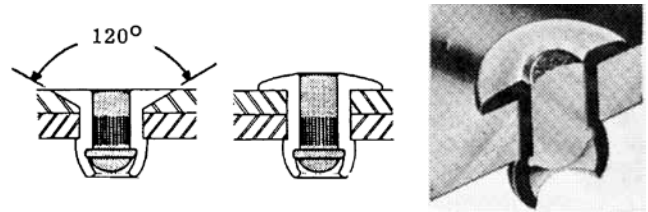

Rivet sleeve curls over end of mandrel to insure its positive retention.

FLUSH HEAD PROTRUDING HEAD CHERRY Q RIVET IDENTIFICATION CODE

First letter is rivet material:

A = 5052 Aluminum B = 5056 Aluminum C = Stainless
 M = Monel S = Steel

Second letter is mandrel material:

A = 7178 Aluminum S = Steel C = Stainless

Third letter is head style:

P = Protruding L = Large C = Flush

Fourth letter is type of rivet:

Q = Cherry Q Rivet, structural, self-plugging

First number is rivet diameter in 32nds of an inch:

For example,—6 is 6/32nds or 3/16" diameter

Second number is rivet maximum grip length in 1/16 of an inch:

For example,—8 is 8/16ths or 1/2" grip length

MINIMUM RIVET SHEAR AND TENSILE STRENGTH (IBS.) CHERRY Q RIVETS

Rivet Dia. Mand.	BS Series Alum Rivet Steel Mand.		MS Series Monel Rivet Steel Mand.		CC Series Stainless Rivet Stainless	
	Grade 19		Grade 40		Grade 51	
	Shear	Tens	Shear	Tens	Shear	Tens
5/32	525	450	950	900	1050	1000
3/16	750	650	1450	1100	1650	1300
1/4	1250	1050	2350	2150	2450	2250

NOTE: SUBJECT TO PRICE AND AVAILABILITY OF CHERRY BRAND RIVETS. EQUIVALENT RIVETS MAY BE FURNISHED.

WWW.AIRCRAFTSPRUCE.COM

CHERRY "POP" RIVETS

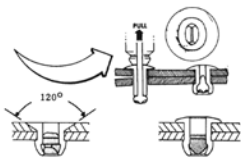

For conversion of the most frequently used "Pop" rivets to the corresponding CHERRY numbers, see the following table. **Note: SUBJECT TO PRICE AND AVAILABILITY OF CHERRY BRAND RIVETS. EQUIVALENT RIVETS MAY BE FURNISHED.**

Attention: Avdel has changed the mandrel design for some of their Cherry "N" Rivets. The change has not affected the strength of the rivet.

CHERRY COMMERCIAL RIVET PRICE TABLE

G

Grip is total of material thickness

CHERRY – Commercial rivets with maximum grip length greater than the material thickness may be substituted for a rivet of the required grip length.

HA

Cherry Rivet		USM "POP" Rivet Equiv.*	Rivet Dia.	Drill Size	Cherry Max Rivet Grip Length	Price**					
Type	Number					Price Ea. 1-99	Price Per 100 10% Discount	Price for 600 12% Discount	Price for 1000 15% Discount	Price for 3000 18% Discount	Price for 10,000 20% Discount
"N"	BSP-41	AD41BS	1/8"	30	Up to .062	\$0.09	\$8.10	\$47.52	\$76.50	\$221.40	\$720.00
	BSPS-42				.063-.125	\$0.05	\$4.50	\$26.40	\$42.50	\$123.00	\$400.00
	BSPS-43				.126-.187	\$0.05	\$4.50	\$26.40	\$42.50	\$123.00	\$400.00
	BSPS-44				.188-.250	\$0.08	\$7.20	\$42.24	\$68.00	\$196.80	\$640.00
	BSP-46				.313-.375	\$0.12	\$10.80	\$63.36	\$102.00	\$295.20	\$960.00
	BSP-48				.438-.500	\$0.08	\$7.20	\$42.24	\$68.00	\$196.80	\$640.00
"N"	BSCS-34	BSC-34	3/32"		.126-.250	\$0.30	\$27.00	\$158.40	\$255.00	\$738.00	\$2,400.00
	BSC-43	AK43BS	1/8"	30	.126-.187	\$0.11	\$9.90	\$58.08	\$93.50	\$270.60	\$880.00
	BSC-44	44BS			.188-.250	\$0.06	\$5.40	\$31.68	\$51.00	\$147.60	\$480.00
	BSC-46	A46SC	1/8"		.313-.375	\$0.17	---	---	---	---	---
"N"	MSP-32	MD319BS	3/32"	41	.020-.125	\$0.30	\$27.00	\$158.40	\$255.00	\$738.00	\$2,400.00
	-42	424BS	1/8"		.063-.125	\$0.44	\$39.60	\$232.32	\$374.00	\$1,082.40	\$3,520.00
	-43	429BS			.126-.187	\$0.27	\$24.30	\$142.56	\$229.50	\$664.20	\$2,160.00
	-44	435BS			.188-.250	\$0.39	\$35.10	\$205.92	\$331.50	\$959.40	\$3,120.00
	-45	440BS			.251-.312	\$0.23	\$20.70	\$121.44	\$195.50	\$565.80	\$1,840.00
	-54	530BS	5/32"	20	.126-.250	\$0.43	\$38.70	\$227.04	\$365.50	\$1,057.80	\$3,440.00
"N"	CCC-32	MK319BS	3/32"	41	.020-.125	\$0.13	\$11.70	\$68.64	\$110.50	\$319.80	\$1,040.00
	-42	424BS	1/8"	30	.062-.125	\$0.11	\$9.90	\$58.08	\$93.50	\$270.60	\$880.00
	-44	444BS	1/8"	30	.188-.250	\$0.10	\$9.00	\$52.80	\$85.00	\$246.00	\$800.00
"N"	CCP-32		3/32"		.020-.125	\$0.15	\$13.50	\$79.20	\$127.50	\$369.00	\$1,200.00
	CCP-42	SSD42SSDS	1/8"	30	.062-.125	\$0.13	\$11.70	\$68.64	\$110.50	\$319.80	\$1,040.00
	CCP-43		1/8"	30	.126-.187	\$0.16	\$11.70	\$68.64	\$110.50	\$319.80	\$1,040.00
	-44				.188-.250	\$0.11	\$9.90	\$58.08	\$93.50	\$270.60	\$880.00
	-46			30	.313-.375	\$0.20	\$18.00	\$105.60	\$170.00	\$492.00	\$1,600.00
"N"	SSP-42		1/8"	30	.062-.125	\$0.09	\$8.10	\$47.52	\$76.50	\$221.40	\$720.00
"N"	-44				.188-.250	\$0.12	\$10.80	\$63.36	\$102.00	\$295.20	\$960.00
	-45		1/8"		.251-.312	\$0.17	\$15.30	\$89.76	\$144.50	\$418.20	\$1,360.00
	04-01952	CSPS4-4	1/8"	30	.188-.250	\$0.32	\$28.80	\$168.96	\$272.00	\$787.20	\$2,560.00
	04-01953	CSPS4-8	1/8"	30	.438-.500	\$0.79	\$71.10	\$417.12	\$671.50	\$1,943.40	\$6,320.00
"N"	SSC-43		1/8"		.126-.187	\$0.17	\$30.60	\$68.64	\$110.50	\$319.80	\$2,720.00
	SSC-44	S44SC	1/8"		.188-.250	\$0.34	\$30.60	\$179.52	\$289.00	\$836.40	\$2,720.00
"Q"	BSPQ-41	AD41H	1/8"	30	Up to .062	\$0.32	\$28.80	\$168.96	\$272.00	\$787.20	\$2,560.00
	-42	AD42H		30	.062-.125	\$0.21	\$18.90	\$110.88	\$178.50	\$516.60	\$1,680.00
	-43	AD43H			.126-.187	\$0.22	\$19.80	\$116.16	\$187.00	\$541.20	\$1,760.00
	-44	AD44H			.188-.250	\$0.35	\$31.50	\$184.80	\$297.50	\$861.00	\$2,800.00
	-46	AD46H			.313-.375	\$0.25	\$22.50	\$132.00	\$212.50	\$615.00	\$2,000.00
"Q"	AAPQ-42	AD43H	1/8"	30	.125	\$0.23	\$20.70	\$121.44	\$195.50	\$565.80	\$1,840.00
	-44	AD44H		30	.250	\$0.26	\$23.40	\$137.28	\$221.00	\$639.60	\$2,080.00
	CCPQ-43	CCPQ-43	1/8"	30	.337	\$0.49	\$44.10	\$258.72	\$416.50	\$1,205.40	\$3,920.00
	CCPQ-44	CCPQ-44	1/8"	30	.400	\$0.40	---	---	---	---	---

*All USM "Pop" rivets are 1/64" larger than nominal diameter. Presented here for cross reference purposes only. **Quotations on larger quantities.

RIVETS – RIVET NUTS

CLOSED END POP RIVETS



Model	Head	Size	Grip	Part No.	Price
AD42H	Dome	1/8"	.063-.125	04-02334	\$0.09
AD43H	Dome	1/8"	.125-.187	04-02335	\$0.22
AK42H	CSK	1/8"	.063-.125	04-02336	\$0.15
AK43H	CSK	1/8"	.125-.187	04-02337	\$0.15

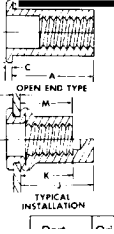

RIVET NUTS (OPEN END)

The Rivet nut is a one-piece internally threaded and counterbored tubular aluminum rivet that can be pulled up or headed while working entirely from one side, forming a bulge or head on the blind side. This upset is large enough to resist being pulled through metal or plastic even under conditions of eccentric load. It overcomes the difficulty of installing brackets, handles or other attachments to tubular pieces.

FLAT HEAD

Part Number	Type	Grip Range	Length	Thread	Price Each
NAS1329A06K75	Keyed	.010-.075	.438	6-32	\$0.17
NAS1329A06-75	Keyless	.010-.075	.438	6-32	\$0.17
NAS1329A06K120	Keyed	.075-.120	.500	6-32	\$0.26
NAS1329A06-120	Keyless	.075-.120	.500	6-32	\$0.23
NAS1329A08K75	Keyed	.010-.075	.438	8-32	\$0.22
NAS1329A08-75	Keyless	.010-.075	.438	8-32	\$0.22
NAS1329A08K120	Keyless	.075-.120	.500	8-32	\$0.36
NAS1329A08-120	Keyless	.075-.120	.500	8-32	\$0.20
NAS1329A3K80	Keyed	.010-.075	.438	10-32	\$0.23
NAS1329A3-80	Keyless	.010-.075	.438	10-32	\$0.26
AEA10K140	Keyed	.075-.140	.500	10-32	\$0.78
AEA10-140	Keyless	.075-.140	.500	10-32	\$0.63

COUNTERSUNK HEAD

Part Number	Type	Grip Range	Length	Thread	Price Each
NAS1330A06K106	Keyed	.065-.106	.500	6-32	\$0.25
NAS1330A06-106	Keyless	.065-.106	.500	6-32	\$0.29
NAS1330A08K106	Keyed	.065-.106	.500	8-32	\$0.31
NAS1330A08-106	Keyless	.065-.106	.500	8-32	\$0.28

AVEX NON-STRUCTURAL BLIND RIVETS

Avex non- structural blind rivets, with aluminum body and steel stem, are similar to the Cherry BSP and BSC commercial rivets. We stock the standard dome head, 120° countersunk head and the low-profile "Lo-Pro" dome head rivets in diameters up to 3/16".

Head Style	Part No.	Dia.	Grip Range	Price		
				Each	100	1000
Dome	1601-0410	1/8"	To .187	\$0.09	\$8.10	\$72.00
	1601-0414	1/8"	To .312	\$0.10	\$9.00	\$80.00
	1601-0613	3/16"	To .250	\$0.13	\$11.70	\$104.00
	1601-0619	3/16"	To .437	\$0.12	\$10.80	\$96.00
	04-01949	5/32"	.046-.250	\$0.12	\$10.80	\$96.00
Counter-sunk (120°)	1604-0412	1/8"	To .250	\$0.08	\$7.20	\$64.00
	1604-0514	5/32"	To .312	\$0.13	\$11.70	\$104.00
	1604-0615	3/16"	To .312	\$0.21	\$18.90	\$168.00
Lo-Pro	1661-0613	3/16"	To .250	\$0.11	\$9.90	\$88.00
	1661-0621	3/16"	To .500	\$0.45	\$40.50	\$360.00

PULL RIVETS



Blind open end pull rivets are available in a variety of sizes, types, and materials to fit most any application. Simple three step riveting make quick work of most any fastening job. These open end rivets resemble conventional tubular rivets when set, but retain the mandrel within the rivet body for added strength.

Note: All rivets listed are round head rivets.

Code No.	Type	Dia.	Head	Range	Part No.	Price
AD42-A	Aluminum	1/8	1/4	1/16 to 1/8	15-05793	\$0.05
AD43-A	Aluminum	1/8	1/4	1/8 to 3/8	15-05794	\$0.06
AD48-A	Aluminum	1/8	1/4	3/8 to 1/2	15-05795	\$0.18
ADL44-A	Aluminum	1/8	3/8	3/16 to 1/4	15-05797	\$0.09
AD62-A	Aluminum	3/16	3/8	1/16 to 1/8	15-05796	\$0.11
AD66-A	Aluminum	3/16	3/8	1/4 to 3/8	15-05807	\$0.23
AD68-A	Aluminum	3/16	3/8	3/8 to 1/2	15-05808	\$0.15
ADL612-A	Aluminum	3/16	5/8	5/8 to 3/4	15-05809	\$0.35
ADL68-A	Aluminum	3/16	5/8	3/8 to 1/2	15-05810	\$0.39
SD42	Steel	1/8	1/4	1/16 to 1/8	15-05798	\$0.08
SD43	Steel	1/8	1/4	1/8 to 3/16	15-05799	\$0.08
SD48	Steel	1/8	1/4	3/8 to 1/2	15-05800	\$0.14
SDL44	Steel	1/8	3/8	3/16 to 1/4	15-05801	\$0.17
SD62	Steel	3/16	3/8	1/16 to 1/8	15-05811	\$0.21
SD66	Steel	3/16	3/8	1/4 to 3/8	15-05812	\$0.22
SD68	Steel	3/16	3/8	3/8 to 1/2	15-05813	\$0.22
SDL612	Steel	3/16	5/8	5/8 to 3/4	15-05814	\$0.68
SDL68	Steel	3/16	5/8	3/8 to 1/2	15-05815	\$0.19
SSD42-S	Stainless Steel	1/8	1/4	1/16 to 1/8	15-05802	\$0.18
SSD43-S	Stainless Steel	1/8	1/4	1/8 to 3/16	15-05803	\$0.16
SSD48-S	Stainless Steel	1/8	1/4	3/8 to 1/2	15-05804	\$0.38
SSD64-S	Stainless Steel	3/16	3/8	1/8 to 1/4	15-05805	\$0.28
SSD68-S	Stainless Steel	3/16	3/8	3/8 to 1/2	15-05806	\$1.24

RIVET/RIVET NUT BACK MARKER



Used to locate pre-drilled holes in the wing ribs, fuel tank covers, panels, skin. Pre-drill the ribs, screw in the back markers, lay the skin sheet over the top, tap with a hammer, turn the sheet over, and drill the holes. This is especially useful for rivnut installation. Due to the large size of the hole required, small errors in location can lead to the "Oh darn, I missed the rib syndrome". Backmarkers can save you hours of frustration. Two sizes of threaded backmarkers are available. We recommend using the 04-00131 for wing ribs. Drilling the wing ribs with a 3/32" drill. Drop in the back markers. Mark the skin by taping with a soft hammer. Turn the skin over and drill the skin with a 3/32" drill. Cleco the skin into position enlarge the holes with #30 drill & cleco. Now you are ready to rivet.

Nut Plate	Marker Size	Drill Size	Part No.	Price Ea.
10-32	.154	3/8"	04-00124	\$0.98

RIVETS – CHERRYMAX – CHERRYLOCK

SOLID ALUMINUM RIVETS AN426 (MS20426) AN470 (MS20470)



"A" rivets are "soft". They are fabricated from 1100-grade aluminum and have a tensile strength of 16,000 PSI. "AD" rivets are fabricated from 2117 aluminum and heat treated to the T4 condition. They have a shear strength of 26,000 PSI and a tensile strength of 38,000 PSI. All rivets sold in 1/4 lb. & 1/8 lb. packages.

Dash No.	Dia. x L	Price per 1/4 Lb.		Qty Lb.	Price per 1/4 Lb		Qty Lb.
		AN426A	AN426AD		AN470A	AN470AD	
2-5	---	---	---	---	---	\$118.85	---
3-2	3/32 x 1/8	\$26.19	\$17.44	6406	\$20.49	\$17.46	4107
3-3	3/32 x3/16	\$19.24	\$12.98	5003	\$12.49	\$12.49	3485
3-3.5	3/32 X 7/32	---	\$55.75	5618	---	---	---
3-4	3/32 x 1/4	\$14.69	\$16.45	4103	\$11.14	\$11.46	3027
3-5	3/32 x 5/16	\$11.63	\$11.65	3478	\$9.63	\$11.88	2675
3-6	3/32 x 3/8	\$11.88	\$10.38	3018	\$12.44	\$9.88	2397
3-7	3/32 x 7/16	\$10.38	\$10.88	2666	\$8.20	\$10.64	2171
3-8	3/32 x 1/2	\$12.94	\$10.38	2161	\$8.38	\$10.38	1826
3-9	3/32 x 9/16	\$48.50	\$45.50	---	---	\$46.65	---
3-10	3/32 x 5/8	\$12.40	\$8.95	1817	\$8.38	\$7.95	1576
3-12	3/32 x 3/4	\$7.38	\$10.41	1640	\$9.38	\$8.38	1403
3-14	3/32 x 7/8	\$13.69	\$7.88	1567	\$10.13	\$11.63	1386
3-15	3/32 x 5/16	\$16.19	---	1383	---	---	---
3-16	3/32 x 1	\$16.19	---	1378	\$12.13	\$10.63	1237
4-3	1/8 x 3/16	\$12.94	\$10.99	2810	\$10.13	\$8.49	1734
4-4	1/8 x 1/4	\$8.45	\$8.66	2308	\$7.48	\$6.13	1929
4-4.5	1/8 x 9/32	---	---	---	---	\$24.65	1525
4-5	1/8 x 5/16	\$8.88	\$7.49	1958	\$6.88	\$6.98	1367
4-5.5	1/8 X 11/32	---	---	---	---	\$29.50	1674
4-6	1/8 x 3/8	\$8.88	\$7.94	1700	\$5.89	\$7.13	1236
4-7	1/8 x 7/16	\$9.90	\$6.96	1502	\$6.38	\$6.49	1128
4-8	1/8 x 1/2	\$9.63	\$7.38	1346	\$6.41	\$6.88	1037
4-9	1/8 x 9/16	\$8.38	\$5.68	1219	\$6.88	\$7.13	960
4-10	1/8 x 5/8	\$6.96	\$6.49	1025	\$6.46	\$6.13	836
4-11	1/8 x 1	---	---	---	---	\$36.85	---
4-12	1/8 x 3/4	\$7.88	\$6.13	885	\$5.13	\$6.38	740
4-13	1/8 x 13/16	---	\$7.13	797	\$9.90	\$6.66	715
4-14	1/8 x 7/8	\$6.94	\$7.63	631	\$9.63	\$7.13	689
4-15	1/8 x 15/16	---	---	---	---	\$36.55	---
4-16	1/8 x 1	\$7.94	\$9.40	592	\$5.63	\$6.63	594
4-20	1/8 x 1-1/4	\$7.88	\$8.38	467	\$7.48	\$8.49	521
4-22	1/8 x 1-3/8	---	\$7.98	328	\$7.13	\$7.13	496
5-3	5/32 x 3/16	---	\$43.95	1800	---	---	---
5-4	5/32 x 1/4	\$8.63	\$6.96	1440	\$6.18	\$6.24	888
5-5	5/32 x 5/16	\$7.88	\$6.13	1226	\$5.88	\$5.88	850
5-6	5/32 x 3/8	\$8.49	\$5.63	1079	\$5.63	\$5.88	802
5-7	5/32 x 7/16	\$7.13	\$6.44	946	\$4.68	\$5.38	672
5-8	5/32 x 1/2	\$6.69	\$6.63	849	\$5.88	\$5.45	621
5-9	5/32 x 9/16	\$7.90	\$6.13	770	\$6.21	\$5.96	578
5-10	5/32 x 5/8	\$6.13	\$4.91	649	\$4.94	\$5.38	507
5-12	5/32 x 3/4	\$7.89	\$5.95	494	\$6.13	\$6.63	407
5-13	5/32 x .812	---	---	---	---	---	514
5-14	5/32 x 7/8	\$35.70	---	---	---	---	---
5-16	5/32 x 1	\$9.88	\$5.63	450	\$7.88	\$5.39	366
5-22	5/32 x 1-3/8	\$12.38	\$6.88	368	\$10.46	\$9.98	314
6-4	3/16 x 1/4	\$31.50	\$27.50	1134	\$22.50	\$19.70	1134
6-5	3/16 x 5/16	\$6.23	\$6.13	846	\$6.15	\$5.93	515
6-6	3/16 x 3/8	---	---	---	---	\$4.88	---
6-7	3/16 x 7/16	\$5.13	\$5.88	728	\$4.94	\$4.40	436
6-8	3/16 x 1/2	\$23.70	\$16.70	395	\$20.70	\$20.70	395
6-9	3/16 x 9/16	\$24.50	\$19.85	---	\$20.50	\$18.60	354
6-10	3/16 x 5/8	\$6.68	\$4.43	451	\$5.63	\$4.63	334
612	3/16 x 3/4	---	---	---	\$20.90	---	---
6-14	3/16 x 7/8	\$7.63	\$6.38	390	\$5.88	\$5.38	299

10% Discount for 5lbs. of rivets or more (per P/N)

SOLID RIVET ASSORTMENT

"AD" indicates Hard 2117 aluminum alloy. These rivets are heat treated and have a minimum tensile strength of 38,000 PSI. "A" indicates Soft 100 pure aluminum and have a minimum tensile strength of 16,000 PSI. Each kit contains 1/8 lb each of the following 12 sizes: 3/32 (3-4, 3-6, 3-8); 5/32 (5-4, 5-5, 5-6, 5-8); 1/8 (4-4, 4-6, 4-8); 3/16 (6-6, 6-8)

Pack C..... AN470AD, Universal Hard.....P/N 04-00357\$44.00
 Pack D..... AN470A, Universal Soft.....P/N 04-00358\$44.53
 Pack E..... AN426AD, 100° CSK Hard.....P/N 04-00359\$50.25
 Pack F..... AN426A, 100° CSK Soft.....P/N 04-00361\$58.00

SEAT RAIL RIVET KIT - Contains AN470AD rivets for installation of 2 seat rails in Cessna 177.....P/N 01-01361\$35.50

CHERRYMAX RIVETS



Due to the large bulbed blind head, similar to that of a solid rivet, the Cherrylock and CherryMax rivets are especially suited for double dimpled or high vibration applications. They can be used as replacements for some solid rivets and are excellent for use in fiberglass or composites as the rivet spreads in a way that prevents crazing or cracking of the material. **Note:** CR3212 & CR3213 are nominal diameters. CR3242 & CR3243 are oversized diameters and measure 1/64" more than listed diameter. Install with P/N 12-03105 G-27 Hand Gun.

Dash #	Dia.	CR3212 Grip Range	CR3213 Grip Range	Each	Price 100
4-1		---	.025-.062	---	---
4-2	.126	.063-.125	.063-.125	\$0.70	\$63.00
4-3		.126-.187	.126-.187	\$0.60	\$54.00
4-4		.188-.250	.188-.250	\$0.56	\$50.40
4-5		.251-.312	.251-.312	\$0.66	\$59.40
4-6		.313-.375	.313-.375	\$0.68	\$61.20
4-9		.501-.582	---	---	\$282.95
5-2	.157	.065-.125	.063-.125	\$0.71	\$63.90
5-3		.126-.187	.126-.187	\$0.68	\$61.20
5-4		.188-.250	.188-.250	\$0.86	\$77.40
5-5		.251-.312	.251-.312	\$0.97	\$87.30
5-6		.313-.375	.313-.375	\$0.85	\$76.50
6-10		.189	.563-.625	.563-.625	\$2.75

Dash #	Dia.	CR3242 Grip Range	CR3243 Grip Range	Each	Price 100
4-1	.140	.032-.063	.025-.062	\$0.77	\$69.30
4-2		.063-.125	.063-.125	\$0.71	\$63.90
4-3		.126-.187	.126-.187	\$0.64	\$57.60
4-4		.188-.250	.188-.250	\$0.69	\$62.10
4-5		.251-.312	.251-.312	\$0.91	\$81.90
4-6	.313-.375	.313-.375	\$1.03	\$92.70	
5-2	.173	.063-.125	.063-.125	\$0.84	\$75.60
5-3		.126-.187	.126-.187	\$0.92	\$82.80
5-4		.188-.250	.188-.250	\$0.89	\$80.10
5-5		.251-.312	.251-.312	\$0.86	\$77.40
5-6		.313-.375	.313-.375	\$0.94	\$84.60
6-6		.187	---	.313-.375	\$1.10

NOTE: SUBJECT TO PRICE AND AVAILABILITY OF CHERRY BRAND RIVETS. EQUIVALENT RIVETS MAY BE FURNISHED.

CHERRYMAX GRIP GAUGE



Measures rivet diameter and length.
 P/N 12-00217\$14.50

ZENAIR BLIND RIVETS

The Zenith blind rivets are made from quality alloys, and are batch tested by Zenith Aircraft Company for shear strength before being shipped. These rivets are corrosion resistant, and the stem becomes locked in after being set. Also, not many different lengths are required for different diameters or thicknesses. In the Assembly Instructions, they are designated as A4 (1/8) and A5 (5/32). See Tools Section for Zenair Riveters.

Zenair Blind Rivet 1/8".....P/N 12-05538\$0.14
 Zenair Blind Rivet 5/32".....P/N 12-05539\$0.20
 Domed Head Blind Rivets 3/16".....P/N 12-05540\$0.42
 Blind Rivets Domed Head Rivet 3/32".....P/N 12-05541\$0.20
 Stainless Steel Rivet 3-5mm Grip 5/32".....P/N 12-05542\$0.39

OVERSIZE AND HALF SIZE RIVETS

HALF-SIZE LENGTH RIVETS - These flush head AN426 rivets are ideal for those situations where one length is just too short & the next length is too long.

Part No.	Dia.	Length	Price Per 1/8 lb.
AN426AD-3-3.5	3/32"	7/32"	\$55.75
AN426AD-3-4.5	3/32"	9/32"	\$59.95
AN426AD-3-5.5	3/32"	11/32"	\$44.65

OVERSIZE SHANK RIVETS - These NAS1097 rivets feature a 1/8" diameter shank with a head size that of a 3/32" rivet. Perfect when rivet hole becomes enlarged requiring 1/8" shank but 3/32" head matches rest of your 3/32" rivets.

Part No.	Dia.	Length	Price Per 1/8 lb.
NAS1097AD-4-3.5	1/8"	7/32"	\$46.50
NAS1097AD-4-4	1/8"	1/4"	\$32.60
NAS1097AD-4-5	1/8"	5/16"	\$36.50
NAS1097AD-4-6	1/8"	3/8"	\$32.50

NUTSERTS



The A-T Series Insert is unique in that it can be installed into most any material above .030/.76 mm in thickness. As the A-T Series is installed, the threaded portion is completely swaged 360° into the sleeve portion and the hole. This permits the A-T Series to be used with Grade 8/metric 12.9 mating screws. The A-T Series Insert is installed using lightweight, hand held pneumatic tools that can be located at any position in your product's assembly sequence. The A-T Series Insert can be installed either prior to or after finish.

360° SWAGING HOW IT WORKS FOR YOU

As the A-T Series Insert is installed, the threaded nut portion is drawn into the upper sleeve portion.



As this occurs, a 360° swaging action takes place anchoring the A-T Series in the parent material.

NUTSERT HOLE SIZE / MATERIAL THICKNESS CHART

Installation hole size for the A-T Series Insert is determined by the parent material's thickness and density. The thicker the material the larger the hole required to allow full 360° installation swaging. The application should be tested before hole size is specified.

THREAD SIZE	.030-.090 MAT. THICKNESS		.091-.124 MAT THICKNESS		.125-.186 MAT. THICKNESS		.187-OVER MAT. THICKNESS	
	DRILL SIZE	DECIMAL	DRILL SIZE	DECIMAL	DRILL SIZE	DECIMAL	DRILL SIZE	DECIMAL
4-40 UNC	3/16	.1875	#10	.1935	#10	.1935	#9	.1960
6-32 UNC	7/32	.2188	#2	.2210	#1	.2280	#1	.2280
8-32 UNC	1/4	.2500	"F"	.2570	17/64	.2656	17/64	.2656
10-24 UNC	9/32	.2812	"L"	.2900	"L"	.2900	19/64	.2969
10-32 UNF	9/32	.2812	"L"	.2900	"L"	.2900	19/64	.2969
1/4-20 UNC	3/8	.3750	3/8	.3750	"W"	.3860	25/64	.3906
1/4-28 UNC	3/8	.3750	3/8	.3750	"W"	.3860	25/64	.3906
5/16-18 UNC	1/2	.5000	1/2	.5000	33/64	.5156	33/64	.5156
5/16-24 UNC	1/2	.5000	1/2	.5000	33/64	.5156	33/64	.5156
3/8-16 UNC	9/16	.5625	9/16	.5625	37/64	.5781	37/64	.5781
1/2-13 UNC	3/4	.7500	49/64	.7656	25/32	.7810	51/64	.7970

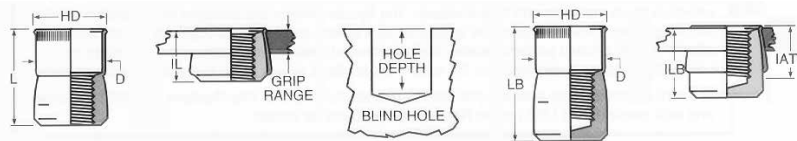

Thread Size	Thread Call Out	HD ±.005	L ±.015	D MAX.	IL MAX.	LB ±.015	ILB MAX.	IATD** MAX.	Hole Depth Min.	Part No.	Price Each
4-40 UNC	440	.211	.370	.1875	.205	.660	.495	.395	.400	ATS2-440	\$0.29
6-32 UNC	632	.240	.370	.2185	.205	.675	.505	.410	.400	ATS2-632	\$0.34
8-32 UNC	832	.269	.370	.2495	.205	.675	.505	.410	.400	ATS2-832	\$0.28
10-24 UNC	1024	.306	.370	.2805	.205	.685	.520	.385	.400	ATS2-1024	\$0.35
10-32 UNF	1032	.306	.370	.2805	.205	.685	.520	.385	.400	ATS2-1032	\$0.34
1/4-20 UNC	420	.400	.515	.3745	.275	1.005	.760	.615	.540	ATS2-420	\$0.60
1/4-28 UNC	420	.400	.515	.3745	.275	1.005	.760	.615	.540	ATS2-428	\$0.59
5/16-18 UNC	518	.528	.615	.4995	.325	1.065	.770	.630	.640	ATS2-518	\$0.85
5/16-24 UNC	518	.528	.615	.4995	.325	1.065	.770	.630	.640	ATS2-524	\$1.20
3/8-16 UNC	616	.588	.745	.5615	.390	1.450	1.095	.890	.770	ATS2-616	\$1.69
1/2-13 UNC	813	.800	.935	.7485	.485	NA	NA	NA	.960	ATS2-813	\$4.45

**Dimensions in minimum grip condition. Additional UNF thread sizes available.

AA-112 HI-TORQUE NUTSERT TOOL



The hi-torquer tool is ideal for field and maintenance applications. It features a patented Quick Change thread size nose assembly.

Order one base tool plus appropriate conversion kit. No warranty on these tools.

Thread Size	Conv. Kit Part No.	Price Each
4-40 UNC	AAT-202-440	\$31.75
6-32 UNC	AAT-202-632	\$31.70
8-32 UNC	AAT-202-832	\$31.75
10-24 UNC	AAT-202-1024	\$31.75
10-32 UNF	AAT-202-1032	\$32.70
1/4-20 UNC	AAT-202-420	\$32.70
1/4-28 UNC	AAT-202-428	\$31.75
5/16-18 UNC	AAT-202-518	\$31.75
5/16-24 UNC	AAT-202-524	\$31.75
3/8-16 UNC	AAT-202-616	\$31.75
Base tool, P/N AA-112.....		\$69.50

AAT916 EXPENDABLE NUTSERT TOOLS



These expendable tools are ideal for applications such as field repair. They

can also be packaged with instructions for use along with quantity of inserts for consumer assembly. Sizes 6-32, 8-32 include a hex key. Sizes 10-32, and larger require a wrench (not included). No warranty on these tools.

THREAD SIZE	TOOL PART NUMBER	Price Each
4-40 UNC	AAT-916-440	\$12.70
6-32 UNC	AAT-916-632	\$15.60
8-32 UNC	AAT-916-832	\$15.50
10-24 UNC	AAT-916-1024	\$9.50
10-32 UNF	AAT-916-1032	\$15.50
1/4-20 UNC	AAT-916-420	\$13.50
1/4-28 UNC	AAT-916-428	\$9.85
5/16-18 UNC	AAT-916-518	\$9.50
5/16-24 UNC	AAT-916-524	\$14.50
1/2-13 UNC	AAT-916-813	\$83.75
3/8-16 UNC	AAT-916-616	---

AAT312A MASTER NUTSERT ASSORTMENT KIT



The A-T Series master assortment kit is ideal for prototype and maintenance repair applications. The rugged hard shell plastic kit contains quantities of the A-T Series Inserts and the AA 112 Hi-torquer tool. It also contains a full compliment of thread size conversion kits and instruction label. No warranty on these tools.

KIT CONTAINS:

Thread Size	Qty.	Nutsert Part No.	Conv. Kit
4-40 UNC	50	ATS2-440	AAT-202-440
6-32 UNC	50	ATS2-632	AAT-202-632
8-32 UNC	50	ATS2-832	AAT-202-832
10-32 UNF	50	ATS2-1032	AAT-202-1032
1/4-20 UNC	50	ATS2-420	AAT-202-420
5/16-18 UNC	50	ATS2-518	AAT-202-518
Kit, P/N AAT312A.....			\$246.95

Nutsert available. Sold Each.

DZUS® FASTENERS

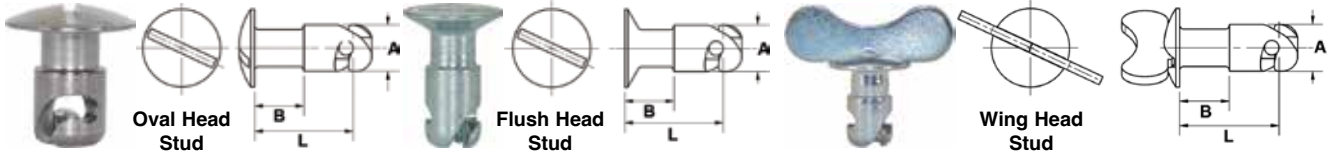

OVAL HEAD STUD, LONG UNDERCUT

Model No.	Stud Dimensions			Zinc Electroplated		Model No.	Stainless		Grommets & Snap Rings	Springs
	A	B	L	Cat. #	Price Each		Cat. #	Price Each		
121J-325-Z3C	.1875	.075	.250	AJ3-25*	\$4.35	-	-	-	GA3-175, 200, 250 GP3B, GH3 SR3SS SX-520SS	S3-150, 175 200, 225
121J-330-Z3C	.1875	.100	.300	AJ3-30	\$2.65	-	-	-		
121J-335-Z3C	.1875	.150	.350	AJ3-35*	\$2.45	121J-335-SS	AJ3-35SS*	\$5.35		
121J-340-Z3C	.1875	.200	.400	AJ3-40	\$2.39	-	-	-	GA4-225, 250, 275, 300 GP4B, GH4 SB4SS SX-523SS	S4-200, 225
121J-425-Z3C	.250	.100	.250	AJ4-25*	\$2.22	121J-425-SS	AJ4-25SS*	\$14.50		
121J-430-Z3C	.250	.100	.300	AJ4-30	\$1.95	121J-430-SS	AJ4-30SS	\$8.50		
121J-435-Z3C	.250	.150	.350	AJ4-35*	\$2.20	121J-435-SS	AJ4-35SS*	\$5.45		
121J-440-Z3C	.250	.200	.400	AJ4-40	\$2.65	121J-440-SS	AJ4-40SS	\$4.35		
121J-445-Z3C	.250	.225	.450	AJ4-45*	\$18.50	-	-	-		
121J-450-Z3C	.250	.250	.500	AJ4-50	\$2.55	-	-	-		
121J-530-Z3C	.3125	.125	.300	AJ5-30	\$2.65	121J-530-SS	AJ5-30SS	\$4.50		
121J-535-Z3C	.3125	.125	.350	AJ5-35*	\$2.80	121J-535-SS	AJ5-35SS*	\$3.80		
121J-540-Z3C	.3125	.190	.400	AJ5-40	\$2.25	121J-540-SS	AJ5-40SS	\$3.85		
121J-545-Z3C	.3125	.190	.450	AJ5-45*	\$2.80	-	-	-	GA5-312, 350, 375 GP5B, GH5 SR5SS SX-510SS	S5A200, 225 250, 275
121J-550-Z3C	.3125	.250	.500	AJ5-50	\$2.65	-	-	-		
121J-560-Z3C	.3125	.300	.600	AJ5-60	\$2.59	-	-	-		
121J-570-Z3C	.3125	.400	.700	AJ5-70	\$5.55	-	-	-		
121J-635-Z3C	.375	.150	.350	AJ6-35*	\$2.88	-	-	-		
121J-640-Z3C	.375	.190	.400	AJ6-40	\$2.54	-	-	-		
121J-650-Z3C	.375	.250	.500	AJ6-50	\$2.63	-	-	-		
121J-660-Z3C	.375	.300	.600	AJ6-60	\$2.37	-	-	-		
121J-670-Z3C	.375	.350	.700	AJ6-70	\$2.49	-	-	-		
121J-740-Z3C	.4375	.190	.400	AJ7-40	-	-	-	-		
121J-750-Z3C	.4375	.250	.500	AJ7-50	\$1.60	-	-	-	GA7-375, 475, 525 GH7 SR7SS, SX-519SS	S7-225, 250, 275, 300
121J-770-Z3C	.4375	.350	.700	AJ7-70	\$6.55	-	-	-		

FLUSH HEAD STUD, LONG UNDERCUT

Model No.	Stud Dimensions			Zinc Electroplated		Model No.	Stainless		Grommets & Snap Rings	Springs		
	A	B	L	Cat. #	Price Each		Cat. #	Price Each				
126J-330-Z3C	.1875	.150	.300	FJ3-30	\$5.35	-	-	-	GP3B-GH3 SR3SS SX-520SS	S3-150, 175, 200, 225		
126J-335-Z3C	.1875	.175	.350	FJ3-35*	-	-	-	-				
126J-340-Z3C	.1875	.200	.400	FJ3-40	\$6.50	-	-	-				
-	.250	.150	.300	-	-	126J-430-SS	FJ4-30SS	\$4.50	GF4-125, 150, 175, 200 GP4B, GH4 SR4SS SX-523SS	S4-200, 225		
126J-435-Z3C	.250	.175	.350	FJ4-35*	\$2.20	126J-435-SS	FJ4-35SS1	\$5.60				
126J-440-Z3C	.250	.200	.400	FJ4-40	-	126J-440-SS	FJ4-40SS	\$11.50				
126J-445-Z3C	.250	.225	.450	FJ4-45*	\$1.22	126J-445-SS	FJ4-45SS1	\$9.80				
126J-450-Z3C	.250	.250	.500	FJ4-50	\$1.95	-	-	-				
126J-540-Z3C	.3125	.225	.400	FJ5-40	\$4.35	126J-540-SS	FJ5-40SS	\$5.80				
126J-550-Z3C	.3125	.250	.500	FJ5-50	\$1.90	-	-	-			GF5-175, 225, 250 GP5B, GH5 SR5SS, SX-510SS	S5A200, 225 250, 275
126J-560-Z3C	.3125	.300	.600	FJ5-60	\$14.80	-	-	-				
126J-650-Z3C	.375	.250	.500	FJ6-50	\$2.84	-	-	-			GF6-218, 250 GP6B, GH6 SR6SS, SX-518SS	S6-225, 250, 275 300
126J-660-Z3C	.375	.300	.600	FJ6-60	\$4.85	-	-	-				
126J-670-Z3C	.375	.350	.700	FJ6-70	\$18.00	-	-	-				
126J-750-Z3C	.4375	.250	.500	FJ7-50	\$1.65	-	-	-	GF7-250, 325, 400 GH7, SR7SS, SX-519SS	S7-225, 250, 275, 300		
126J-770-Z3C	.4375	.350	.700	FJ7-70	-	-	-	-				

WING HEAD STUD, LONG UNDERCUT

(A, B, L dimensions for AJW are same as for AJ; P, Q, R dimensions given are for wing head)

Model No.	Stud Dimensions			Zinc Electroplated		Model No.	Stainless		Grommets & Snap Rings	Springs		
	A	B	L	Cat. #	Price Each		Cat. #	Price Each				
121J-W325-Z3C	.1875	.075	.250	AJW3-25*	-	-	AJW3-25SS*	-	GA3-175, 200, 250 GP3B, GH3 SR3SS SX-520SS	S3-150, 175 200, 225		
121J-W330-Z3C	.1875	.100	.300	AJW3-30	\$5.35	-	-	-				
121J-W335-Z3C	.1875	.150	.350	AJW3-35*	\$5.70	-	-	-				
121J-W340-Z3C	.1875	.200	.400	AJW3-40	\$2.51	-	-	-	GA4-225, 250, 275, 300 GP4B, GH4 SR4SS SX-523SS	S4-200, 225		
121J-W425-Z3C	.250	.100	.250	AJW4-25*	\$2.48	-	-	-				
121J-W430-Z3C	.250	.100	.300	AJW4-30	\$3.55	-	-	-				
121J-W435-Z3C	.250	.150	.350	AJW4-35*	\$4.35	-	-	-				
121J-W440-Z3C	.250	.200	.400	AJW4-40	\$2.60	-	-	-				
121J-W530-Z3C	.3125	.125	.300	AJW5-30	\$6.50	-	-	-				
121J-W540-Z3C	.3125	.190	.400	AJW5-40	\$2.95	-	-	-				
121J-W545-Z3C	.3125	.200	.450	AJW5-45*	\$4.60	-	-	-				
121J-W550-Z3C	.3125	.250	.500	AJW5-50	\$3.35	-	-	-			GA5-312, 350, 375 SR5SS SX-510SS	S5A200, 225
-	-	-	-	-	-	-	-	-				

CAD PLATED FASTENERS ARE NO LONGER AVAILABLE DUE TO ENVIRONMENTAL REASONS.

*No longer available after our current stock is depleted. Please order next longer size.

DZUS® FASTENERS

STUD AND SPRING SELECTION TABLES

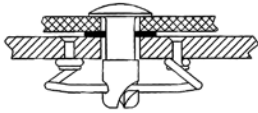

1. Find total thickness (distance) from underside of stud head to point of spring attachment).
2. Select stud "L" and spring "H" dims.

Size 3 Stud, S3 Spring			Size 4 Stud, S4 Spring		
Use			Use		
Total Thickness	Stud Dim. L	Spring Dim. H	Total Thickness	Stud Dim. L	Spring Dim. H
.045 - .069	-25	-225	.050 - .074	-25	-225
.070 - .094	-25	-200	.075 - .099	-25	-200
.095 - .119	-30	-225	.100 - .124	-30	-225
.120 - .144	-30	-200	.125 - .149	-30	-200
.145 - .169	-30	-175	.150 - .174	-35	-225
.170 - .194	-30	-150	.175 - .199	-35	-200
.195 - .219	-35	-175	.200 - .224	-40	-225
.220 - .224	-35	-150	.225 - .249	-40	-200
.245 - .269	-40	-175	.250 - .274	-45	-225
.270 - .294	-40	-150	.275 - .299	-45	-200
			.300 - .324	-50	-225
			.325 - .344	-50	-200

Size 5 Stud, S5A Spring			Size 6 Stud, S6 Spring Size 7 Stud, S7 Spring		
Use			Use		
Total Thickness	Stud Dim. L	Spring Dim. H	Total Thickness	Stud Dim. L	Spring Dim. H
.055 - .079	-30	-275	.090 - .114	-35	-300
.080 - .104	-30	-250	.115 - .139	-35	-275
.105 - .129	-30	-225	.140 - .164	-35	-300
.130 - .154	-30	-200	.165 - .189	-40	-275
.155 - .179	-40	-275	.190 - .214	-40	-250
.180 - .204	-40	-250	.215 - .239	-40	-225
.205 - .229	-40	-225	.240 - .264	-50	-300
.230 - .254	-40	-200	.225 - .249	-40	-200
.255 - .279	-50	-275	.265 - .289	-50	-275
.280 - .304	-50	-250	.290 - .314	-50	-250
.305 - .329	-50	-225	.315 - .339	-50	-225
.330 - .354	-50	-200	.340 - .364	-60	-300
.355 - .379	-60	-275	.365 - .389	-60	-275
.380 - .404	-60	-250	.390 - .414	-60	-250
.405 - .429	-60	-225	.415 - .439	-60	-225
.430 - .454	-60	-200	.440 - .464	-70	-300
.455 - .479	-70	-275	.465 - .489	-70	-275
.480 - .504	-70	-250	.490 - .514	-70	-250
.505 - .529	-70	-255	.515 - .539	-70	-225
.530 - .554	-70	-200			



SPRINGS

Model No.	Part No.	Price Ea.	Model No.	Part No.	Price Ea.
1219-3150-Z3CT	S3-150	\$2.01	1219-5300-Z3Y	S5A-300	\$2.25
1219-3175-Z3Y	S3-175	\$2.10	1219-6225-Z3Y	S6A-225	\$2.57
1219-3200-Z3Y	S3-200	\$3.70	1219-6250-Z3Y	S6A-250	\$3.35
1219-3225-Z3Y	S3-225	\$3.35	1219-6275-Z3Y	S6A-275	\$4.35
1219-4220-Z3Y	S4-200	---	1219-6300-Z3Y	S6-300	\$3.95
1219-4225-Z3Y	S4-225	\$1.35	1219-6400-Z3Y	S6A-400	\$7.75
1219-4250-Z3Y	S4-250	\$1.15	1219-6425-Z3Y	S6A-425	\$3.35
1219-A4200-Z3Y	S4A-200	\$1.35	1219-6325-Z3Y	S5A-325	\$2.28
	S5-325-SURP	\$0.75	1219-7250-Z3Y	S7-250	\$6.50
1219-A5200-Z3Y	S5A-200	\$1.40			
1219-A5225-Z3Y	S5A-225	\$1.95			
1219-A5250-Z3Y	S5A-250	\$1.25			
1219-A5275-Z3Y	S5A-275	\$1.75			

The dash number represents the height ("H" dimension) of the spring.

RETAINING SPRINGS



When there is a gap between the top and bottom panels, a retaining spring is used to hold the stud in locking position for alignment with receptacle.

Model No.	Part No.	Price ea
1219-24520-SS	SX-520SS	\$0.14
1219-24523-SS	SX-523SS	\$0.56
1219-24510-SS	SX-510SS	\$0.71
1219-24518-SS	SX-518SS	\$0.14

SNAP RINGS



A snap ring is used when there is not a lot of pull-out load. This ring is expandable easily installed with pliers or screwdriver and takes little space.

Model No.	Part No.	Price ea
1219-R3-SS	SR3SS	\$0.45
1219-R4-SS	SR4SS	\$0.40
1219-R5-SS	SR5SS	\$0.30
1219-R6-SS	SR6SS	\$0.35
1219-R7-SS	SR7SS	\$0.58

FULL GROMMETS



A full grommet is used when protection of the hole is a definite consideration. It protects panel finish and reduces stud play. A tool is required for installation. The "GA" type full grommet is used with a protruding head stud, and the "GF" type with a flush head stud.

ALUMINUM

Outer Panel Thickness	Type "GA"			Type "GF"		
	Model No.	Part No.	Price	Model No.	Part No.	Price
.015 - .025	1271-3175	GA3-175	\$6.50	---	N/A	---
.026 - .050	1271-200	GA3-200	\$2.60	---	N/A	---
.051 - .094	1271-250	GA3-250	\$1.79	---	N/A	---
.015 - .025	---	GA4-225	--	1276-4125	GF4-125	\$5.35
.026 - .050	1271-4250	GA4-250	\$1.95	1276-4150	GF4-150	\$14.75
.051 - .075	1271-4275	GA4-275	\$1.92	1276-4175	GF4-175	\$6.50
.076 - .100	1271-4300	GA4-300	\$7.70	1276-4200	GF4-200	\$8.80
.031 - .062	1271-5312	GA5-312	\$1.80	1276-5175	GF5-175	\$1.35
.063 - .094	1271-5350	GA5-350	\$2.80	1276-5225	GF5-225	\$2.45
.095 - .125	1271-5375	GA5-375	\$2.75	1276-5250	GF5-250	\$5.45
.040 - .065	1271-6350	GA6-350	\$3.35	---	GF6-218	---
.066 - .100	1271-6375	GA6-375	\$4.35	1276-6250	GF6-250	\$2.38
.101 - .135	1271-6425	GA6-425	\$3.75	---	---	---
.050 - .095	1271-7375	GA7-375	\$5.35	1276-7250	GF7-250	\$5.35
.096 - .156	---	GA7-475	---	---	GF7-325	---
.157 - .218	1271-7525	GA7-525	---	1276-7400	GF7-400	---

HALF GROMMETS



A half grommet does not break easily, and it flattens but guarantees hold of the stud. It is used when protection of the hole is not a consideration, but protection of panel finish might be. The "GH" type half grommet is installed with a tool; the "GP" type is pushed on by hand.

Type "GP" Thermoplastic			Type "GH" Aluminum		
Model No.	Part No.	Price ea	Model No.	Part No.	Price ea
127P-3B	GP3B	\$0.29	127H-3	GH3	\$0.45
127P-4B	GP4B	\$0.20	127H-4	GH4	---
127P-5B	GP5B	\$0.25	127H-5	GH5	\$0.65
127P-6B	GP6B	\$0.48	127H-6	GH6	\$0.60
127P-7B	GP7B	---	127H-7	GH7	\$1.47

CAMLOC FASTENERS

The 2600 and 2700 series Camloc fasteners exceed requirements for MIL-F-5591, Style 3, Size 2. Shear and tensile strength: 300 lbs. (ultimate), 200 lbs. (rated). Studs and washers listed are made of steel. The receptacles are made of copper base alloy. All components listed are rated to 450° F. The 4002 series fasteners are considerably stronger than the 2600 and 2700 series. Shear and tensile strength: 1050 lbs. (ultimate), 700 lbs. (rated). All studs and grommets listed are made of steel. Rated to 450° F.

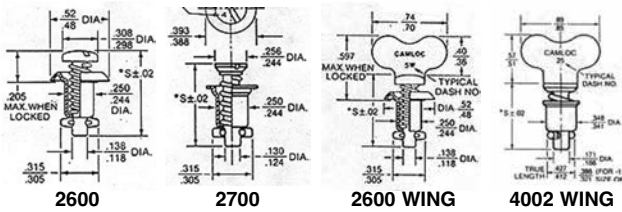

2600 SERIES STUDS

Dash No.	CAD Plated		Stainless		CAD Plated	
	2600 Slot Price Ea	26S8 Phillips Price Ea	Dash No.	2600 Slot Price Ea	Wing CAD Plated	Price Each
-1	\$6.60	\$9.50	-1S	\$11.50	---	---
-2	\$6.90	\$2.90	-2S	\$8.50	2600-2W	\$36.85
-3	\$5.40	\$2.45	-3S	\$7.70	2600-3W	\$19.90
-4	\$3.55	---	-4S	\$4.35	2600-4W	\$19.65
-5	\$5.85	---	-5S	\$5.35	2600-5W	\$19.80
-6	\$4.50	---	-6S	\$11.95	2600-6W	\$17.50
-7	\$13.80	---	-7S	---	2600-7W	---
-8	\$4.45	---	-8S	\$3.35	2600-8W	\$59.75
-9	\$11.65	---	-9S	---	2600-9W	\$23.50
-10	\$7.95	---	-10S	---	2600-10W	\$22.60
-11	\$11.95	---	---	---	2600-11W	---
-12	\$7.90	---	---	---	2600-12W	\$21.70
-13	\$8.95	---	---	---	---	---
-14	---	---	---	---	2600-14W	---

2700 SERIES STUDS

Dash No.	CAD Plated		Stainless	
	2700 Slot Price Ea	27S3 Phillips Price Ea	Dash No.	2700 Slot Price Ea
-1	\$13.50	\$12.75	-1S	\$6.55
-2	\$10.70	\$6.65	-2S	\$5.35
-3	\$11.50	\$7.50	-3S	\$13.75
-4	\$7.60	\$8.50	-4S	\$6.90
-5	\$11.80	\$7.55	-5S	\$7.95
-6	\$8.50	\$12.50	-6S	\$8.55
-7	\$9.65	\$17.65	-7S	\$6.50
-8	\$7.75	\$13.65	-8S	\$7.50
-9	\$10.95	\$9.85	-9S	---
-10	---	\$11.45	-10S	---
-11	\$7.35	---	-11S	---
-12	---	\$11.50	-12S	\$13.90
-13	---	\$17.95	-13S	---
-14	---	---	---	---

4002 SERIES STUDS

Dash No.	CAD Plated / Stainless							
	4002 CAD Plated Slot Price Ea	40S5 CAD Plated Phillips Price Ea	SS Phillips 40S5 Price Each	Dash No.	4002 SS Slot Price Ea	Wing CAD Plated	Price Each	
-2	\$11.50	\$5.55	40S5-2S	\$17.50	-2S	\$15.70	4002-2W	---
-3	\$5.35	\$4.35	40S5-3S	\$4.65	-3S	\$38.50	4002-3W	---
-4	\$7.90	\$14.95	40S5-4S	\$6.50	-4S	\$8.75	4002-4W	---
-5	\$3.25	\$6.90	40S5-5S	\$2.95	-5S	\$11.85	4002-5W	\$20.75
-6	\$9.50	\$13.70	40S5-6S	\$6.50	-6S	\$11.95	4002-6W	\$19.85
-7	\$2.75	\$9.50	40S5-7S	\$5.35	-7S	\$22.85	---	---
-8	\$9.50	\$6.50	40S5-8S	\$6.35	-8S	\$7.50	4002-8W	\$21.75
-9	\$4.35	\$13.45	40S5-9S	\$11.60	-9S	\$20.65	4002-9W	\$37.50
-10	\$8.95	---	40S5-10S	\$13.50	---	---	4002-10W	---
-11	\$8.60	---	---	---	---	---	4002-11W	---
-12	\$7.90	---	---	---	---	---	4002-12W	---
-13	---	---	---	---	---	---	---	---
-14	\$12.70	\$9.50	---	---	---	---	---	---
-15	\$7.50	\$9.50	---	---	---	---	---	---
-16	\$31.75	---	---	---	---	---	---	---
-17	\$22.50	---	---	---	---	---	---	---

RECEPTACLES

2600 Series - Small enough to fit in limited mounting space and light weight. All of these fasteners have a 600# ultimate tensile load capacity. 4200 Series - The Modern Standard in Quick Release Fastening Systems. They have an 800# working strength and 1050# Ultimate Tensile load capacity.



Rivet Holes	2600, 2700 Series Part No.	Price Each	4002 Series Part No.	Price Each
Plain	212-12N	\$3.65	214-16N	\$5.40
Countersunk	212-12ND*	\$5.35	214-16ND*	\$8.90
Plain	Floating Bronze	---	244-16	\$8.90

2600 / 2700 SERIES STUD LENGTH SELECTION

Total material thickness "G" consists of the thickness of all materials to be fastened. This must include the thickness of the material "P" to which the stud assembly is attached, the material "F" to which the receptacle is attached plus gaskets (if used) and allowance for paint or other protective finishes. If the total thickness is near the upper limit of the stud grip range, the next longer stud should be used. This will still maintain positive locking of the fastener under vibration.

P (panel thickness)062
F (frame thickness) + .062
GRIP (total thickness) = .124

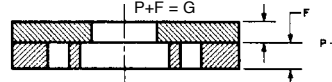

STUD SELECTION TABLE Using 212-12 Receptacle

Total Grip Thickness	Use 2600	Use 2700
.020 - .059	2600-1	2700-1
.060 - .089	2600-2	2700-2
.090 - .119	2600-3	2700-3
.120 - .149	2600-4	2700-4
.150 - .179	2600-5	2700-5
.180 - .209	2600-6	2700-6
.210 - .239	2600-7	2700-7
.240 - .269	2600-8	2700-8
.270 - .299	2600-9	2700-9
.300 - .329	2600-10	2700-10
.330 - .359	2600-11	2700-11
.360 - .389	2600-12	2700-12
.390 - .419	2600-13	2700-13
.420 - .449	2600-14	2700-14

4002 SERIES (LARGE HEAD) STUD SELECTION

To select the proper length stud, first select the grommet, for example 4002-G. Next, select the receptacle, such as 214-16. After determining the total grip thickness, use the grommet column under which the selected grommet and receptacle appear. Use the dash number which appears opposite the determined total grip thickness.

Example: If the total determined grip thickness "G" was .144, the stud dash number for the above 4002-G grommet and 214-16 receptacle would be -4. The stud part number would be 4002-4.

Total Grip Thickness Range "G"	Stud Dash Number	
	4002-G Grommet & 214-16 Receptacle	4002-N, 4002-O Grommet & 214-16 Receptacle
.021 - .050	--*	-1
.055 - .080	--*	-2
.081 - .110	-2*	-3
.111 - .140	-3	-4
.141 - .170	-4	-5
.171 - .200	-5	-6
.201 - .230	-6	-7
.231 - .260	-7	-8
.261 - .290	-8	-9
.291 - .320	-9	-10
.321 - .350	-10	-11
.351 - .380	-11	-12
.381 - .410	-12	-13
.411 - .440	-13	-14
.441 - .470	-14	-15
.471 - .500	-15	-16
.501 - .530	-16	-17
.531 - .560	-17	-

*4002-G grommet requires .090" minimum grip.

2600, 2700 SERIES RETAINING WASHERS

Retaining washers are required for studs of -5 length or greater. Use split washer 2600-SW2 where it is desirable to have the stud fall away for minimum internal projection. Use internal tooth washer 2600-LW where it is desirable to retain the stud assembly rigidly.

P/N 2600-SW-2 \$2.45 P/N 2600-LW \$0.95

4002 SERIES GROMMETS & SNAP RINGS

Description	Part No.	Price
CAD Plated		
Flush Grommet	4002-G	\$1.40
Flush Grommet	4002-H	\$4.45
Plus-Flush Grommet	4002-N	\$2.30
Stud Retaining Grommet	4002-O	\$3.50
High Shear Flush Grommet	40G1-5	\$4.95
Wide Area Grommet	4002-N3	\$5.35
Grommet Retaining Ring	R4G	\$1.25
Camloc Retaining Ring	4002-SW	\$2.75
High Shear Grommet Retaining Ring	R4T	\$5.70
Stainless		
High Shear Grommet Retaining Ring	40G26-1	\$2.60
Flush Grommet	4002-GS	\$3.65
Flush Grommet	4002-HS	\$6.50
Plus Flush Grommet	4002-NS	\$6.50
Flush Grommet	4002-OS	\$4.60



SKYBOLT CAMLOC RETAINING RING SK-R4T

4000 Series Heavy Duty Grommet Retainer. Superior Quality Panel Fastener Manufacturing since 1982. U.S. Manufacturer & Distributor of the highest grade stainless steel 1/4-Turn Panel Fasteners, Grommets & Receptacles, and many other innovative fastening solutions..... P/N 04-04194 \$0.70

CAMLOC FASTENERS – COWLING KITS

COWLING KITS

Aircraft Make & Model	Stainless				Cad-Plated Phillips	
	Slotted		Phillips		Part Number	Price
	Part Number	Price	Part Number	Price		
Aerosport			04-00327 ^A	\$55.00		
Aero Commander 690	04-00286 ^B	\$4,885.00			04-00336 ^B	\$3,414.00
Aerostar	04-00287 ^B	\$4,475.00			04-00337 ^B	\$1,337.00
Beech Baron B55 ('69 SN TC1230) ^A	04-00288 ^B	\$1,702.00	04-00329 ^B	\$902.00		
Beech Baron B58	04-00289 ^B	\$959.00			04-00338 ^B	\$330.95
Beech Baron P58	04-00291 ^B	\$1,588.00				
Bellanca Scout 8GCBC	04-00292 ^A	\$82.75				
Bellanca Viking	04-00293 ^B	\$692.00			04-00339 ^B	\$295.95
Cessna 150 (1967-77)	04-00294 ^A	\$77.75	04-00331 ^A	\$72.50		
Cessna 172 (1967-82)	04-00297 ^A	\$84.00	04-00332 ^A	\$87.50		
Cessna 172RG (1984)	04-00298 ^B	\$1,093.00			04-00341 ^B	\$533.00
Cessna 172XP	04-00299 ^B	\$410.95			04-00342 ^B	\$242.95
Cessna 177	04-00301 ^A	\$85.25	04-00333 ^A	\$89.50		
Cessna 182 (1961-69)	04-00303 ^B	\$570.00				
Cessna 182 (1971 SN 60752)	04-00305 ^B	\$576.00	04-00334 ^B	\$491.95	04-00343 ^B	\$643.00
Cessna 182 (1973 & up)	04-00307 ^B	\$369.95			04-00344 ^B	\$358.00
Cessna 182RG	04-00309 ^B	\$1,169.00	04-01942 ^B	\$809.00	04-01943 ^B	\$480.95
Cessna 206	04-00310 ^B	\$479.95			04-00347 ^B	\$532.00
Cessna 210	04-00311 ^B	\$1,152.00			04-00348 ^B	\$309.95
Cessna 310K	04-00312 ^B	\$3,186.00			04-00349 ^B	\$2,646.00
Cessna 320	04-00313 ^B	\$2,044.00			04-00351 ^B	\$2,395.00
Cessna 337	04-00315 ^B	\$1,933.00			04-00352 ^B	\$1,445.00
Cessna 340	04-00317 ^B	\$3,019.00			04-00353 ^B	\$1,420.00
Cessna 414	04-00319 ^B	\$1,634.00			04-00354 ^B	\$1,462.00
Cessna 421	04-00320 ^B	\$3,234.00			04-00355 ^B	\$2,277.00
Mooney 20J	04-00321 ^B	\$457.95	Kit contains Southco or Camloc studs, washers, and retainers. The retainer push on tool is only included in Southco Kits. Receptacles are not included. ^A is for Southco. ^B is for Camloc.			
Piper PA18	04-00322 ^A	\$66.12				
Piper Cheyenne	04-00006 ^B	\$1,312.00	The nose cowl components, if applicable, are not included in any cowling kit.			
Piper Comanche Twin (Nose)	04-00324 ^A	\$115.95				
Piper Comanche Twin	04-00325 ^B	\$2,224.00				

HA

CAMLOC FASTENER TOOLS

PLIERS



Camloc Fastener Pliers - With black-ox coating. For use with 2600, 2700 & 4002 Stud SeriesP/N 4P3.....\$19.50

CAMLOC HOLE SAWS



Camloc Fastener Tools. Available in .471" diameter and .687" diameter. .687" diaP/N 04-01517.....\$1,244.00

Other diameters available

2S200 SERIES DIMPLING TOOL

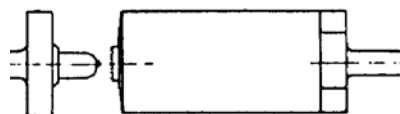

Camloc Fastener 2S200 Series Tools.
Dimpling tool only. Available in multiple sizes 2S200M-1, 2S200M-2, 2S200F-1.
1/4"x9/16"LP/N 2S200M-1.....\$967.00
5/16"x5/8"LP/N 2S200F-1.....\$967.00
5/16"x5/8"LP/N 2S200M-2.....\$624.00

4002 SERIES MEASURING TOOL



This handy tool is all stainless steel and engraved with Camloc fastener lengths from -2 to -11. Simply slide the Camloc fastener into the tool to determine the size (dash number) of the Camloc. A must for mechanics, paint shops, homebuilders, or anyone working with Camloc fasteners.

Note: Not for use with 2600 / 2700 Series
P/N 12-01598\$22.50

SOUTHCO FASTENERS

SOUTHCO STUDS

FLUSH SLOTTED



Flush Slotted #82 Stainless Steel	
Part No.	Price
82-14-180-20	---
Flush Slotted #82 Zinc Plated	
Part No.	Price
82-28-100-16	\$0.95
82-28-120-16	\$0.95
82-28-140-16	\$0.95
82-28-160-16	\$1.05
82-28-180-16	\$1.15
82-28-200-16	\$1.10
82-28-220-16	\$1.50
82-28-240-16	\$1.10
82-28-260-16	\$1.10
82-28-280-16	\$1.55
82-28-300-16	\$0.92
82-28-320-16	\$1.43
82-28-340-16	\$0.83

OVAL SLOTTED



Oval Slotted #82 Stainless Steel	
Part No.	Price
82-11-100-20	\$1.65
82-11-120-20	\$1.35
82-11-140-20	\$2.60
82-11-160-20	\$2.45
82-11-180-20	\$1.66
82-11-200-20	\$2.20
82-11-220-20	\$1.65
82-11-240-20	\$2.70
82-11-280-20	\$1.10
Oval Slotted #82 Zinc Plated	
Part No.	Price
82-11-100-16	\$1.15
82-11-120-16	\$1.45
82-11-140-16	\$1.70
82-11-160-16	\$1.85
82-11-180-16	\$1.80
82-11-200-16	\$1.60
82-11-220-16	\$1.95
82-11-240-16	\$1.00
82-11-260-16	\$1.80

Oval Head #82 Stainless Phillips	
Part No.	Price
82-19-120-20	\$1.50
82-19-140-20	\$1.50
82-19-160-20	\$1.25
82-19-180-20	\$1.50
82-19-200-20	\$1.50
82-19-220-20	\$1.35
Oval Head #85 Stainless Slotted	
Part No.	Price
85-11-100-20	\$0.84
85-11-140-20	\$1.50
85-11-160-20	\$1.81
85-11-180-20	\$2.75
85-11-200-20	\$1.55
85-11-220-20	\$1.55
85-11-240-20	\$1.35
85-11-260-20	\$1.75
85-11-280-20	\$1.58
85-11-300-20	\$1.65

Wing Head #85 Zinc plate, chromate plus sealer	
Part No.	Price
85-12-140-16	\$1.50
85-12-160-16	\$1.29
85-12-180-16	\$1.35
85-12-200-16	\$1.35
85-12-220-16	\$2.35
85-12-240-16	\$1.07
85-12-260-16	\$1.45
85-12-280-16	\$1.30
85-12-300-16	\$1.19
85-12-320-16	\$0.93
85-12-340-16	\$2.15
85-12-360-16	\$1.03
85-12-380-16	\$2.15
85-12-400-16	\$0.93

Wing Head #82 Dacrotized	
Part No.	Price
82-12-100-16	\$2.25
82-12-120-16	\$2.35
82-12-140-16	\$2.30
82-12-160-16	\$2.15
82-12-180-16	\$2.30
82-12-200-16	\$1.15
82-12-220-16	\$2.15
82-12-240-16	\$1.30
82-12-300-16	\$1.65
82-12-340-16	\$1.21

HA

WING HEAD



#82 SOUTHCO RECEPTACLES



FLOATING FOR RIVETING W/O BASE - This space saving stainless steel receptacle offers optimum weight savings by eliminating base.
P/N 82-35-295-20 \$1.50/ea



FLOATING FOR RIVETING W/ BASE - Full-floating dacrotized steel receptacle is mounted to inside panel with two 3/32" rivets. Compact dimensions save space and weight..... P/N 82-35-302-15 \$0.85/ea



FIXED FOR WELDING W/BASE - Exactly the same as the receptacle with base above except this receptacle features two welding studs for installation by welding rather than rivets P/N 82-35-303-15 \$2.92/ea



CLIP-ON RECEPTACLES - These versatile receptacles will fit material thickness from .020 to .190 by simply slipping over the hole and clipping in place. Easily removed as well, these receptacles do not require welding or riveting.
P/N 82-47-113-200 (Stainless Steel) \$1.75/ea
P/N 82-47-113-150 (Steel) \$0.47/ea



RUBBER VIBRATION ISOLATION RECEPTACLES - Use these receptacles where it is necessary to isolate vibration between panels.
P/N 82-35-306-10 \$8.80

#85 SOUTHCO RECEPTACLES



RIVET TYPE - Receptacle Spring: 1064 steel, dacrotized Base: 1010 steel, dacrotized.
P/N 85-35-295-15 \$2.35



RIVET TYPE - Receptacle Spring: 17-7 PH, stainless steel, passivated Base - 305 stainless steel, passivated P/N 85-35-295-20 \$3.35/ea



WELD TYPE - Receptacle Spring: 1064 steel, dacrotized Base: 101 steel, dacrotized Rivet: steel, copper-plated P/N 85-35-296-15 \$5.65/ea



CLIP-ON TYPE - 17-7 PH stainless steel, passivated.
P/N 85-47-101-20 \$2.05/ea

DETERMINING SOUTHCO STUD PART NO.

Stud Length	Selection Chart	Material	Thickness	Size
.090 - .109	100			
.110 - .129	120			
.130 - .149	140			
.150 - .169	160			
.170 - .189	180			
.190 - .209	200			
.210 - .229	220			
.230 - .249	240			
.250 - .269	260			
.270 - .289	280			

Southco studs are commonly used to secure Cessna cowlings, particularly on models 150, 172, and 177. We stock the popular Southco No. 82 1/4 turn fastener studs, receptacles, and accessories.

TO DETERMINE PART NO.

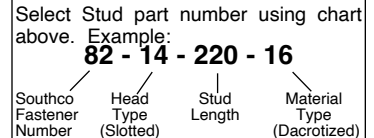

- SOUTHCO SEALING WASHER** - This black synthetic washer is used under head of Southco Studs..... P/N 82-43-201-38 \$0.25/ea
- SOUTHCO EJECTOR SPRING** - This stainless steel spring enables the stud head to stand away from the panel when the unit is not fastened. When using the ejector spring, add two grip lengths to stud length to allow for spring and wear washer P/N 43-13-1-24 \$0.20/ea
- SOUTHCO WEAR WASHER** - A plastic washer to reduce wear around the Southco stud. When using wear washer add one grip length to stud length selection P/N 82-46-101-39 \$0.25/ea.
- SOUTHCO SPLIT RING RETAINER** - Can be installed by hand or tool, and is fabricated from stainless steel.... P/N 82-32-101-20 \$0.10/ea
- SOUTHCO SPLIT RING RETAINER TOOL** - Designed to install Southco split ring retainers..... P/N 82-0-7596-11 \$38.65/ea
- SOUTHCO PUSH-ON RETAINER** - designed for installation using the retainer tool below. Stainless..... P/N 82-32-201-20 \$0.14/ea Plastic..... P/N 82-32-301-12 \$0.13/ea
- SOUTHCO PUSH-ON RETAINER TOOL** - An easy-to-use tool quickly installs Southco push-on retainers P/N 82-0-22542-11 .. \$36.50/ea
- SOUTHCO PUSH-ON RETAINER TOOL** - An easy-to-use tool quickly installs Southco 85 Series push-on retainers..... P/N 85-0-22543-11 \$42.50

#85 RETAINERS

- Split Ring** Hand or tool installation. Stainless steel. P/N 85-34-101-20 \$0.16/ea
- Push-On Tool installation only.** 302 Stainless Steel, Passivated P/N 85-34-201-20 \$0.13/ea
- Nylon Black** P/N 85-34-301-12 \$0.15/ea

#85 THERMOPLASTIC (CUPPED NYLON) WEAR WASHER

Natural color. Order stud one size longer than size you would use without washer. Adjustment Formula: Add 0.51/.020 to your total material thickness..... P/N 85-46-101-39 \$0.20/ea

SKYBOLT CESSNA COWLING FASTENER KITS

CESSNA COWLING STAINLESS SK203 FASTENER CONVERSION KITS

Attention (**): Retro Kit, for customers who have already converted to CLoc™ fasteners in the past but would like to upgrade to the next generation plate mount. (Does not include fasteners, grommets, etc.) Convert your existing "screw cowling" to CLoc™ ¼ Turn Stainless SK203 Fasteners, STC'd & FAA-PMA approved. Designed around the exclusive SK28S3 Wide Flange CLoc™ Fastener, to convert your Southco Cowlings to Heavy Duty SK40S5 CLoc™ ¼ Turn Stainless Fasteners. Cowling Conversion Kits are designed around the superior SK2003 Cowling Mount with Adjustable Receptacles!
FW = Firewall Kit

Aircraft	Serial No.	Description	Part No.	Price
C150	17001-64532	Convert C150 59-66 from screws to CLoc 25S4S Complete Kit	04-02179	\$372.00
C150	64533-79405	Convert C150G-M 67-On to CLoc 40S5S/28S3S Complete Kit	08-00666	\$545.00
C150	64533-79405	Convert C150G-M 67-On to CLoc 40S5S (FW & Sides)	04-02182	\$813.00
C150	64533-79405	Convert C150G-M 67-On to CLoc 40S5S (FW Only)	04-02258	\$492.00
C150	64533-79405	Convert C150G-M 67-On to CLoc 40S5S (Sides Only)	04-02180	\$147.75
C172	28000-54892	Convert C172 56-66 from screws to CLoc 25S4S Complete Kit	04-02185	\$492.00
C172	54893-75034	Convert C172H-P 67-81 to CLoc 40S5S Complete kit	08-00667	\$799.00
C172	54893-75034	Convert C172H-P 67-81 to CLoc 40S5S (FW Only)	04-02187	\$549.00
C172	54893-75034	Convert C172H-P 67-81 to CLoc 40S5S (Sides Only)	04-02186	\$325.00
C172	75035-76516	Convert C172P-Q 80-85 to CLoc 40S5S Complete Kit	08-00671	\$295.00
C172	75035-76516	Convert C172P-Q 80-85 to CLoc 40S5S (Sides Only)	04-02190	\$315.00
C172	R1722000-3454	Convert C172XP 77-81 to CLoc 40S5S Complete Kit	04-02191	\$819.00
C172	R1722000-3454	Convert C172XP 77-81 to CLoc 40S5S (FW Only)	04-02192	\$598.00
C172	R1722000-3454	Convert C172XP 77-81 to CLoc 40S5S (Sides Only)	04-02193	\$257.95
C172	80001/8001-On	Replace C172R-S 97-On CLoc 40S5S Complete Kit	04-02195	\$694.00
C172	80001/8001-On	Replace C172R-S 97-On CLoc 40S5S (FW Only)	04-02196	\$536.00
C175	55001-57119	Convert C175 58-62 from screws to CLoc 25S4S Complete Kit	04-02197	\$521.00
C177	00001-02752	Convert C177A-B, RG 68-78 to CLoc 40S5S Complete Kit	08-00668	\$869.00
C177	00001-02752	Convert C177A-B, RG 68-78 to CLoc 40S5S (FW Only)	04-02198	\$644.00
C177	00001-02752	Convert C177A-B, RG 68-78 to CLoc 40S5S (Sides)	04-02199	\$227.95
C180	30000-50911	Convert C180 53-60 from screws to CLoc 25S4S Complete Kit	04-02202	\$522.00
C182	33000-53007	Convert C182 56-60 from screws to CLoc 25S4S Complete Kit	04-02203	\$522.00
C182	61426-68542	Convert C182P-RB 73-86 27S3 to CLoc 40S5S Complete Kit	08-00669	\$771.00
C182	61426-68542	Convert C182P-RB 73-86 27S3 to CLoc 40S5S (FW)	04-02205	\$643.00
C150	64533-79405	**Upgrade C-150 Retrofit Kit - Plate Mount	04-02259	\$493.00
C172	75035-All XP	**Upgrade C-172 all XP Retrofit Kit - Plate Mount	04-02194	\$598.00
C177	00001-02752	**Upgrade C-177 Retrofit Kit - Plate Mount	04-02201	\$644.00
C182	61426-68542	**Upgrade C-182 Retrofit Kit - Plate Mount	04-02206	\$643.00

Note: RET Kits are for customers who have previously installed SK245 Kits and want to convert back to the SK2003 rubber mounts. RET Kits include new SK2003 Mounts, SK2003-AW Alignment Washers and all Hardware (No Studs or Grommets)

BEECH BONANZA & DEBONAIR COWLING REPLACEMENT AND CONVERSION KITS

Skybolt Replacement Fasteners are TSO-C148 approved. Skybolt Conversion Kits are STC'd for both TC A-777 and 3A15 that cover all Model 33, 35, and 36 Bonanza series. Conversion kits include easy to install SK215-435D Adjustable Receptacles that fit the same hole pattern as the original parts. Complete, up-to-date installation instructions, STC, along with Form 337 statement of conformance included.

Notes:

- 1: Includes studs and grommets.
- 2: Uses easy to install SK215-435D adjustable receptacles.
- 3: Includes studs and pins (no grommets). If grommets installed, they do not require removal to install new studs.
- 4: Slotted 2700 studs (small flange cups).
- 5: Phillips SK28S3 studs (wide flange).
- 6: 4000 series studs.

UPPER COWLING KITS				
Description	Model Serial Numbers	Part No.	Price	
Stainless Dzus Replacement Kit - Upper Cowlings TSO-C148. Tools required See T1 . (Includes studs and grommets.) Note 1	Bonanza 35 D1 thru D9068, Debonair 33 CD1-CD1234, C33A, E33A CE1-CE289	04-02207	\$49.50	
Stainless Phillips CLoc 40P Conversion Kit - Upper Cowlings STC Note 2	Bonanza 35 D1 thru D9068, Debonair 33 CD1-CD1234, C33A, E33A CE1-CE289	04-02208	\$153.75	
Stainless Slotted CLoc 40S Conversion Kit - Upper Cowlings STC Note 3	Bonanza 35 D1 thru D9068, Debonair 33 CD1-CD1234, C33A, E33A CE1-CE289	04-02209	\$154.75	
LOWER CHEEK COWLING KITS				
Description	Model Serial Numbers	Part No.	Price	
Stainless Airloc #2-090 Replacement Kit- Lower Cheek Cowling TSOC148. Tools requires see T3. (Note 3)	Bonanza 35 D1 thru D6567, Debonair 33 CD1 thru CD350	04-02210	\$194.00	
Stainless Airloc #5-080 Replacement Kit- Lower Cheek Cowling TSOC148. Tools required see T3. (Note 3)	Bonanza 35 D6568 thru D9068, 33 CD351 thru CD1304, CE-1 On, CJ26 On, 36 E1 thru E424	04-02213	\$200.75	
Stainless Airloc #5-100 Replacement Kit- Lower Cheek Cowling TSOC148. See T3	Bonanza V35B D9069 On, 36TC EA1 On, 36 E425 On (Note 3)	04-02215	\$212.95	
Stainless Phillips CLoc 27S Conversion Kit - Lower Cheek Cowling STC Note 4	Bonanza 35 D1 thru D6567, Debonair 33 CD1 thru CD350	04-02212	\$236.95	
Stainless Phillips Cloc 40P Conversion Kit - Lower Cheek Cowling STC. See T2 Note 6	Bonanza 35 D6568 On, 33 CD351 On, CE-1 On, CJ26 On, 36 E1 On	04-02214	\$305.00	
Stainless Slotted Cloc 40S Conversion Kit - Lower Cheek Cowling STC Note 6	Bonanza V35B D9069-On, 36TC EA1-On, 36 E425-On	04-02217	\$306.00	

INSTALL TOOLS

Skybolt SK2018C Clamp Assembly. In The Box: 1 - Clamp, 2 - Sets of Screws P/N 04-04088 \$199.75
 4P3-T26 - Used to install CLoc 4000 Series studs into grommets. SK-T26 - Two Tools in One - For all SK4002 Grommet R4G Retainers and SK2600-LW Retainers P/N 04-01990 \$87.75



SKYBOLT VANS RV COWLING FASTENER KITS

COWLING MOUNTING KITS

Kits Include SK215 and SK245 Dash 4 Series Receptacles and SK-RVFS1 Flanges

Skybolt Part No.	Aircraft	Description	Part No.	Price
RV4J-C1S	Vans RV4 - Complete Kit	38 Collared Slotted Fasteners	04-00399	\$383.00
RV4J-C1P	Vans RV4 - Complete Kit	Phillips	04-00403	\$383.00
RV4J-C1S-U	Vans RV4 - Upper (FW/Side) Kit	30 Collared Slotted Fasteners	04-02238	\$337.00
RV4J-C1P-U	Vans RV4 - Upper (FW/Side) Kit	Phillips	04-02041	\$401.00
RV4J-C1S-F	Vans RV4 - Complete Firewall Kit	18 Collared Slotted Fasteners	04-00405	\$209.95
RV4J-C1P-F	Vans RV4 - Complete Firewall Kit	Phillips	04-00406	\$212.95
RV4J-C1S-UF	Vans RV4 - Upper Firewall Kit	10 Collared Slotted Fasteners	04-02240	\$123.85
RV4J-C1P-UF	Vans RV4 - Upper Firewall Kit	Phillips	04-02042	\$149.75
RV4J-C1S-S	Vans RV4 - Side Kit	20 Collared Slotted Fasteners	04-00407	\$231.95
RV4J-C1P-S	Vans RV4 - Side Kit	Phillips	04-00408	\$224.95
RV4J-C1S-C	Vans RV4 - Cheek Cowl Kit	8 Collard Slotted Fasteners	04-02241	\$101.75
RV4J-C1P-C	Vans RV4 - Cheek Cowl Kit	Phillips	04-02242	\$104.75
RV8J-C1S	Vans RV8 - Complete Kit	50 Collared Slotted Fasteners	04-00409	\$489.00
RV8J-C1P	Vans RV8 - Complete Kit	Phillips	04-00410	\$550.00
RV8J-C1S-U	Vans RV8 - Upper (FW/Side) Kit	34 Collared Slotted Fasteners	04-02243	\$376.00
RV8J-C1P-U	Vans RV8 - Upper (FW/Side) Kit	Phillips	04-02043	\$343.00
RV8J-C1S-F	Vans RV8 - Complete Firewall Kit	30 Collared Slotted Fasteners	04-00411	\$324.00
RV8J-C1P-F	Vans RV8 - Complete Firewall Kit	Phillips	04-00412	\$334.00
RV8J-C1S-UF	Vans RV8 - Upper Firewall Kit	14 Collared Slotted Fasteners	04-02244	\$163.75
RV8J-C1P-UF	Vans RV8 - Upper Firewall Kit	Phillips	04-02044	\$199.00
RV8J-C1S-S	Vans RV8 - Side Kit	20 Collared Slotted Fasteners	04-00413	\$231.95
RV8J-C1P-S	Vans RV8 - Side Kit	Phillips	04-00415	\$146.80
RV679J-C1S	Vans RV6,7,9 - Complete Kit	52 Collared Slotted Fasteners	04-02245	\$507.00
RV679J-C1P	Vans RV6,7,9 - Complete Kit	Phillips	04-00418	\$589.00
RV679J-C1S-U	Vans RV6,7,9 - Upper (FW/Side) Kit	36 Collared Slotted Fasteners	04-00417	\$395.00
RV679J-C1P-U	Vans RV6,7,9 - Upper (FW/Side) Kit	Phillips	04-02045	\$399.00
RV679J-C1S-F	Vans RV6,7,9 - Complete Firewall Kit	32 Collared Slotted Fasteners	04-00419	\$349.00
RV679J-C1P-F	Vans RV6,7,9 - Complete Firewall Kit	Phillips	04-00420	\$330.00
RV679J-C1S-UF	Vans RV6,7,9 - Upper Firewall Kit	16 Collared Slotted Fasteners	04-02246	\$195.80
RV679J-C1P-UF	Vans RV6,7,9 - Upper Firewall Kit	Phillips	04-02046	\$221.95
RV679J-C1S-S	Vans RV6,7,9 - Side Kit	20 Collared Slotted Fasteners	04-00421	\$231.95
RV679J-C1P-S	Vans RV6,7,9 - Side Kit	Phillips	04-00422	\$237.95
RV10J-C1S	Vans RV10 - Complete Kit	62 Collared Slotted Fasteners	04-02247	\$650.00
RV10J-C1P	Vans RV10 - Complete Kit	Phillips	04-02157	\$658.00
RV10J-C1S-U	Vans RV10 - Upper (FW/Side) Kit	45 Collared Slotted Fasteners	04-02158	\$481.00
RV10J-C1P-U	Vans RV10 - Upper (FW/Side) Kit	Phillips	04-02154	\$495.00
RV10J-C1S-F	Vans RV10 - Complete Firewall Kit	36 Collared Slotted Fasteners	04-02159	\$385.00
RV10J-C1P-F	Vans RV10 - Complete Firewall Kit	Phillips	04-02156	\$395.00
RV10J-C1S-UF	Vans RV10 - Upper Firewall Kit	19 Collared Slotted Fasteners	04-02248	\$212.95
RV10J-C1P-UF	Vans RV10 - Upper Firewall Kit	Phillips	04-02155	\$279.00
RV10J-C1S-S	Vans RV10 - Side Kit	26 Collared Slotted Fasteners	04-02160	\$289.95
RV10J-C1P-S	Vans RV10 - Side Kit	Phillips	04-02161	\$296.95
LANCAIR-C1S	Lancair - Complete Kit	62 Collared Slotted Fasteners (Inc SK2800S)	04-00423	\$755.00
LANCAIR-C1P	Lancair - Complete Kit	Phillips (Inc SK28S3S around gear well)	04-00424	\$758.00
LANCAIR-C1S-U	Lancair - Upper Cowl Kit	45 Collared Slotted Fasteners	04-02249	\$484.00
LANCAIR-C1P-U	Lancair - Upper Cowl Kit	Phillips	04-02047	\$577.00
LANCAIR-C1S-F	Lancair - Firewall Kit	36 Collared Slotted Fasteners	04-00425	\$381.00
LANCAIR-C1P-F	Lancair - Firewall Kit	Phillips	04-02048	\$460.00
LANCAIR-C1S-UF	Lancair - Upper Firewall Kit	19 Collared Slotted Fasteners	04-02250	\$212.95
LANCAIR-C1P-UF	Lancair - Upper Firewall Kit	Phillips	04-02251	\$217.95
LANCAIR-C1S-S	Lancair - Side Kit	26 Collared Slotted Fasteners	04-02252	\$291.95
LANCAIR-C1P-S	Lancair - Side Kit	Phillips	04-02049	\$348.00
RV-OD1	Oil Door Winged Fasteners (Skytanium)	2 ea ZG2600-1W, SK213-2, Drill Template	04-02253	\$23.50
RV-OD2	Oil Door Phillips Fasteners (Stainless)	2 ea SK28S3-2S, SK213-2, Drill Template	04-02254	\$18.50
SK-RVFS1	Inter-Locking Flange (Patent Pending)	1 ea Flange	04-02255	\$5.35
SK-RVCI	Cleko Insert	1 ea Insert	04-02256	\$2.39
SK-4002-TS2	Installation Tool Set	SK-4P3 Pliers, T26 Tool, Unibit-1, Unibit-4	04-02257	\$109.95
4P3-T26	Stud Installation Pliers, Retainer Installation Tool		04-01990	\$87.75

HA

CLICK BOND FASTENERS

CLICK BOND FASTENERS

Click Bond Fasteners mount to surfaces with adhesive. They are assembled in a disposable, self-fixturing device of plastic that aligns and holds the fastener in position and under controlled pressure while the bonding material cures. After the installation is completed, the holding fixture is removed and the conventional attachment is made to the fastener. Bonded fasteners eliminate welding or drilling surfaces and result in reinforced substrate strength, leakproof and corrosion resistant attachments. Aircraft Spruce & Specialty Co. offers Click Bond Fasteners in convenient, pre-packaged kits as shown.

CABLE TIE MOUNT KIT



Each cable tie mount in this kit is pre-assembled in a temporary, easy-to-remove fixture that holds the cable tie mount in place and under pressure while the adhesive cures. No additional installation tools are needed. The kit includes four CB3019AA3N cable tie mounts with nylon ties (5" 40 lbs.), one adhesive packet, surface preparation materials, and instructionsP/N 04-06000**\$52.75**

FLOATING NUT-PLATE KIT



The Click Bond adhesive bonded floating nutplate has a metal base and is installed using a disposable, elasto-meric fixture that temporarily holds the nutplate in place and under pressure while the adhesive cures. The fixture prevents fouling of the clearance hole. No additional tools are needed for making the nutplate attachment. This fastener meets or exceeds the standards set by MIL-N-25027 for push-out, torque-out, and cycle life. Bonded nutplates eliminate composite damaging rivets, reinforce the structure, and reduce installation time. The kit includes four CB2009A3S floating nutplates (10-32) with aluminum baseplate, one adhesive packet, surface preparation materials, and instructionsP/N 04-06005**\$58.75/ea.**

CB 200 ACRYLIC ADHESIVE



A high strength, two part adhesive. 3.5 gram package. One package is usually sufficient to do five of any Click Bond fasteners. P/N 04-06040**\$9.65**

CB92 ADHESIVE MIX KIT



The CB92 Acrylic adhesive & prep material kit includes adhesive package (3.5 grams) mixing plate, mixing stick, abrasive pad, solvent wipe package, and instructions. P/N 04-02059**\$21.65**

CLICK BOND CB904 - DISPOSABLE ABRASIVE PAD



Abrasive pad used to prepare substrate for bonding fasteners. Abrade substrate where part is to be installed. Remove surface oxides, top coat, and primer to expose bare metal. Always solvent wipe to remove abrasion residue prior to bonding part to substrate.....P/N 04-04076**\$0.48**

CLICK BOND CB911 - SOLVENT WIPE



Pre-saturated wipe contains Click Bond recommended solvent blend optimized for surface preparation of metallic and composite substrates and Click Bond adhesive-bonded fasteners. CB911 solvent blend has perfect balance of aggressiveness, material compatibility, and flashoff time to deliver optimal surface cleanliness.....P/N 04-04077**\$2.59**

CLICK BOND CB106 - ADHESIVE DISPENSER MIXING TIP



Recommended for use in conjunction with Click Bond adhesive cartridges, the CB106 static mixing tip provides thorough mixing of adhesive components during dispensing, ensuring optimal adhesive consistency and bond strength. Designed to twist and lock onto the end of the Click Bond adhesive cartridge, Click Bond mixing tips provide not only proper interleaving of pre-ratioed components but additionally pre-phasing to ensure optimum mix uniformity.....P/N 04-04075**\$2.50**

STUD KITS



Click Bond studs are available in several sizes. The Metal Small Base Stud Kit includes six CS62-1032-12AX-CR aluminum small base stainless studs, six stainless nylocks/washers (10-32), one adhesive packet, surface preparation materials, and instructions.

Metal Small Base Stud Kit.....P/N 04-06020**\$59.65**
Metal Large Base Stud KitP/N 04-06025**\$52.75**
Fiberglass Base Stud Kit.....P/N 04-06030**\$53.95**

EZ-POINT NUTS & STUDS FOR COMPOSITES



Creating a hard point in a composite laminated structure has never been easier. Simply drill a hole, prep the area, apply structural adhesive to the alodined, cleaned surface of the EZ-Point and snap into place. Simple and clean. For secondary structural applications, apply three plies of bid cloth to the area. Un-glassed samples were tested to failure in excess of 200 lbs. in shear. Glassed samples exceeded testing ability at over 500 lbs. Perfect for Adel clamps, trim and auto pilot servos, hydraulics, anything but primary structure. Available in 8-32, 10-32, 1/4 - 20, 1/4 - 28, your choice of locking, blind and studs. Used extensively in the installation of the Flesher 360 interior for the Lancair. Thread 8-32.....P/N 04-0633**\$3.35**

EZ-POINT STRIPS FOR COMPOSITES



Take the guesswork out of nut plate spacing with EZ-Point Strips. They maintain consistent spacing while remaining flexible enough to conform to curvature. Perfect for cowling attachments, Access doors, removable wingtips, anywhere you would use a standard 10/32 or 8/32 nut plate. Locking threads, available in one, two and three inch centers. Sold in one-foot sections. 8-32 thread, 3" centers.....P/N 04-06460**\$57.95 ea.**
10-32 thread, 1" centersP/N 04-06465**\$46.75 ea.**

CLICK BOND ADHESIVE DISPENSERS SLIDES



OEM #	Description	Application	Part No.	Price
CB11	Adhesive Dispenser Slide, 1:1 Ratio	For use with CB100 Adhesive Dispenser used with CB250-50 & CB309-50 Adhesive Cartridges	04-04070	\$18.75
CB21	Adhesive Dispenser Slide, 2:1 Ratio	For use with CB100 Adhesive Dispenser used with CB301-50 & CB359-50 Adhesive Cartridges	04-04071	\$18.75
CB41	Adhesive Dispenser Slide, 4:1 Ratio	For use with CB100 Adhesive Dispenser used with CB394-43	04-04072	\$17.65
CB81	Adhesive Dispenser Slide, 8:1 Ratio	For use with CB100 Adhesive Dispenser used with CB200-40, CB420-50 & CB420-50E Adhesive Cartridges	04-04073	\$19.65

CLICK BOND CB100 - ADHESIVE DISPENSER



Manual adhesive dispenser designed for use with Click Bond two-component adhesive cartridges. The dispenser handle is paired with specific slides for proper dispensing of materials of various component ratios.....P/N 04-04074**\$78.75**

HA

AN FITTINGS

The aircraft fittings shown on the following pages conform to current AN and MS specifications. We stock aluminum, brass and/or steel fittings. Fittings not regularly stocked can be special ordered. Order by Part Number. Example: AN840-8D.



AN804
TEE, FLARED TUBE WITH
BULKHEAD ON RUN

Size No.	Tube		Thread Size	Price Each	
	Steel	Alum.		Steel	Alum.
3	3D	3/16	3/8-24	\$32.50	\$17.85
4	4D	1/4	7/16-20	---	\$15.55
5	5D	5/16	1/2-20	---	\$25.75
6	6D	3/8	9/16-18	\$33.50	\$16.65
8	8D	1/2	3/4-16	---	\$23.55
10	10D	5/8	7/8-14	---	\$30.65
12	12D	3/4	1-1/16-12	---	---



AN806
FLARED TUBE PLUG

Size No.	Tube		Thread Size	Price Each	
	Steel	Alum.		Steel	Alum.
2	2D	1/8	5/16-24	\$22.75	\$2.11
3	3D	3/16	3/8-24	\$9.50	\$1.35
4	4D	1/4	7/16-20	\$7.75	\$1.17
5	5D	5/16	1/2-20	\$12.90	\$1.53
6	6D	3/8	9/16-18	\$8.75	\$1.98
8	8D	1/2	3/4-16	\$11.50	\$2.57



AN807
ADAPTER HOSE
TO UNIVERSAL

Size No.	Hose		Thread Size	Price Each	
	Brass	Alum.		Brass	Alum.
4	4D	1/4	7/16-20	---	\$9.80
6	6D	3/8	9/16-18	---	\$14.80
8	8D	1/2	3/4-16	---	\$14.50

HA



AN814
PLUG AND BLEEDER,
SCREW THREAD

Size No.	Tube		Thread Size	Price Each	
	Steel	Alum.		Steel	Alum.
2	2D	1/8	5/16-24	---	\$2.56
3	3D	3/16	3/8-24	\$13.95	\$3.50
4	4D	1/4	7/16-20	\$11.50	\$3.35
5	5D	5/16	1/2-20	\$10.65	\$2.82
6	6D	3/8	9/16-18	\$31.50	\$4.55
8	8D	1/2	3/4-16	\$9.50	\$6.60
10	10D	5/8	7/8-14	---	\$4.75
12	12D	3/4	1-1/16-12	\$38.75	\$14.80



AN815
UNION, FLARED TUBE

Size No.	Tube		Thread Size	Price Each	
	Steel	Alum.		Steel	Alum.
2	2D	1/8	5/16-24	\$16.55	\$4.85
3	3D	3/16	3/8-24	\$11.75	\$3.45
4	4D	1/4	7/16-20	\$8.55	\$3.35
5	5D	5/16	1/2-20	\$10.85	\$3.75
6	6D	3/8	9/16-18	\$11.90	\$3.35
8	8D	1/2	3/4-16	\$20.60	\$6.95
10	10D	5/8	7/8-14	---	\$10.50
12	12D	3/4	1-1/16-12	\$18.50	\$18.90

SS AN815-4J.....P/N AN815-4J .. \$10.50
SS AN815-6J.....P/N AN815-6J .. \$10.65



AN816
NIPPLE, FLARED TUBE
AND PIPE THREAD

Size No.	Tube		Pipe Size	Price Each	
	Steel	Alum.		Steel	Alum.
2	2D	1/8	1/8	\$42.50	\$4.95
3	3D	3/16	1/8	\$8.50	\$2.43
4	4D	1/4	1/8	\$8.65	\$2.39
4-4	4-4D	1/4	1/4	\$6.50	\$2.85
5	5D	5/16	1/8	\$12.50	\$3.70
6	6D	3/8	1/4	\$9.95	\$3.65
6-2	6-2D	3/8	1/8	\$9.85	\$3.35
6-6	6-6D	3/8	3/8	\$10.50	\$3.85
7	7D	1/2	1/4	\$14.85	\$5.80
8	8D	1/2	3/8	\$11.95	\$6.95
10	10D	5/8	1/2	\$47.90	\$9.50
12	12D	3/4	3/4	---	\$13.80

SS AN816-4J.....P/N AN816-4J .. \$10.50



AN818
NUT, COUPLING

Size No.	Tube		Thread Size	Price Each	
	Steel	Alum.		Steel	Alum.
2	2D	1/8	5/16-24	\$9.50	\$0.82
3	3D	3/16	3/8-24	\$3.35	\$0.90
4	4D	1/4	7/16-20	\$2.45	\$0.83
5	5D	5/16	1/2-20	\$5.50	\$1.16
6	6D	3/8	9/16-18	\$3.85	\$1.35
8	8D	1/2	3/4-16	\$2.85	\$1.90
10	10D	5/8	7/8-14	\$8.50	\$3.35
12	12D	3/4	1-1/16-12	\$14.50	\$3.90

SS AN818-4J.....P/N AN818-4J \$2.45
SS AN818-6J.....P/N AN818-6J \$4.35



AN819
(MS20819)
SLEEVE, COUPLING

Size No.	Tube		O.D.	Price Each	
	Steel	Alum.		Steel	Alum.
2	2D	1/8		\$1.19	\$0.76
3	3D	3/16		\$1.22	\$0.77
4	4D	1/4		\$1.33	\$0.59
5	5D	5/16		\$7.50	\$0.92
6	6D	3/8		\$1.64	\$0.82
8	8D	1/2		\$4.35	\$1.52
10	10D	5/8		\$4.95	\$2.25
12	12D	3/4		\$4.80	---



AN821
ELBOW, FLARED TUBE, 90°

Size No.	Tube		Thread Size	Price Each	
	Steel	Alum.		Steel	Alum.
--	2D	1/8	5/16-24	---	\$30.90
3	3D	3/16	3/8-24	\$21.50	\$13.55
4	4D	1/4	7/16-20	\$27.50	\$9.50
5	5D	5/16	1/2-20	---	\$10.50
6	6D	3/8	9/16-18	\$26.95	\$12.50
8	8D	1/2	3/4-16	\$26.50	\$14.60
10	10D	5/8	7/8-14	\$32.25	\$32.50
--	12D	3/4	1-1/16-12	---	\$38.50
--	16D	1	1-5/16-12	---	\$63.75

New Surplus AN821-5D.....P/N 04-03303.....\$5.85



AN822
(MS20822)
ELBOW, FLARED TUBE
AND PIPE THREAD, 90°

Size No.	Tube		Pipe Size	Price Each	
	Steel	Alum.		Steel	Alum.
2	2D	1/8	1/8	---	\$31.75
3	3D	3/16	1/8	\$15.75	\$11.95
4	4D	1/4	1/8	\$22.80	\$10.80
4-4	4-4D	1/4	1/4	\$21.50	\$17.50
-	5-4D	5/16	1/4	---	\$16.85
5	5D	5/16	1/8	\$27.50	\$13.55
6	6D	3/8	1/4	\$34.50	\$10.90
6-2	6-2D	3/8	1/8	\$22.70	\$13.50
6-6	6-6D	3/8	3/8	\$33.50	\$15.75
8	8D	1/2	3/8	\$22.50	\$17.80
10	10D	5/8	1/2	\$122.75	\$21.50
12	12D	3/4	3/4	---	\$27.50



AN823
(MS20823)
ELBOW, FLARED TUBE
AND PIPE THREAD, 45°

Size No.	Tube		Pipe Thread	Price Each	
	Steel	Alum.		Steel	Alum.
2	2D	1/8	1/8	---	\$33.50
3	3D	3/16	1/8	\$22.90	\$14.85
4	4D	1/4	1/8	\$22.60	\$11.60
5	5D	5/16	1/8	---	\$17.85
6	6D	3/8	1/4	\$29.80	\$9.75
8	8D	1/2	3/8	\$30.85	\$19.75
10	10D	5/8	1/2	---	\$38.85
12	12D	3/4	3/4	---	---



AN824
TEE, FLARED TUBE

Size No.	Tube		Thread Size	Price Each	
	Steel	Alum.		Steel	Alum.
2	2D	1/8	5/16-24	---	\$32.85
3	3D	3/16	3/8-24	\$24.50	\$23.50
4	4D	1/4	7/16-20	\$25.80	\$12.50
5	5D	5/16	1/2-20	\$24.50	\$12.50
6	6D	3/8	9/16-18	\$31.60	\$11.50
8	8D	1/2	3/4-16	\$27.80	\$21.50
10	10D	5/8	7/8-14	\$45.00	\$26.75
12	12D	3/4	1-1/16-12	---	\$32.50

AN FITTINGS



AN825 (MS20825)
TEE, FLARED TUBE WITH
PIPE THREAD ON SIDE

Size No.	Tube		Pipe Thread	Price Each	
	Steel	Alum.		Steel	Alum.
2	2D	1/8	1/8	---	\$33.65
3	3D	3/16	1/8	---	\$15.60
4	4D	1/4	1/8	\$19.50	\$13.75
5	5D	5/16	1/8	\$8.90	\$20.50
6	6D	3/8	1/4	---	\$15.90
8	8D	1/2	3/8	---	\$31.85
10	10D	5/8	1/2	---	\$30.90
12	12D	3/4	3/4	---	---
16	16D	1	5/16	---	\$38.75

New Surplus AN825-10D ... P/N 04-02226.. \$12.90



AN826 (MS20826)
TEE TUBE WITH
PIPE THREAD ON RUN

Size No.	Tube		Pipe Thread	Price Each	
	Steel	Alum.		Steel	Alum.
3	3D	3/16	1/8	---	\$17.50
4	4D	1/4	1/8	\$32.50	\$11.95
5	5D	5/16	1/8	---	\$15.85
6	6D	3/8	1/4	\$28.50	\$15.50
8	8D	1/2	3/8	\$26.50	\$20.60
10	10D	5/8	1/2	---	---
12	12D	3/4	3/4	---	\$31.65



AN827
CROSS, FLARED TUBE

Size No.	Tube		Thread Size	Price Each	
	Steel	Alum.		Steel	Alum.
2	2D	1/8	5/16-24	---	---
3	3D	3/16	3/8-24	---	\$23.70
4	4D	1/4	7/16-20	---	\$21.50
5	5D	5/16	1/2-20	---	\$20.50
6	6D	3/8	9/16-18	---	\$21.75
8	8D	1/2	3/4-16	---	---
10	10D	5/8	7/8-14	---	---
12	12D	3/4	1-1/16-12	---	\$30.95



AN832
UNION, FLARED TUBE,
BULKHEAD & UNIVERSAL

Size No.	Tube		Thread Size	Price Each	
	Steel	Alum.		Steel	Alum.
2	2D	1/8	5/16-24	\$11.85	\$8.55
3	3D	3/16	3/8-24	\$10.80	\$5.25
4	4D	1/4	7/16-20	\$10.50	\$4.75
5	5D	5/16	1/2-20	\$66.75	\$9.65
6	6D	3/8	9/16-18	\$26.50	\$5.70
8	8D	1/2	3/4-16	\$27.85	\$10.55
10	10D	5/8	7/8-14	\$31.75	\$12.70
12	12D	3/4	1-1/16-12	\$45.50	\$22.50

SS AN832-3J..... P/N AN832-3J. \$20.85
SS AN832-4J..... P/N AN832-4J. \$17.80
SS AN832-6J..... P/N AN832-6J. \$15.50



AN833
ELBOW, FLARED TUBE
BULKHEAD AND
UNIVERSAL, 90°

Size No.	Tube		Thread Size	Price Each	
	Steel	Alum.		Steel	Alum.
2	2D	1/8	5/16-24	\$64.75	\$27.60
3	3D	3/16	3/8-24	\$25.50	\$13.50
4	4D	1/4	7/16-20	\$23.85	\$11.95
5	5D	5/16	1/2-20	---	\$12.50
6	6D	3/8	9/16-18	\$16.85	\$16.75
8	8D	1/2	3/4-16	\$31.55	\$18.50
10	10D	5/8	7/8-14	---	\$22.50
12	12D	3/4	1-1/16-12	---	\$27.50



AN834
TEE, FLARED T, BE,
BULKHEAD & UNIVERSAL

Size No.	Tube		Thread Size	Price Each	
	Steel	Alum.		Steel	Alum.
2	2D	1/8	5/16-24	---	---
3	3D	3/16	3/8-24	---	\$23.50
4	4D	1/4	7/16-20	\$29.65	\$15.65
5	5D	5/16	1/2-20	---	\$22.50
8	8D	1/2	3/4-16	---	\$21.80
10	10D	5/8	7/8-14	---	\$23.65
12	12D	3/4	1-1/16-12	---	---

New Surplus AN834-6.....P/N 04-02273... \$35.60



AN838
ELBOW, BULKHEAD &
HOSE TO UNIVERSAL, 90°

Size No.	Hose		Thread Size	Price Each	
	Brass	Alum.		Brass	Alum.
4	4D	1/4	7/16-20	---	\$28.50
6	6D	3/8	9/16-18	---	\$93.75



AN840
HOSE NIPPLE, PIPE
THREAD

Size No.	Hose		Pipe Size	Price Each	
	Brass	Alum.		Brass	Alum.
4	4D	1/4	1/8	\$20.65	\$4.35
6	6D	3/8	1/4	---	\$4.35
8	8D	1/2	3/8	\$19.90	\$8.50
---	10D	5/8	1/2	---	\$23.50
12	12D	3/4	3/4	\$47.50	\$14.60



AN837
ELBOW, FLARED TUBE,
BULKHEAD AND
UNIVERSAL, 45°

Size No.	Tube		Thread Size	Price Each	
	Steel	Alum.		Steel	Alum.
2	2D	1/8	5/16-24	---	---
3	3D	3/16	3/8-24	\$31.50	\$17.60
4	4D	1/4	7/16-20	---	\$14.65
5	5D	5/16	1/2-20	---	\$15.50
6	6D	3/8	9/16-18	\$30.50	\$16.50
8	8D	1/2	3/4-16	\$34.50	\$19.75
10	10D	5/8	7/8-14	---	\$29.85
12	12D	3/4	1-1/16-12	---	---



AN844
HOSE ELBOW,
PIPE THREAD, 45°

Size No.	Hose		Pipe Thread	Price Each	
	Brass	Alum.		Brass	Alum.
4	4D	1/4	1/8	---	\$23.50
6	6D	3/8	1/4	---	\$22.50
8	8D	1/2	3/8	---	\$58.75
10	10D	5/8	1/2	\$16.55	---
12	12D	3/4	3/4	---	\$35.80



AN848
ELBOW, HOSE
BULKHEAD, 90°

Size No.	Hose		Thread Size	Price Each	
	Brass	Alum.		Brass	Alum.
---	4D	1/4	7/16-20	---	---
---	6D	3/8	9/16-18	---	\$68.75
---	8D	1/2	3/4-16	---	---



AN842
HOSE ELBOW, PIPE
THREAD, 90°

Size No.	Hose		Pipe Thread	Price Each	
	Brass	Alum.		Brass	Alum.
4	4D	1/4	1/8	\$28.50	\$19.50
6	6D	3/8	1/4	\$28.50	\$23.50
8	8D	1/2	3/8	---	\$29.55
10	10D	5/8	1/2	---	\$29.65
12	12D	3/4	3/4	---	\$36.65



AN910
COUPLING PIPE THREAD

Size No.	Thread		Price Each	
	Brass	Alum.	Brass	Alum.
1	1D	1/8	\$4.90	\$3.35
2	2D	1/4	\$16.95	\$4.35
3	3D	3/8	---	\$6.85
4	4D	1/2	---	\$7.50
6	6D	3/4	---	\$14.80



AN912
BUSHING PIPE
THREAD REDUCER

Size No.	Pipe Size	Price Ea.	Size No	Pipe Size	Price Ea.
1D	1/4-1/8	\$4.35	8D	3/4-3/8	\$21.70
2D	3/8-1/4	\$4.65	9D	3/4-1/4	\$14.75
3D	3/8-1/8	\$5.35	10D	1-3/4	\$11.95
4D	1/2-3/8	\$5.95	11D	1-1/2	---
5D	1/2-1/4	\$7.90	12D	1-3/8	\$23.50
6D	1/2-1/8	\$15.65	13D	11/4-3/4	---
7D	3/4-1/2	\$14.90			

New Surplus AN912-11D..... P/N 04-02271.... \$27.50



AN894
FLARED TUBE
REDUCER AND EXPANDERS

Fitting No.	Price
AN894-6-5D	\$17.95
AN894-D6-4	\$5.45
AN894-D12-6	\$42.95



AN911 NIPPLE
PIPE THREAD

Size No.	Pipe Thread		Price Each	
	Brass	Alum.	Brass	Alum.
1	1D	1/8	\$14.65	\$3.35
2	2D	1/4	\$7.75	\$3.60
3	3D	3/8	\$7.50	\$4.95
4	4D	1/2	---	\$11.50
6	6D	3/4	\$53.75	\$21.50

AN FITTINGS



**AN913 (MS20913)
PLUG SQUARE HEAD,
PIPE THREAD**

Size No.		Pipe Thread	Price Each			
Brass	Steel		Alum.	Brass	Steel	Alum.
1	1S 1D	1/8	\$21.50	---	\$9.80	
2	2S 2D	1/4	\$17.50	---	\$10.70	
3	3S 3D	3/8	\$19.50	---	\$27.65	
4	4S 4D	1/2	---	---	\$11.70	
6	6S 6D	3/4	---	---	---	



**AN914
ELBOW, INTERNAL
AND EXTERNAL
PIPE THREAD, 90°**

Size No.		Pipe Thread	Price Each	
Brass	Alum.		Brass	Alum.
1	1D	1/8	---	\$13.50
2	2D	1/4	\$53.75	\$76.75
3	3D	3/8	\$51.75	\$64.75
4	4D	1/2	---	---



**AN915
ELBOW, INTERNAL
AND EXTERNAL
PIPE THREAD, 45°**

Size No.		Pipe Thread	Price	
Brass	Alum.		Brass	Alum.
1	1D	1/8	---	\$21.50
2	2D	1/4	---	\$18.80
3	3D	3/8	---	\$99.75
4	4D	1/2	---	\$32.50
6	6D	3/4	---	\$29.50

New Surplus AN915-6D P/N 04-02233... \$24.50



**AN916
ELBOW, INTERNAL PIPE
THREAD, 90°**

Size No.		Pipe Thread	Price	
Brass	Alum.		Brass	Alum.
1	1D	1/8	\$23.50	\$16.75
2	2D	1/4	---	---
3	3D	3/8	---	\$29.50
4	4D	1/2	---	\$77.75
6	6D	3/4	---	---

New Surplus AN916-6D P/N 04-02176... \$15.60
New Surplus AN916-3 Brass... P/N 04-03012... \$20.75



**AN917
TEE, INTERNAL,
PIPE THREAD**

Size No.		Pipe Thread	Price	
Brass	Alum.		Brass	Alum.
1	1D	1/8	---	\$16.00
2	2D	1/4	---	\$20.50
3	3D	3/8	---	\$27.50
4	4D	1/2	\$88.75	\$52.75
6	6D	3/4	---	---



**AN919
REDUCER, EXTERNAL
THREAD**

Size No.		Tube O.D.	Price	
Steel	Alum.		Steel	Alum.
0	0D	3/16-1/8	\$15.50	\$3.50
1	1D	1/4-1/8	\$22.90	\$4.80
2	2D	1/4-3/16	\$21.50	\$4.35
3	3D	5/16-1/4	\$13.80	\$5.75
4	4D	3/8-1/8	\$20.55	\$5.35
5	5D	3/8-3/16	---	\$5.35
6	6D	3/8-1/4	\$12.50	\$3.60
7	7D	3/8-5/16	---	\$7.35
8	8D	1/2-1/8	---	\$7.50
9	9D	1/2-3/16	---	\$18.50
10	10D	1/2-1/4	---	\$16.90
11	11D	1/2-5/16	\$51.75	\$14.50
12	12D	1/2-3/8	\$43.50	\$10.90
19	19D	3/4-1/2	---	\$17.50



**AN924
NUT, FLARED TUBE, BULKHEAD
AND UNIVERSAL FITTING**

Size No.		Tube O.D.	Thread Size	Price	
Steel Black	Alum. Blue			Steel	Alum.
2	2D	1/8	5/16-24	---	\$1.70
3	3D	3/16	3/8-24	\$1.74	\$0.88
4	4D	1/4	7/16-20	\$10.65	\$1.32
5	5D	5/16	1/2-20	\$7.50	\$1.85
6	6D	3/8	9/16-18	\$7.50	\$1.38
8	8D	1/2	3/4-16	\$18.50	\$2.20
10	10D	5/8	7/8-14	\$6.60	\$2.73
12	12D	3/4	1-1/16-12	---	\$4.90



**AN929
CAP, FLARED TUBE FITTING**

Size No.	Tube O.D.	Thread Size	Price
2	1/8	5/16-24	\$1.97
3	3/16	3/8-24	\$2.24
4	1/4	7/16-20	\$1.96
5	5/16	1/2-20	\$2.15
6	3/8	9/16-18	\$2.22
8	1/2	3/4-16	\$3.85
10	5/8	7/8-14	\$5.35
12	3/4	1-1/16-12	\$7.50
16	1	1-5/16-12	\$11.50

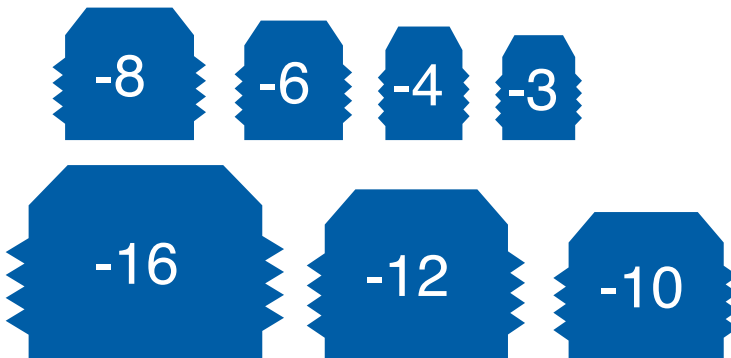

AN Size	Metal Tube O.D.	Thread Size
2	1/8	5/16-24 SAE
3	3/16	3/8-24 SAE
4	1/4	7/16-20 SAE
5	5/16	1/2-20 SAE
6	3/8	9/16-18 SAE
8	1/2	3/4-16 SAE
10	5/8	7/8-14 SAE
12	3/4	1-1/16-12 SAE
16	1"	1-5/16-12 SAE

NPT FITTING SIZES

Pipe Thread Size	Threads per inch	Theoretical I.D. of Fitting	Closest AN Fitting Size	Nominal Size	Actual Diameter
1/16"	27	1/16"			
1/8"	27	1/8"	4	1/8"	.405
1/4"	18	1/4"	6	1/4"	.540
3/8"	18	3/8"	8	3/8"	.675
1/2"	14	1/2"	10	1/2"	.840
3/4"	14	3/4"	12		
1"	11.5	1"	16		
1-1/4"	11.5	1-1/4"	20		
1-1/2"	11.5	1-1/2"	24		
2"	11.5	2"			

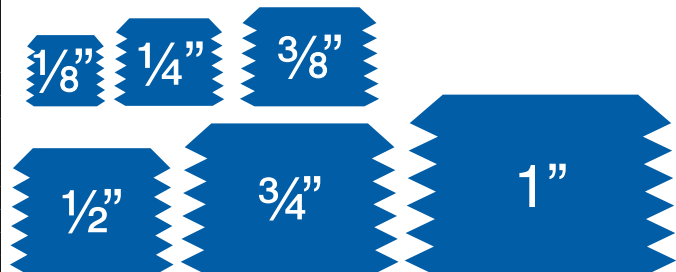

DIAGRAMS MAY NOT BE ACCURATE AND SHOULD NOT BE USED FOR EXACT SIZING. FOR REFERENCE ONLY

PHENIX FITTINGS

ALUMINUM MANIFOLD FITTINGS

ORDERING INFORMATION

Basic part number on all fittings is 04-00XXX, complete the part number by filling in the last 3 digits after selecting the fitting you need according to the details below. Example: 04-00102.

First Code Number - Determines the style of the fitting.

- 1: One port in the end with two ports out, 90° cross drilled with one port per side. 3 ports total. Two Mounting Holes.
- 2: One port in the end with four ports out, 90° cross drilled with two ports per side. 5 ports total. Two Mounting Holes.
- 3: One port in the end with six ports out, 90° cross drilled with three ports per side. 7 ports total. Four Mounting Holes.
- 4: One port in the end with eight ports out, 90° cross drilled with four ports per side. 9 ports total. Four Mounting Holes.
- 5: One port in the end with four ports out, 90° drilling with four ports on one side only. 5 ports total. Two Mounting Holes.

Second Code Number - Determines the style of porting.

- 0: All the ports are the same.
- 1: Inlet port is one size larger than outlet ports.
- 2: Inlet port is two sizes larger than outlet ports.

Third Code Number - Determines the inlet port size.

- 2: 1/8-27 taper pipe thread (NPT)
- 4: 1/4-18 taper pipe thread (NPT)
- 6: 3/8-18 taper pipe thread (NPT)
- 8: 1/2-14 taper pipe thread (NPT)

In the example above - 04-00102, this would be a 1/8 NPT inlet with two outlets of the same size.

Ex.-04-00326, this would have a 3/8 NPT inlet w/six 1/8 NPT outlets.



Our aluminum manifold fittings are a bolt-on design with taper pipe threads. These fittings are designed to provide a convenient means of plumbing multiple hoses from and/or to one source with the fitting being bolted to a supporting structure. This design will eliminate Adel clamps at the juncture of the hoses and eliminate additional tee type fittings when more than two hoses are to be connected to one source. Applications include brake reservoir lines, static system, suction systems, fuel systems, air line pigs, smoke systems, and more. Not for use on oxygen systems or pressures over 150 psi.

Part No.	Price	Part No.	Price	Part No.	Price
04-00102	\$20.50	04-21600	\$36.85	04-00402	\$41.50
04-00104	\$24.50	04-21800	\$45.70	04-00404	\$47.90
04-00106	\$25.95	04-00226	\$34.65	04-00414	\$46.50
04-00108	\$32.60	04-00228	\$40.60	04-00416	\$60.75
04-00114	\$19.50	04-00302	\$32.85	04-00426	\$53.75
04-00116	\$24.75	04-00304	\$42.65	04-00428	\$61.75
04-00118	\$28.50	04-00306	\$52.75	04-00502	\$27.50
04-00126	\$21.90	04-00308	\$61.90	04-00504	\$36.85
04-00128	\$28.50	04-00314	\$34.65	04-00514	\$32.50
04-00202	\$24.50	04-00316	\$47.85	04-00516	\$43.50
04-00204	\$31.60	04-00318	\$53.75	04-00526	\$39.50
04-00206	\$40.50	04-00326	\$48.95	04-00528	\$49.95
04-00214	\$26.95	04-00328	\$54.90		

HA

PRIMER FITTINGS

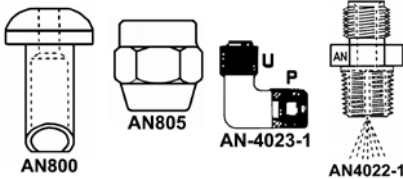

P=1/8 PIPE THREADS

U=5/16-32 UNION THREADS

AN No.	Description	Thread	Price
AN780-2	Union Nipple	1/8x5/16-32	\$5.35
AN800-2	Union Cone	--	\$1.40
AN800-2C-SS	Union Cone	--	\$23.55
AN805-2	Union Nut	5/16-32	\$1.45
AN4022-1	Discharge Nipple	1/8x5/16-32	\$30.65
AN4023-1	Discharge Elbow New Surplus	1/8x5/16-32	\$13.50

New Surplus Primer Elbow Fitting P/N 04-02162 \$13.50

Light weight aluminum adapters by Phenix Industries are designed for leak-proof sealing with any manufacturers hose ends. Made in USA.

PHENIX FEMALE TO FLARE EXPANDERS AND REDUCERS

Phenix Part No.	Female / Male	Part No.	Price
C46-4	-4 / -6	04-02102	\$7.50
C68-4	-6 / -8	04-02101	\$9.55
C810-4	-8 / 10	04-02103	\$11.90
C1012-4	-10 / -12	04-02104	\$16.50
C1216-4	-12 / -16	04-02105	\$19.60

PHENIX FEMALE TO FLARE EXPANDERS AND REDUCERS - BLUE

Phenix Part No.	Female / Male	Part No.	Price
C431-4	-4 / -3	04-02094	\$7.65
C64-4	-6 / -4	04-02095	\$7.55
C86-4	-8 / -6	04-02096	\$9.50
C106-4	-10 / -6	04-02097	\$14.50
C108-4	-10 / -8	04-02098	\$15.95
C1210-4	-12 / -10	04-02099	\$20.95

PHENIX 90 DEGREE SWIVEL FEMALE TO MALE - BLUE

Phenix Part No.	Female / Male	Part No.	Price
C0647-4	-6 / -6	04-02113	\$15.50
C0847-4	-8 / -8	04-02114	\$24.50

PHENIX 45° SWIVEL FORGED ELBOW FEMALE TO MALE - BLUE

Phenix Part No.	Size	Part No.	Price
C0345-4	-3	04-04082	\$13.50
C0445-4	-4	04-04083	\$13.50
C0645-4	-6	04-04051	\$15.95
C0845-4	-8	04-04084	\$24.50
C01045-4	-10	04-04085	\$30.70
C01245-4	-12	04-04086	\$35.50

PHENIX STRAIGHT SWIVEL FEMALE TO MALE NPT - BLUE

Phenix Part No.	AN	NPT	Part No.	Price
C1451-4	-4	1/8"	04-02139	\$8.80
C1651-4	-6	1/4"	04-02140	\$10.65
C1652-4	-6	3/8"	04-02141	\$11.70
C1851-4	-8	3/8"	04-02142	\$11.85
C1852-4	-8	1/2"	04-02143	\$14.50
C11051-4	-10	1/2"	04-02144	\$14.50

PHENIX SWIVEL COUPLER STRAIGHT - BLUE

Phenix Part No.	Female / Male	Part No.	Price
C6-4	-6	04-02145	\$8.50
C8-4	-8	04-02146	\$9.50
C10-4	-10	04-02147	\$11.70
C12-4	-12	04-02148	\$16.50
C1210-4	-12 / -10	04-02099	\$20.95

PHENIX 45 DEGREE SWIVEL COUPLER - BLUE

Phenix Part No.	Female / Male	Part No.	Price
C645-4	-6 / -6	04-02135	\$13.55
C845-4	-8 / -8	04-02136	\$17.55
C1405-2	-10 / -10	04-03815	\$19.60
C1245-2	-12 / -10	04-03818	\$21.65

PHENIX 90° SWIVEL COUPLER - BLUE AND RED

Phenix Part No.	Size	Part No.	Price
C690-2	-6	04-03802	\$13.80
C1090-2	-10	04-03801	\$19.95
C1290-2	-12	04-03819	\$21.65

PHENIX COMPRESSION FITTINGS

Phenix compression swivel hose ends are constructed from lightweight 6061 aluminum and designed for smooth flow, easy assembly, and longer life. All elbow ends are built from one-piece billet tube construction, avoiding leakable braze joints. O-ring seals allow 360 degree rotation. 37 degree AN flare assures leak proof sealing surface, eliminating need for taping. Compatible with all AN adapter fittings. Made in USA.



**PHENIX STRAIGHT
PUSH-LOK - RED/BLUE**

Phenix Part No.	Size	Part No.	Price
J2400-2	AN-4	04-02120	\$4.95
J2600-2	AN-6	04-02121	\$4.95
J3800-2	AN-8	04-03804	\$6.50
J31000-2	AN-10	04-03805	\$8.50
J31200-2	AN-12	04-03806	\$10.95



**PHENIX 90°
PUSH-LOK - RED/BLUE**

Phenix Part No.	Size	Part No.	Price
J3490-2	AN-4	04-03812	\$14.50
J3690-2	AN-6	04-03799	\$15.50
J2890-2	AN-8	04-02132	\$17.50
J21290-2	AN-12	04-02134	\$20.55



**PHENIX COMPRESSION
SWIVEL HOSE END
STRAIGHT**

Size	Color	Part No.	Price
AN-4	Blue/red	04-03602	\$6.55
AN-6	Blue/red	04-03603	\$7.75
AN-8	Blue/red	04-03604	\$9.95
AN-10	Blue/red	04-03605	\$12.50
AN-12	Blue/red	04-03606	\$17.50
AN-4	Black	04-03629	\$6.50
AN-6	Black	04-03630	\$8.50
AN-8	Black	04-03631	\$9.70
AN-10	Black	04-03632	\$12.50
AN-12	Black	04-03633	\$17.50



**PHENIX COMPRESSION
SWIVEL HOSE END - 150°**

Color	Size	Part No.	Price
Blue/Red	AN-6	04-03621	\$26.50
Blue/Red	AN-8	04-03622	\$28.80
Blue/Red	AN-10	04-03623	\$33.90
Blue/Red	AN-12	04-03624	\$37.50
Black	AN-6	04-03648	\$26.50
Black	AN-8	04-03649	\$28.80
Black	AN-10	04-03650	\$33.90
Black	AN-12	04-03651	\$37.50



**PHENIX PUSH-ON SWIVEL
HOSE END - 45°**

Size	Color	Part No.	Price
AN-8	Blue/red	04-02127	\$17.75
AN-12	Blue/red	04-03820	\$23.90



**PHENIX COMPRESSION
SWIVEL HOSE END - 45°**

Color	Size	Part No.	Price
Blue/Red	AN-4	04-03607	\$17.95
Blue/Red	AN-6	04-03608	\$18.65
Blue/Red	AN-8	04-03609	\$21.65
Blue/Red	AN-10	04-03610	\$25.55
Blue/Red	AN-12	04-03611	\$27.50
Black	AN-4	04-03634	\$18.50
Black	AN-6	04-03635	\$18.50
Black	AN-8	04-03636	\$21.50
Black	AN-10	04-03637	\$25.50
Black	AN-12	04-03638	\$27.50



**PHENIX COMPRESSION
SWIVEL HOSE END - 90°**

Color	Size	Part No.	Price
Blue/Red	AN-4	04-03612	\$18.55
Blue/Red	AN-6	04-03613	\$18.65
Blue/Red	AN-8	04-03614	\$21.65
Blue/Red	AN-10	04-03615	\$25.55
Blue/Red	AN-12	04-03616	\$26.50
Black	AN-4	04-03639	\$18.50
Black	AN-6	04-03640	\$18.65
Black	AN-8	04-03641	\$21.65
Black	AN-10	04-03642	\$25.50
Black	AN-12	04-03643	\$26.50



**PHENIX COMPRESSION
SWIVEL HOSE END - 120°**

Color	Size	Part No.	Price
Blue/Red	AN-6	04-03617	\$26.55
Blue/Red	AN-8	04-03618	\$28.80
Blue/Red	AN-10	04-03619	\$33.90
Blue/Red	AN-12	04-03620	\$37.50
Black	AN-6	04-03644	\$26.50
Black	AN-8	04-03645	\$28.80
Black	AN-10	04-03646	\$33.90
Black	AN-12	04-03647	\$37.50



**PHENIX COMPRESSION
SWIVEL HOSE END - 180°**

Color	Size	Part No.	Price
Blue/Red	AN-6	04-03625	\$26.60
Blue/Red	AN-8	04-03626	\$28.60
Blue/Red	AN-10	04-03627	\$33.50
Blue/Red	AN-12	04-03628	\$37.50
Black	AN-6	04-03652	\$26.50
Black	AN-8	04-03653	\$28.80
Black	AN-10	04-03654	\$33.50
Black	AN-12	04-03655	\$37.50

SEE OUR WEBSITE FOR MORE PHENIX FITTINGS

PHENIX FITTINGS

PHENIX BLACK BRAIDED HOSE



A lightweight alternative to standard double braided stainless hose. This hose is constructed of a high grade CPE (Chlorinated Polyethylene) inner core surrounded by lightweight stainless center braid and a tightly woven black nylon outer braid. This combination creates superior strength and is lightweight. This hose is not recommended for high vacuum applications with using an inner spring support. Quantities are sold by the foot.

Model	Color	Part No.	Price
AN-4	Black	04-03661	\$7.50
AN-6	Black	04-03662	\$8.50
AN-8	Black	04-03663	\$10.55
AN-10	Black	04-03664	\$13.75

PHENIX DOUBLE BRAIDED STAINLESS STEEL HOSE



Phenix Hose products have been tested through independent ASTM laboratories to meet all SAE-30R7 standards. These stainless braided hose products were designed for easier assembly by the end user, plus limited wire frays and spreads which occur after cutting. Hoses are engineered

to be dimensionally consistent and easier to assemble with re-usable fittings. The enhanced curing process of the hose uniformly applies the glue and adhesion of glue between the stainless braid and the CPE inner core. This dramatically reduces the frays and spreads associated with cut stainless braided hose products. Operating temperatures are from -40 degrees to +350 degrees F and deliver hydrocarbon and alcohol based fuels, motor oils, and coolant. Quantities are sold by the foot. For AN adapter fittings. Made in USA

Model	Color	Part No.	Price
AN-4	Stainless Steel	04-03656	\$6.95
AN-6	Stainless Steel	04-03657	\$8.50
AN-8	Stainless Steel	04-03658	\$9.50
AN-10	Stainless Steel	04-03659	\$9.80
AN-12	Stainless Steel	04-03660	\$10.95

PHENIX PUSH ON HOSES



Designed for reduced weight and increased flexibility, Phenix Push-On Hose features a Class A high oil resistant nitrile inner tube with a reinforcing two spiral aramid fiber and a nitrile/PVC cover resistant to oil and petroleum based products. Our Push-On hose is compatible with a wide range of oils and fuels, however is NOT recommended for use with unleaded gasoline. DO NOT USE with brake fluids or power steering fluids. Operates at 250 PSI and temperature range -30 degrees to +160 degrees F. Use with Push-Lok swivel hose ends.

Key Features:

- Operates at 250 PSI
- Temperature Range: -30 Deg to +160 Deg f
- Compatible with Push-Lok Swivel Hose Ends

Model	Color	Part No.	Price
K204-3	Black	04-03786	\$5.35
K206-3	Black	04-03787	\$6.50
K208-3	Black	04-03788	\$6.95
K210-3	Black	04-03789	\$11.75
K212-3	Black	04-03790	\$12.85

DEL 37° FITTING SEALS



DEL fitting seals are designed to eliminate leakage due to scratches on the sealing surface, improper torquing, or poor finishes on tube ends, in high or low pressure applications. For use with AN, MS, and JIC 37° flared fittings, DEL fitting seals also reduce tube flare cracking by reducing

torque needed, eliminating nose damage to the fitting, and allow reuse of hardware. Approved by NASA, SAE, Air Force, Army, Navy, and major aerospace contractors.

Aluminum			
Part Number	Tube Size OD	Fitting Dash Size	Price Each
04-05002	1/8	2	\$1.75
04-05003	3/16	3	\$1.75
04-05004	1/4	4	\$1.75
04-05006	3/8	6	\$1.75
04-05008	1/2	8	\$1.75
04-05010	5/8	10	\$1.75
04-05012	3/4	12	\$1.75
04-05016	1	16	\$1.75
Copper			
08-13471	1/4"	4	\$1.75
08-13472	3/8"	6	\$1.75

HA

PARKER STAT-O-SEAL NAS1523



The NAS 1523 Stat-O-Seal is designed with a pre-calculated interference factor built into the teardrop shaped elastomeric seal designed for applications requiring NAS 1523 conformance. The cross-section free height of the rubber is greater than the metal retainer, providing the proper compression without squeezing the seal beyond its elastic limit.

NAS 1523 Stat-O-Seal Features:

Parker NAS 1523 Stat-O-Seals are one-piece, molded-in-place seals with the rubber sealing element mechanically and/or chemically bonded to the metal retainer. Parker's "Splined and Coined" mechanical bonding feature is used on many 600, NAS1523 and 610 series sizes. This feature ensures a positive attachment of the rubber to the retainer, eliminating missing or loose seal elements associated with bonded seals. Stat-O-Seals are designed to seal beneath the head of the fastener as shown for both internal and external pressure and vacuum systems.

NAS 1523 Stat-O-Seals offer users long and reliable service, a high degree of reusability and easy assembly.

Description	Fastener Size	I.D.	O.D.	Part Number	Price
NAS1523-4B	1/4"	.240	.500	05-14983	\$4.35
NAS1523-8B	1/2"	.490	.875	05-12626	\$3.55

SEE OUR WEBSITE FOR MORE PHENIX FITTINGS

WWW.AIRCRAFTSPRUCE.COM

CAPPLUGS

T SERIES CAPPLUGS (NON-THREADED)



Recommended closure for tube & hydraulic fittings.

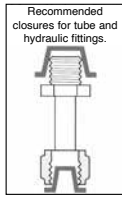

Recommended closures for tube and hydraulic fittings.

Tapered Capplugs can be used as either caps or plugs. Because they are tapered in design and made from highly pliable (or flexible) Polyethylene, they can be applied to fit snugly and are readily removable, whether used for capping or plugging. Especially recommended for use on MIL Std. and SAE-type tube and hydraulic fittings and for threaded external and internal NPT fittings.

Part No.	Dash No.	Tubing O.D.	Thread	Caplugs As Plugs	Caplugs As Caps	Price Each
04-00045	-2	1/8	5/16-24	1	2	\$0.40
04-00046	-3	3/16	3/8-24	2	3-X	\$0.21
04-00047	-4	1/4	7/16-20	3	4-X	\$0.29
04-00048	-5	5/16	1/2-20	4	5	\$0.32
04-00049	-6	3/8	9/16-18	5	6-X	\$0.29
04-00050	-8	1/2	3/4-16	8	9-X	\$0.29
04-00051	-10	5/8	7/8-14	10	11-X	\$0.31
04-00052	-12	3/4	1 1/16-12	12-X	13-X	\$0.29
04-00053	-16	1	1 5/16-12	14-X	15-X	\$0.57

Less 20% Discount on 50 Caplugs (Same P/N)

SC SERIES CAPPLUGS (NON-THREADED)



Series SC sleeve caps are designed to fit outside diameters of tubing sizes listed with a snug friction grip. Available in 57 different O.D.'s and lengths. Ideal for capping and protecting both threaded and non-threaded tubing or rod ends. They also make excellent masks, for painting, plating or grit-blasting operations.

Part No.	Caplug No.	A		B		Price Ea.
		To fit tube O.D.	Inside Length	Inches	mm	
04-00054	SC-1/8	1/8	3.18	.59	14.99	\$0.25
04-00055	SC-3/16-5	3/16	4.76	.35	8.89	\$0.25
04-00056	SC-3/16-16	3/16	4.76	1.00	25.40	\$0.28
04-00057	SC-1/4-4	1/4	6.35	.22	5.59	\$0.28
04-00058	SC-1/4-14	1/4	6.35	.88	22.35	\$0.29
04-00059	SC-5/16	5/16	7.94	.88	22.35	\$0.24
04-00060	SC-3/8	3/8	9.53	.88	22.35	\$0.32
04-00061	SC-7/16-14	7/16	11.11	.88	22.35	\$0.32
04-00062	SC-1/2-8	1/2	12.70	.50	12.70	\$0.31
04-00063	SC-1/2-14	1/2	12.70	.88	22.35	\$0.30
04-00064	SC-9/16-9	9/16	14.29	.56	14.22	\$0.34
04-00065	SC-9/16-14	9/16	14.29	.88	22.35	\$0.57
04-00066	SC-5/8	5/8	15.88	.88	22.35	\$0.31
04-00067	SC-3/4	3/4	19.05	.88	22.35	\$0.36
04-00068	SC-7/8	7/8	22.23	.88	22.35	\$0.38
04-00069	SC-1	1	25.40	1.00	25.40	\$0.46

Less 20% Discount on 50 Caplugs (Same P/N)

CD SERIES CAPPLUGS (THREADED)



Series CD caps seal flared JIC fittings exceptionally well against dirt and moisture, as well as for masking during dipping, painting and plating.

Less 20% Discount on 50 Caplugs (Same P/N)

Part No.	Caplug No.	To Cap Normal Tubing Size	To fit Thread	Dim A		No. of Knurls	Price Each
				In	mm		
04-00032	CD-3	3/16"	3/8-24	.47	11.94	4	\$0.15
04-00033	CD-4	1/4"	7/16-20	.47	11.94	4	\$0.13
04-00034	CD-5	5/16"	1/2-20	.47	11.94	6	\$0.14
04-00035	CD-6	3/8"	9/16-18	.53	13.46	6	\$0.15
04-00036	CD-6A	3/8"	5/8-18	.53	13.46	6	\$0.16
04-00037	CD-8	1/2"	3/4-16	.57	14.48	6	\$0.18
04-00038	CD-10	5/8"	7/8-14	.68	17.27	6	\$0.18
04-00039	CD-11	-	1-14	.78	19.81	8	\$0.20
04-00040	CD-12	3/4"	1 1/16-12	.75	19.05	8	\$0.20

PD SERIES CAPPLUGS (THREADED)



Series PD Plugs, designed for use on flared JIC fittings, air knurled for ease of application. They will seal low pressure requirements with light finger tightening. PD plugs can be used to seal 37° flare fittings without gaskets.

Less 20% Discount on 50 Caplugs (Same P/N)

Part No.	Caplug No.	To Plug Nominal Tubing Size	To fit Thread	Dimensions						Price Each	
				B		C		D			
				in	mm	in	mm	in	mm		
04-03007	PD-20	1/8	5/16-24	.44	11.18	.44	11.18	.18	4.57		\$0.14
04-00023	PD-30	3/16	3/8-24	.46	11.68	.50	12.70	.18	4.57		\$0.16
04-00024	PD-40	1/4	7/16-20	.53	13.46	.62	15.75	.19	4.83		\$0.19
04-00025	PD-50	5/16	1/2-20	.53	13.46	.68	17.27	.25	6.35		\$0.19
04-00026	PD-60	3/8	9/16-18	.50	12.70	.81	20.57	.25	6.35		\$0.16
04-00027	PD-65	3/8	5/8-18	.59	14.99	.81	20.57	.25	6.35		\$0.15
04-00028	PD-80	1/2	3/4-16	.75	19.05	.94	23.88	.25	6.35		\$0.20
04-00029	PD-100	5/8	7/8-14	.87	22.10	1.06	26.93	.25	6.35		\$0.22
04-03526	PD-120	3/4	1 1/16-12	.89	22.61	1.25	31.75	.25	6.35		\$0.52
04-00030	PD-121	3/4	1-1/16-14	1.12	28.45	1.31	33.28	.25	6.35		\$0.22
04-04063	PD-HF-32 LDPE	2	2-1/2-12	1.31	33.27	3.09	78.49	.38	9.65		\$1.80
04-00031	PD-160	1	1-5/16-12	.93	23.62	1.50	38.10	.25	6.35		\$0.25

PDE SERIES CAP PLUGS (THREADED)

PDE Series threaded plugs are designed to fit tube and nut assemblies interchangeably. Knurled to aid with finger tightening installation and removal.

Part No.	Caplug No.	To Fit Thread	Dimensions				Price Each		
			B		C				
				in	mm	in	mm		
04-04061	PDE-4	7/16-20	0.40	10.16	0.56	14.22			\$0.16
04-04062	PDE-6	9/16-18	0.48	12.192	0.68	17.27			\$0.28

Less 20% Discount on 50 Caplugs (Same P/N)

HA

CAPPLUGS

RCL SERIES CAPPLUGS (UNTHREADED)

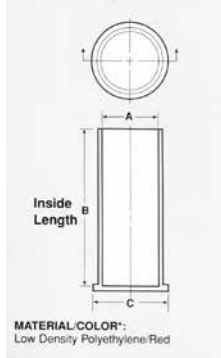

Series RCL caps are ideal for protecting threaded or smooth cylindrical surfaces. Originally designed for use on hydraulic double threaded bulkhead fittings, they are especially suitable where greater longitudinal protection is required.

Less 20% Discount on 50 Capplugs (Same P/N)

Part No.	Caplug No. (formerly) (series B-203)	A To Cap Thread Size In.	B Inside Length		C		Price Each
			In	mm	in	mm	
04-00079	RCL-2	5/16	1.24	31.50	.46	11.68	\$0.30
04-00080	RCL-3	3/8	1.24	31.50	.52	13.21	\$0.87
04-00009	RCL-4	7/16	1.33	33.78	.58	14.73	\$0.32
04-00011	RCL-5	1/2	1.33	33.78	.64	16.26	\$0.35
04-00012	RCL-6	9/16	1.41	35.82	.70	17.78	\$0.49
04-00013	RCL-8	3/4	1.56	39.63	.88	22.35	\$0.41
04-00014	RCL-9	M-20 (.787)	1.56	39.63	.91	23.11	\$1.16
04-00015	RCL-10	7/8	1.70	43.18	1.01	25.66	\$0.54
04-00016	RCL-12	1 1/16	1.89	48.01	1.19	30.23	\$0.75

HA

EC SERIES CAPPLUGS (UNTHREADED)



Static dissipative EC Series Capplugs provide positive ESD and physical protection for all common sizes of threaded electrical and electronic connectors. Also suitable for protecting non-threaded bayonet-type connectors.

Less 20% Discount on 50 Capplugs (Same P/N)

Part No.	Caplug No.	A-Caps Nominal Thread Size In.	Dimensions				Price Each
			B		C		
			In	mm	in	mm	
04-00070	EC-4	1/4	.48	12.19	.50	12.70	\$0.25
04-00071	EC-5	5/16	.55	13.97	.56	14.22	\$0.26
04-00072	EC-6	3/8	.62	15.75	.50	12.70	\$0.24
04-00073	EC-8	1/2	.74	18.79	.50	12.70	\$0.33
04-00074	EC-9	9/16	.78	19.81	.44	11.18	\$0.13
04-00075	EC-10	5/8	.84	21.34	.50	12.70	\$0.29
04-00076	EC-12	3/4	.97	24.63	.50	12.70	\$0.28
04-00077	EC-14	7/8	1.12	28.44	.50	12.70	\$0.89
04-00078	EC-16	1	1.22	30.98	.50	12.70	\$0.36

P SERIES CAPPLUGS (THREADED)



Series P pipe plug are square head. They are molded in high density polyethylene and are ideal for keeping moisture, dirt and other contaminants from NPT-threaded ports.

Less 20% Discount on 50 Capplugs (Same P/N)

Part No.	Caplug No.	To Fit	Dimensions						Price Each
			A		B		C		
			in	mm	in	mm	in	mm	
04-00041	P-18	1/8" NPT	.44	11.18	.28	7.11	-	-	\$0.20
04-00042	P-28	1/4" NPT	.50	12.70	.37	9.40	-	-	\$0.40
04-00043	P-38	3/8" NPT	.56	14.22	.44	11.18	-	-	\$0.71
04-00044	P-48	1/2" NPT	.59	14.99	.56	14.22	-	-	\$0.58

PDF SERIES CAPPLUGS (THREADED)

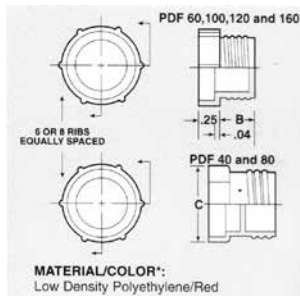

Series PDF plugs are designed for easy mechanical or hand installation on flat-faced O-ring fittings.

Less 20% Discount on 50 Capplugs (Same P/N)

Part No.	Caplug No.	To Plug Nominal Tubing Size	To Fit Thread Size	Dimensions				Price Each
				B		C		
				in	mm	in	mm	
04-00018	PDF-60	3/8"	11/16-16	.44	11.18	.87	22.10	\$0.54
04-00019	PDF-80	1/2"	13/16-16	.50	12.70	.94	23.88	\$0.55
04-00020	PDF-100	5/8"	1-14	.59	14.99	1.16	29.47	\$0.66
04-00021	PDF-120	3/4"	13/16-12	.63	16.00	1.33	33.78	\$0.86
04-00022	PDF-160	1"	17/16-12	.75	19.05	1.63	41.40	\$3.35

NYLO-SEAL FITTINGS

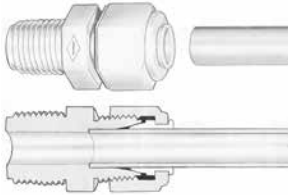

Nylo-Seal tube fittings are exceptionally strong. The bodies, made of nylon, are stronger than machined fittings of similar composition. They are furnished complete with nut/sleeve assemblies, made of acetal copolymer. Since the sleeve snaps into and is retained by the nut there is no fumbling for a loose sleeve. Just insert tube into the fitting and tighten the nut 2 to 2-1/2 full turns.

Note: The most frequently used combination of tube and pipe sizes are 1/4" Tube x 1/8" Pipe and 3/8" Tube x 1/4" Pipe.

259-P CAP, 259-N INSERT (NYLON)

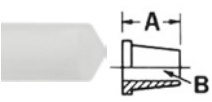

Tube O.D.	A	D	Part No.	Price
1/4	3/8	1/8	259-N04	\$0.60
3/8	3/8	1/8	259-N06	\$0.65
1/4	7/16	13/64	259-P04	\$0.85
3/8	7/16	13/64	259-P06	\$1.30

261-N NUT AND SLEEVE ASSEMBLY

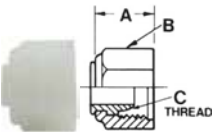

Tube O.D.	Thread	A	C	Part No.	Price
1/4	7/16-20	15/32	9/16	261-N04	\$0.95
3/8	5/8-20	37/64	3/4	261-N06	\$1.40

262-N UNION

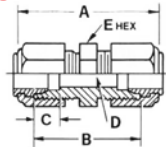

Tube O.D.	A	B	C	D	E	Part No.	Price
1/4	1-25/64	63/64	5/8	7/32	15/32	262-N04	\$2.70
3/8	1-21/32	1-1/4	13/16	23/64	19/32	262-N06	\$3.90

264-N UNION TEE

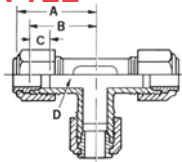

Tube O.D.	A	B	D	E	Part No.	Price
1/4	1-9/64	47/64	7/32	15/32	264-N04	\$4.35
3/8	1-11/64	31/31	11/32	19/32	264-N06	\$6.85

265-N ELBOW UNION

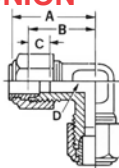

Tube O.D.	A	B	D	E	Part No.	Price
1/4	1-1/64	13/16	7/32	3/8	265-N04	\$3.25
3/8	1-5/32	15/16	11/32	7/16	265-N06	\$5.95

266-N FEMALE CONNECTOR

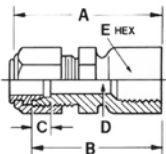

Tube O.D.	Pipe Thread	A	B	C	D	E	Part No.	Price
1/4	1/8	1-9/64	15/16	9/16	7/32	9/16	266-N04X02	\$7.95
1/4	1/4	1-5/16	1-7/64	11/16	7/32	47/64	266-N04X04	\$6.75
3/8	1/4	1-27/64	1-7/32	11/16	11/32	3/4	266-N06X04	\$7.95
3/8	3/8	1-27/64	1-7/32	13/16	11/32	3/4	266-N06X06	\$7.55

268-N MALE CONNECTOR

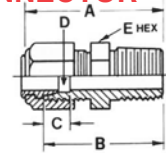

Tube O.D.	Pipe Thread	A	B	C	D	E	Part No.	Price
1/4	1/8	1-13/64	1	5/8	15/64	15/32	268-N04X02	\$2.75
1/4	1/4	1-25/64	1-3/16	5/8	15/64	11/16	268-N04X04	\$2.35
3/8	1/4	1-17/32	1-21/64	13/16	5/16	19/32	268-N06X04	\$3.35
3/8	3/8	1-19/32	1-25/64	13/16	11/32	19/32	268-N06X06	\$2.85

269-N MALE ELBOW

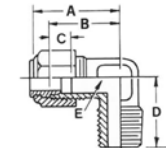

Tube O.D.	Pipe Thread	A	B	D	E	F	Part No.	Price
1/4	1/8	1-1/64	13/16	7/32	3/8	27/32	269-N04x02	\$2.80
1/4	1/4	1-1/64	13/16	13/32	3/8	1-1/32	269-N04x04	\$2.90
3/8	1/4	1-9/64	15/16	5/16	7/16	1-1/32	269-N06x04	\$3.95
3/8	3/8	1-9/64	15/16	11/32	7/16	1-3/32	269-N06x06	\$4.35

271-N MALE RUN TEE

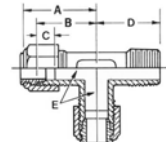

Tube O.D.	Pipe Thread	A	B	D	E	F	Part No.	Price
1/4	1/8	59/64	21/32	7/32	15/32	3/4	271-N04X02	\$3.40
1/4	1/4	59/64	13/32	7/32	15/32	29/32	271-N04X04	\$5.35
3/8	1/4	1-5/32	61/64	5/16	19/32	1-1/16	271-N06X04	\$11.90
3/8	3/8	1-3/16	61/64	23/64	19/32	1-7/64	271-N06X06	\$6.55

272-N MALE BRANCH TEE

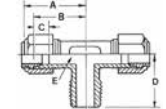

Tube O.D.	Pipe Thread	A	B	D	E	F	Part No.	Price
1/4	1/8	15/16	47/64	7/32	15/32	3/4	272-N04X02	\$3.80
1/4	1/4	15/16	47/64	7/32	15/32	13/16	272-N04X04	\$4.95
3/8	1/4	1-11/64	31/32	5/16	19/32	1-1/16	272-N06X04	\$6.60
3/8	3/8	1-11/64	31/32	23/64	19/32	1-7/64	272-N06X06	\$6.90

282-N BULKHEAD UNION

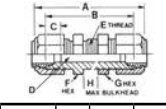

Tube O.D.	Pipe Thread	A	B	C	D	E	F	G	Part No.	Price
1/4	7/16-20	1-57/64	1-31/64	5/8	7/32	15/32	5/8	5/16	282-N04	\$7.65
3/8	5/8-20	2-1/4	1-53/64	13/16	11/32	19/32	7/8	3/8	282-N06	\$8.50

*Use 259-N inserts with all Poly-Flo tubing connections. Not needed with Nylo-Seal tubing.

Less 10% on 50 pieces per size, Less 20% on 100 pieces per size

HA

NYLO-SEAL FITTINGS

MALE NPT NYLON COMPRESSION CONNECTOR

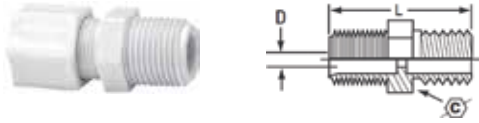

Specifications: • Connection Type A x B: Tube x Male NPT • Nylon • FDA, NSF • Type: Compression Connector • 220 PSI

Tube O.D.	Male Pipe Thread	OEM Part Number	L	D	C	Part Number	Price
1/4	1/8	1568x4G	0.99	0.26	5/8	12-05471	\$1.65
1/4	1/4	1568x4x4G	1.17	0.28	5/8	12-05472	\$2.15
3/8	1/4	1568x6G	1.30	0.38	13/16	12-05473	\$3.55
3/8	3/8	1568x6x6G	1.34	0.38	13/16	12-05474	\$2.75

FEMALE NPT NYLON COMPRESSION CONNECTOR

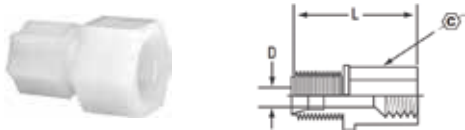

Specifications: • Connection Type A x B: Tube x female NPT • Nylon • FDA, NSF • Gripper Style Nut • Compression Connector • 220 PSI

Tube O.D.	Female Pipe Thread	OEM Part Number	L	D	C	Part Number	Price
1/4	1/8	1566x4G	0.92	0.23	9/16	12-05462	\$3.50
1/4	1/4	1566x4x4G	1.09	0.22	11/16	12-05468	\$5.95
3/8	1/4	1566x6G	1.20	0.36	11/16	12-05469	\$2.95

MALE NPT NYLON COMPRESSION ELBOW

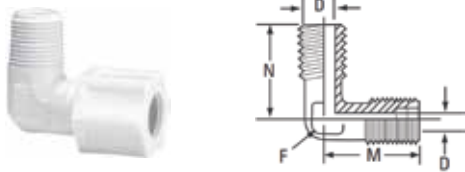

Specifications: Connection Type A x B: Tube x Male NPT • Nylon • SAE • Gripper Style Nut • Compression Elbow • 220 PSI

Tube O.D.	Male Pipe Thread	OEM Part Number	M	N	D	D1	Across Flats(F)	Part Number	Price
1/4	1/8	1569x4G	0.81	0.81	0.22	0.25	3/8	12-05475	\$3.35
1/4	1/4	1569x4x4G	0.81	1.02	0.22	0.28	3/8	12-05476	\$2.75
3/8	1/4	1569x6G	0.94	1.03	0.30	0.31	37/64	12-05477	\$5.80
3/8	3/8	1569x6x6G	0.94	1.09	0.34	0.38	9/16	12-05478	\$3.50

NYLON GRIPPER STYLE NUT COMPRESSION UNION CONNECTOR

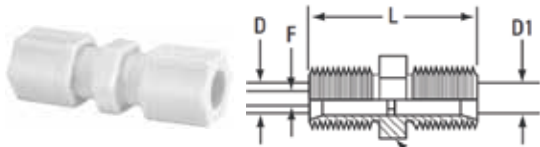

Specifications: For cold and hot water applications • Connection Type A x B: Tube x Tube • Nylon • FDA, NSF • Gripper Style Nut • -40°F - 200°F • Compression Union • 220 PSI

Tube O.D.	OEM Part Number	L	F	C	Part Number	Price
1/4	1562x4G	0.98	0.23	5/8	12-05460	\$2.75
3/8	1562x6	1.23	0.30	13/16	12-05464	\$3.85

NYLON UNION TEE COMPRESSION CONNECTOR

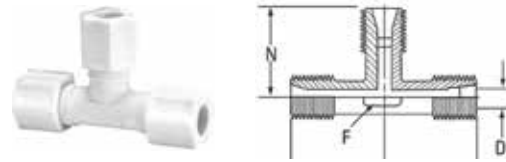

Specifications: For Weatherhead plastic tubing • Connection Type A x B x C: Tube x Tube x Tube • Nylon • Gripper Style Nut • -40°F - 200°F • Type: Union Tee • Working Pressure: 50 PSI

Tube O.D.	OEM Part Number	L	D	N	Across Flats(F)	Part Number	Price
1/4	1564x4G	1.44	0.22	0.72	23/64	12-05461	\$4.35
3/8	1564x6G	1.91	0.30	0.97	17/32	12-05465	\$7.50

1/4" TUBE, 1/4" MALE NPT NYLON BRANCH TEE GRIPPER NUT



Specifications: • Connection Type A x B x C: Tube x Tube x Male NPT • Nylon • FDA, NSF • Gripper Style Nut • Branch Tee • 50 PSI

Tube O.D.	Male Pipe Thread	OEM Part Number	L	D	N	D1	Across Flats(F)	Part Number	Price
1/4	1/4	1572X5G	1.61	0.30	0.98	0.31	27/64	12-05479	\$4.90

UNION ELBOW NYLON COMPRESSION CONNECTOR

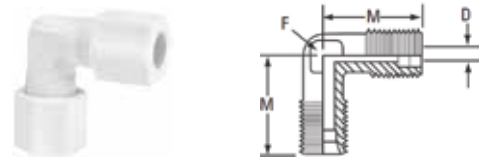

Specifications: • Angle: 90° • Connection Type A x B: Tube x Tube • Nylon • SAE • Gripper Style Nut • Compression Union Elbow • 220 PSI

Tube O.D.	OEM Part No.	M	D	Across Flats(F)	Part No.	Price
1/4	1565X4G	0.81	0.22	3/8	12-05466	\$3.50
3/8	1565X6G	0.94	0.34	9/16	12-05467	\$5.35

NYLON GRIPPER STYLE NUT COMPRESSION UNION CONNECTOR



Specifications: • Connection Type A x B: Tube x Tube • Nylon • FDA, NSF • Gripper Style Nut • -40°F - 200°F • Compression Union • 220 PSI

Tube O.D.	OEM Part Number	C	L	D	Part No.	Price
1/4	1561X4G	5/8	0.69	0.26	12-05459	\$2.25
3/8	1561X6G	13/16	0.73	0.38	12-05463	\$1.65

HA

HOSE FITTINGS – PIPE FITTINGS

HOSE & TUBING FITTINGS



Hose and tubing Insert Fittings are available in high density black polyethylene or white Nylon. Use polyethylene fittings with Tygon, nylon or soft rubber tubing to assemble low pressure instrument lines such as airspeed pitot and static lines. Use Nylon fittings in gravity-feed fuel lines and engine breather lines.

Fitting Type	Size	Polyethylene		Nylon	
		Part No.	Price Each	Part No.	Price Each
Adapter Tube To Pipe	3/16Tx1/8P	0700-150	\$1.10	0701-150	\$1.75
	1/4Tx1/8P	0700-153	\$3.35	0701-153	\$1.15
	5/16Tx1/8P	0700-156	\$1.10	0701T-15	\$1.15
	3/8Tx1/8P	0700-158	\$4.95	0701-158	\$1.25
	1/4Tx1/4P	0700-110	\$2.20	0701-110	\$1.60
Elbow Tube To Pipe	3/8Tx1/4P	0700-162	\$3.85	0701-162	\$0.70
	1/4Tx1/8P	0710-153	\$1.25	0711-153	\$1.35
	3/8Tx1/8P	0710-158	\$2.15	0711-158	\$1.60
	1/4Tx1/4P	0710-110	\$2.15	0711-110	\$2.20
Tube To Tube	3/8Tx1/4P	0710-162	\$2.55	0711-162	\$1.95
	1/4Tx1/4T	0710-015	\$1.40	0711-015	\$1.75
	3/8Tx3/8T	0710-020	\$1.95	0711-020	\$1.65
Reducing Connector	1/4Px1/8P	0725-153	---	0726-153	\$0.96
	3/8Px1/8P	0725-161	\$1.15	0726-161	\$1.05
	3/8Px1/4P	0725-162	\$1.10	0726-162	\$0.95
Tee Tube To Pipe	1/4Tx1/4Tx1/8P	0715-153	\$2.95	0716-153	\$2.10
	3/8Tx3/8Tx1/4P	0715-162	\$2.10	0716-162	\$2.35
	1/4Tx1/4Tx1/4P	0715-110	\$3.35	0716-110	\$1.95
Tee All Tube	3/16Tx3/16Tx3/16T	0715-011	\$2.15	0716-011	\$2.10
	1/4Tx1/4Tx1/4T	0715-015	\$2.10	0716-015	\$2.10
	3/8Tx3/8Tx3/8T	0715-020	\$2.90	0716-020	\$1.65
Connector Tube To Tube	1/4Tx1/4T	0705-015	\$1.20	0706-015	\$1.10
	3/8Tx3/8T	0705-020	\$2.82	0706-020	\$1.45

Fitting Type	Size	Part No.	Price
TEE Tube to pipe HDPE Natural	3/8x3/8x1/4	0715-162	\$2.10



TEE CONNECTOR

For pressure switches with 1/8" male pipe threads. For 1/4" O.D oil pressure lines P/N 10-04846\$11.50



HERBIE CLIP HOSE CLAMPS

The Herbie Clip hose clamp is the original double toothed (double row of teeth) ratchet clamp. This makes the Herbie clip twice as strong (up to 200psi depending on hose work and spigot) as similar hose clamps with a single row of teeth. The Herbie Clip hose clamp combines its high strength with other key features such as: non-corrosive and resistant to many chemicals, simple to install can be fitted before or after the hose is in place, minimum leak path, lightweight, easy to use (no sharp edges to cut the operators), fully compliant with ROHS, UL listed (nylon 6.6.)

Clip Size	Min Dia. (in.)	Max Dia. (in.)	Part No.	Price
A	.22	.26	05-02698	\$0.33
AA	.26	.31	05-02699	\$0.43
B	.31	.36	05-02701	\$0.42
C	.40	.47	05-02702	\$0.35
CC	.44	.51	05-02695	\$0.23
D	.47	.54	05-02703	\$0.39
E	.52	.59	05-02704	\$0.44
F	.59	.67	05-02705	\$0.55
G	.67	.75	05-02706	\$0.41
H	.71	.81	05-02696	\$0.54
J	.80	.91	05-02707	\$0.45
K	.87	.98	05-02708	\$0.56

HERBIE CLIP HOSE CLAMP TOOLS



INSTALLATION TOOL

Recommended for medium volume use. Fits sizes A to K. P/N 05-02709\$271.95

REMOVAL TOOL

It is easy to install and remove using a choice of manual. P/N 05-02710\$20.80

WEATHERHEAD BRASS PIPE FITTINGS

These brass elbows and tees provide flexibility in the routing of lines which terminate in male pipe threads.



45° STREET ELBOW

Part Number	Pipe Thread	Price Each	Part Number	Pipe Thread	Price Each	Part Number	Pipe Thread	Price Each
3350x2	1/8	\$2.75	3350x4	1/4	\$5.35	3350x6	3/8	\$7.85

90° STREET ELBOW

Part Number	Pipe Thread	Price Each	Part Number	Pipe Thread	Price Each	Part Number	Pipe Thread	Price Each
3400x2	1/8	\$3.35	3400x4	1/4	\$5.85	3400x6	3/8	\$6.50

MALE BRANCH TEE

Part Number	Pipe Thread	Price Each	Part Number	Pipe Thread	Price Each	Part Number	Pipe Thread	Price Each
3600x2	1/8	\$3.95	3600x4	1/4	\$3.95	3600x6	3/8	\$9.55

STREET TEE

Part Number	Pipe Thread	Price Each	Part Number	Pipe Thread	Price Each	Part Number	Pipe Thread	Price Each
3750x2	1/8	\$3.55	3750x4	1/4	\$7.50	3750x6	3/8	\$9.50

WEATHERHEAD BRASS FITTINGS

Part No.	Description	Size	Price Each
2030-4	Tube Insert*	1/8ODx3/32ID	\$1.15
3220x4x2	Bushing	1/8FPx1/4MP	\$1.10
6100x2	Nut	1/8T	\$0.95
6200x2	Male Connector	1/8Tx1/8P	\$1.75
66x2	Female Connector	1/8Tx1/8P	\$2.95

* Used for Long-EZ brake fittings.

WEATHERHEAD BARB-TITE REUSABLE HOSE ENDS

Designed for use with hoses with maximum working pressure up to 250 PSI. Easy to assemble and disassemble.

Part No.	Description	Hose I.D.	Pipe Size	Cut-off Factor	Price Each
10006B-104	---	3/8"	1/4"	1-1/2	\$4.35
10008B-108	Straight Pipe	1/2"	1/2"	1.19	\$8.50
10006B-C02	90° Pipe	3/8"	1/8"	3/8	\$8.90
10006B-C04	---	3/8"	1/4"	3/8	\$15.70

BRASS TUBE FITTINGS

Description	Part No.	Price
Brass Tube Fitting 3/8" Pipe x 3/8"	04-00833	\$4.45
Brass Tube Fitting 1/4" Pipe x 3/8"	04-00834	\$3.35

ALL TUBE COMPRESSION TEE FITTING

Includes nuts and compression ferrules for use on 3/16. P/N 15-06175\$3.95

BRASS COMPRESSION NUT 3/16"
P/N 15-04806\$0.45

STRAIGHT TUBE TO MALE NPT ADAPTER

Straight Tube To Male NPT Adapter. Includes compression ferrule for use with 3/16 nylon brake tubing. P/N 15-05526\$1.25

90 DEGREE COMPRESSION TO MALE NPT ELBOW
90 Degree Compression To Male NPT Elbow. Includes compression ferrule for use with 3/16 nylon brake tubing. P/N 15-05525\$2.65

TANK FITTING NPT
Hose Barb X Male Pipe. 1/4"x1/4".... P/N 15-06132\$1.45

FUEL LINE AND PRIMER LINE T FITTING

1/4 x 1/4 x 1/8. Made of delrin P/N 10-01596\$1.95

HOSE FITTINGS

BRASS POLY-FLO FITTINGS

Poly-Flo Flareless tube fittings consist of a brass body, nut and sleeves. Use with PolyFlo, PVC or Nylon pressure tubing. The Poly-Flo fittings have the same configuration as Nylo-Seal fittings of the same basic part number.



261UB - NUT WITH SLEEVE			
Tube O.D.	Thread Size	Part Number	Price Each
1/8	5/16-24	261UB-02	\$1.30
3/16	3/8-24	261UB-03	\$1.35
1/4	3/8-24	261UB-04	\$1.25



262P - UNION			
Tube O.D.	Thread Size	Part Number	Price Each
1/8	--	262P-02	\$5.90
3/16	--	262P-03	\$5.45
1/4	--	262P-04	\$4.45



264P - UNION TEE			
Tube O.D.	Thread Size	Part Number	Price Each
3/16	--	264P-03	\$9.60
1/4	--	264P-04	\$8.85



266P - FEMALE CONNECTOR			
Tube O.D.	Pipe Thread	Part Number	Price Each
1/8	1/8	266P-02x02	\$4.40
3/16	1/8	266P-03x02	\$4.40



268P - MALE CONNECTOR			
Tube O.D.	Pipe Thread	Part Number	Price Each
1/8	1/8	268P-02x02	\$2.55
3/16	1/8	268P-03x02	\$4.80
1/4	1/8	268P-04x02	\$2.15



269P - MALE ELBOW			
Tube O.D.	Pipe Thread	Part Number	Price Each
3/16	1/8	269P-03x02	\$6.95
1/4	1/8	269P-04x02	\$2.90



270P - FEMALE ELBOW			
Tube O.D.	Pipe Thread	Part Number	Price Each
3/16	1/8	270P-03x02	\$12.50



272P - MALE BRANCH TEE			
Tube O.D.	Pipe Thread	Part Number	Price Each
3/16	1/8	272P-03X02	\$17.80
1/4	1/8	272P-04X02	\$5.80

SAE FITTINGS

Brass SAE fittings for NSR tubing.



05-12243 05-12244 05-12245

SAE Nut And Sleeve Assemblies For NSR Tubing				
Description	Tube O.D.	Thread Size	Part No.	Price
61SM-02	1/8"	5/16-24	05-12243	\$2.45
61SM-03	3/16"	3/8-24	05-12244	\$2.65
61SM-04	1/4"	7/16-24	05-12245	\$2.10



05-12246 05-12247 05-12248

SAE Union Fittings For NSR Tubing				
Description	Tube O.D.	Thread Size	Part No.	Price
62SM-02	1/8"	--	05-12246	\$3.85
62SM-03	3/16"	--	05-12247	\$3.95
62SM-04	1/4"	--	05-12248	\$5.75



05-12249

05-12250

05-12251

SAE Female Connectors For NSR Tubing				
Description	Tube O.D.	Thread Size	Part No.	Price
66SM-02 X 02	1/8"	1/8" NPT	05-12249	\$4.35
66SM-03 X 02	3/16"	1/8" NPT	05-12250	\$3.95
66SM-04 X 02	1/4"	1/8" NPT	05-12251	\$3.35



05-12252

05-12253

05-12254

SAE Female Connectors For NSK Tubing				
Description	Tube O.D.	Thread Size	Part No.	Price
64SM-02	1/8"	--	05-12252	\$12.50
64SM-03	3/16"	--	05-12253	\$9.50
64SM-04	1/4"	--	05-12254	\$13.50



05-12255

05-12256

05-12257

SAE Male Connectors For NSR Tubing				
Description	Tube O.D.	Thread Size	Part No.	Price
68SM-02 X 02	1/8"	1/8" NPT	05-12255	\$4.35
68SM-03 X 02	3/16"	1/8" NPT	05-12256	\$2.55
68SM-04 X 02	1/4"	1/8" NPT	05-12257	\$2.15



05-12258

05-12259

05-12260

SAE Male Elbows For NSR Tubing				
Description	Tube O.D.	Thread Size	Part No.	Price
69SM-02 X 02	1/8"	1/8" NPT	05-12258	\$3.90
69SM-03 X 02	3/16"	1/8" NPT	05-12259	\$4.95
69SM-04 X 02	1/4"	1/8" NPT	05-12260	\$5.35