

# ALT-4

Encoding aviation altimeter with a transponder compatible Serial RS232 & Parallel Gillham code output

Operating Manual – English 1.00



## Introduction

The ALT-4 is a 3 1/8" instrument that contains a precision encoding altimeter and a wide range vertical speed indicator. The altimeter conforms to ANSI standard atmosphere rules from -700 ft up to a maximum of 30 000 ft. The altimeter can display altitude in feet or meters and local pressure can be set in millibars or inches of mercury. The ALT-4 also provides a transponder compatible Serial RS232 and parallel gillham code output.

The onboard VSI indicator is altitude compensated and can be displayed in either feet/minute (ft/min) or meters/second (m/s). It also offers a digital readout with a wide range from +/-20 ft/min to as high as +/-10 000 ft/min, it also offers a logarithmic analog display with a +/-2000 ft range. The VSI can be calibrated by the user once the instrument has been installed in the aircraft.

In addition the ALT-4 provides an OAT sender which is used in determining the density altitude of the aircraft. The ALT-4 can also be used to measure relative altitude and it has a facility for the pilot to enter a reference altitude and deviation band that has to be kept.

## 1 Features

- Precision altimeter from -700 ft up to a maximum of 30 000 ft (-213m to 9144m)
- Provides a transponder compatible Serial RS232 and parallel gillham code output.
- Built in encoder test functions
- The altimeter can display altitude in feet or meters, local pressure can be set in millibars or inches of mercury
- Contains a wide range VSI indicator from +/-20 ft/min to as high as +/-10 000 ft/min
- VSI units can be in feet/minute (ft/min) or in meters/second (m/s)
- Records the maximum and minimum OAT (outside air temperature) and maximum altitude reached in permanent memory
- Records maximum and minimum OAT in temporary memory since instrument power up
- Standard 3 1/8" aircraft enclosure (can be front or rear mounted)
- Rotary control plus 2 independent buttons for easy menu navigation and user input
- Alarm output as well as a red LED illuminates when the alarm has been activated
- Large backlit graphic LCD with adjustable contrast
- Wide input supply voltage range of 8 to 30V DC with built in voltage reversal and over voltage protection for harsh electrical environments
- Light weight design
- Field upgradeable firmware
- 1 year limited warranty

## 2 ALT-4 Layout

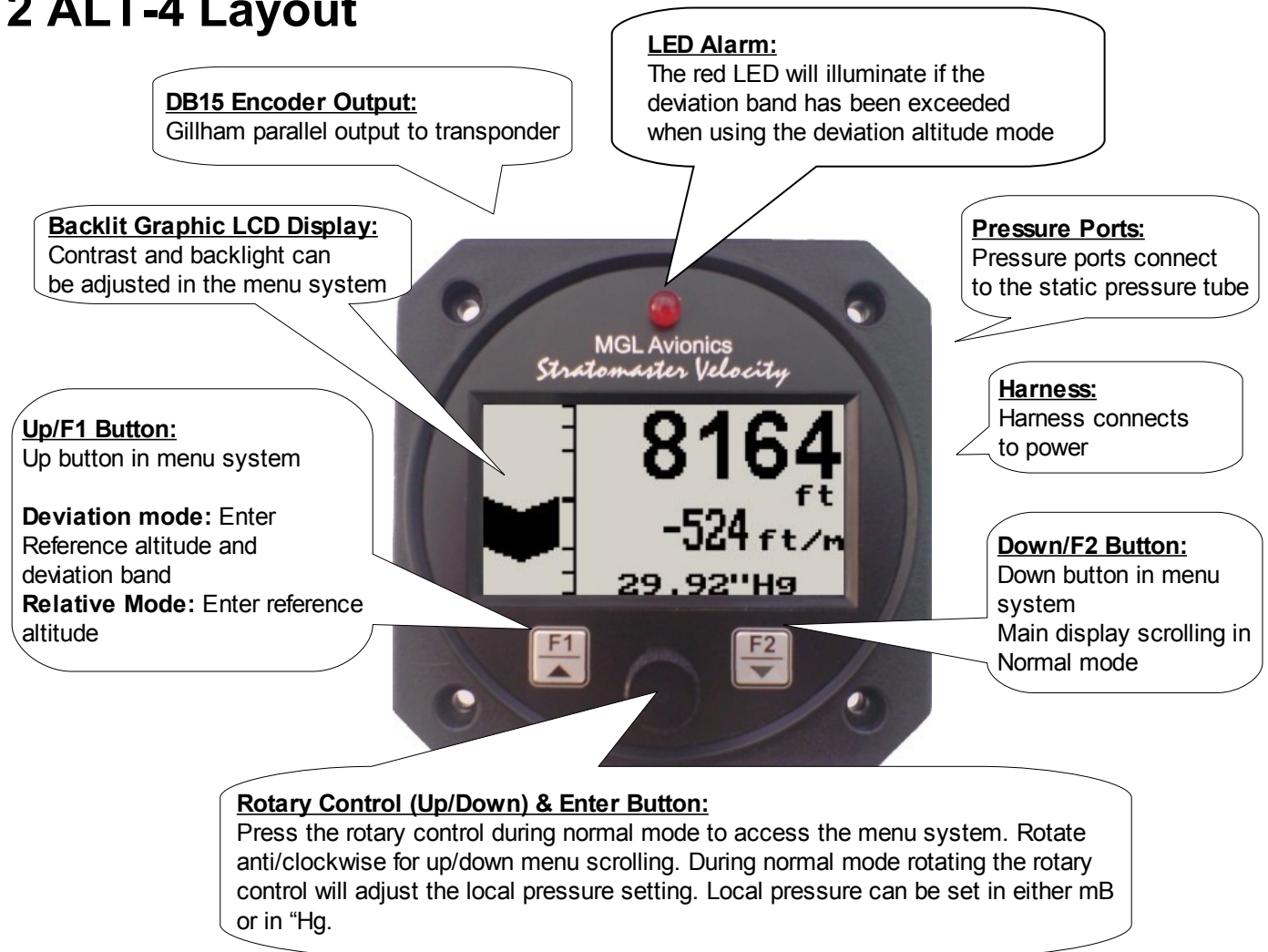

## 3 Main Display

The main displays can be toggled by pressing the F2/Down key.

### 3.1 Altitude and VSI display

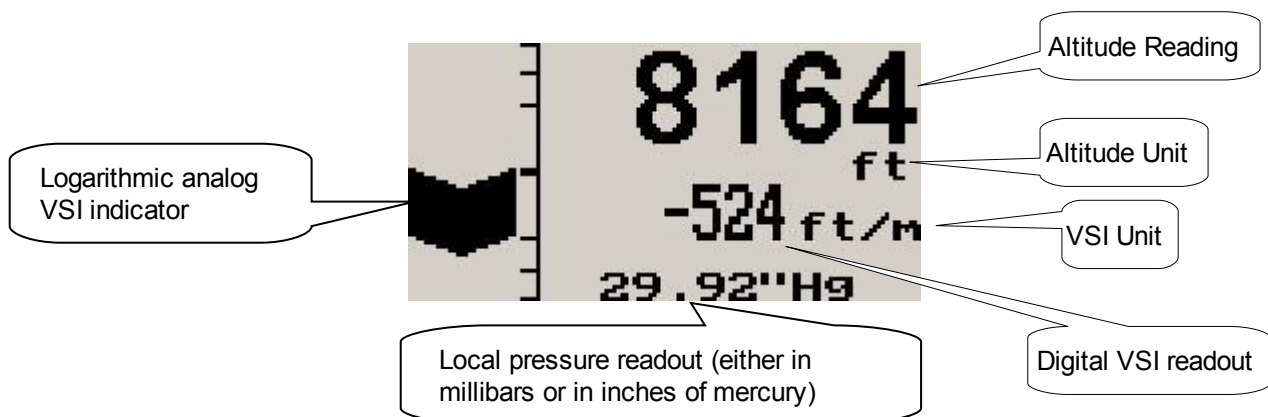

### 3.2 Altitude relative to sea level display

This is the standard display for the ALT-4. Use the rotary control to adjust the local pressure setting.

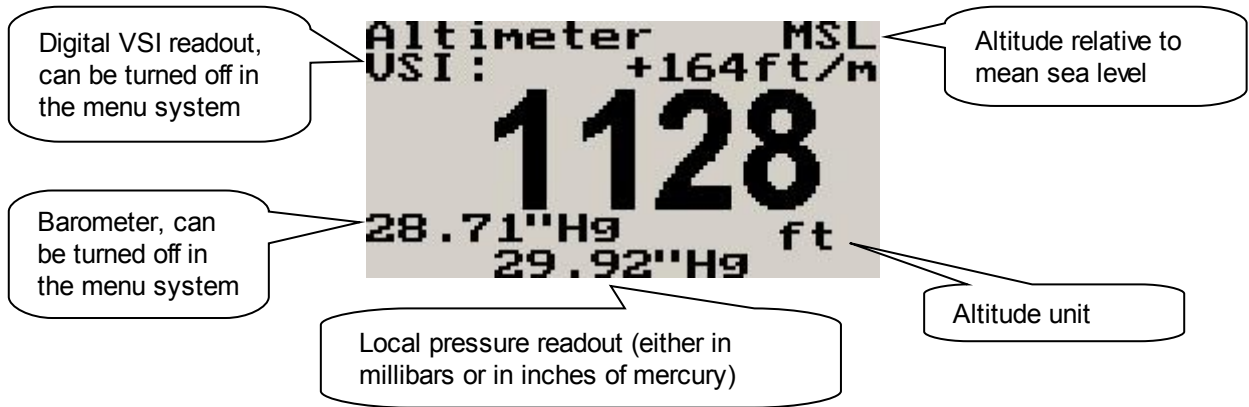

### 3.3 VSI (Vertical Speed Indicator)

The ALT-4 can be setup to be used as a VSI (vertical speed indicator).



### 3.4 Deviation Altitude display

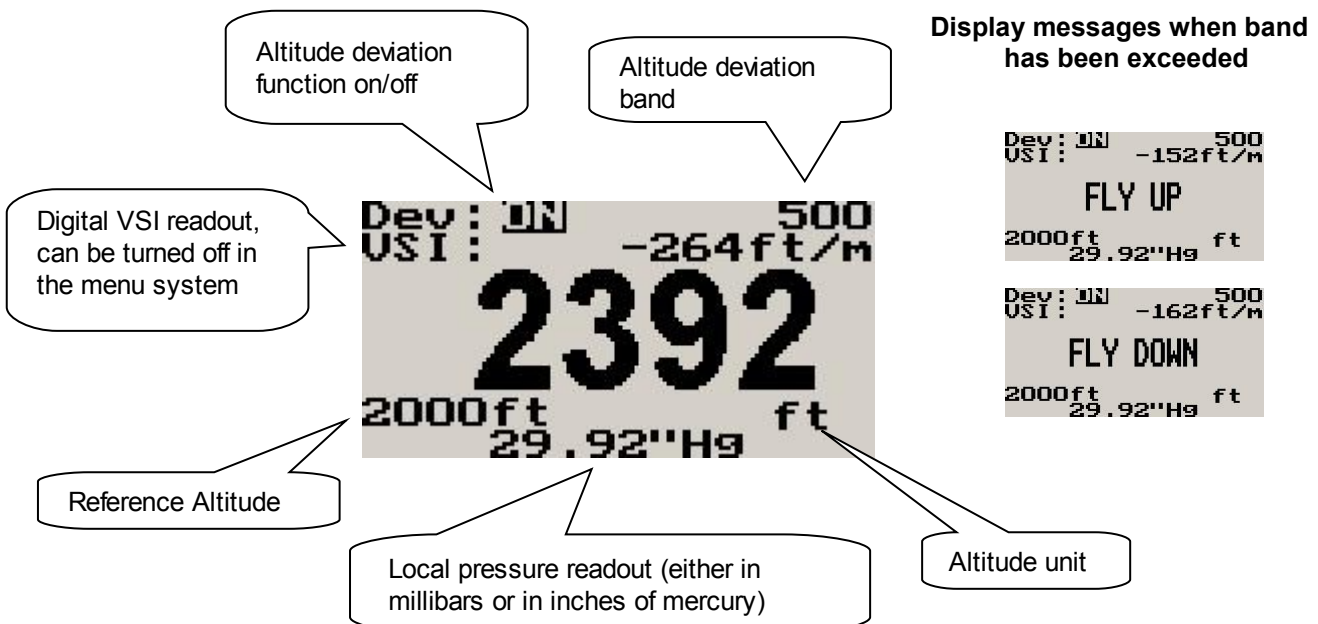

Use the rotary control to adjust the local pressure setting. Pressing the F1/up key will allow the pilot to enter a reference altitude and the deviation band.



Adjust the reference altitude using the rotary control. This is the altitude that the pilot wants to maintain. Press the F1 key to accept, press the F2 key to return to the main display.



Adjust the deviation band above and below your reference altitude that is still acceptable to fly in. Any altitude outside this band will activate the alarm. Press the F1 key to accept, press the F2 button to return to the main display.



Select whether you want the altitude deviation feature enabled or not. Press the F1 key to enable the altitude deviation feature, press the F2 key to disable the altitude deviation feature.

### 3.5 Relative Altitude display

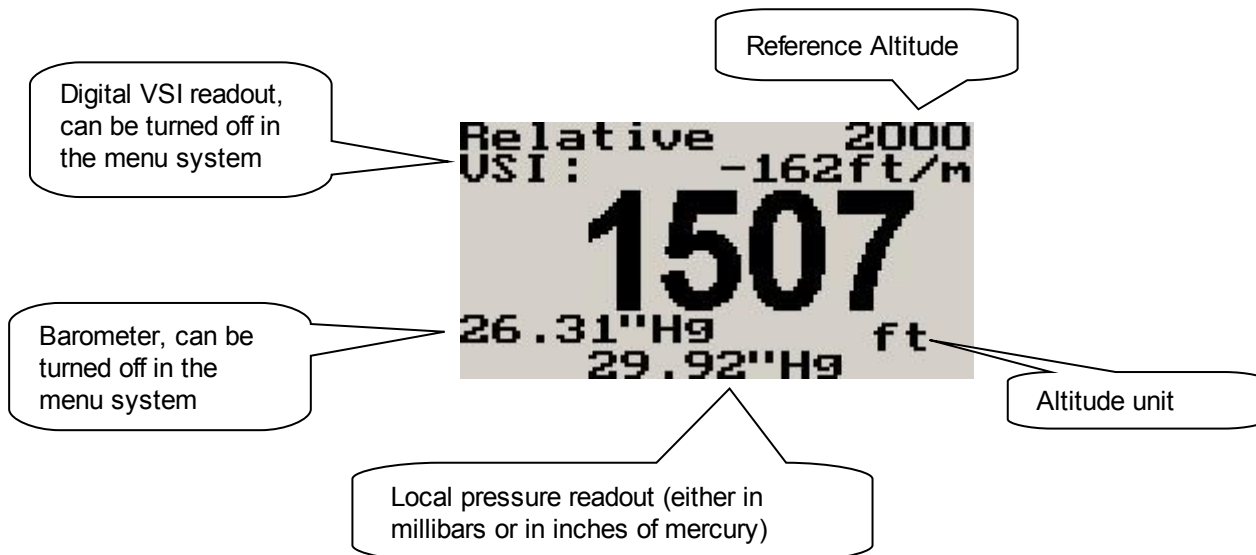

Use the rotary control to adjust the local pressure setting. Pressing the F1/up key will allow the pilot to enter a reference altitude.



Enter the reference altitude you would like to use in relative mode. Use the rotary control to adjust the reference altitude. Press the F1/up key to accept.

### 3.6 Density Altitude display

Density altitude is a perceived altitude that pertains to your current altitude and temperature (and to a lesser extent on your current moisture content of the air). Density altitude is relevant for performance calculations of your aircraft. Density altitude affects the performance of your engine, propeller and airfoils. The most noticeable affects of density altitude are length of take-off and landing runs and the ability of your aircraft to carry weight. There are several methods to calculate density altitude, all result in readings that are very close to each other. We decided to implement a popular formula that is often used by pilots to calculate density altitude at their location.

Da = Density altitude  
 Pa = Pressure altitude  
 T = ambient temperature in degrees C  
 Ts= 15 - 0.0019812 \* pressure altitude (ft)

$$Da = Pa + 118.6 * (T-Ts)$$

The image shows a digital display for density altitude. The text on the display includes: "Density", "USI: -162ft/m", "3856", "2507ft", and "29.92\"Hg ft". Callouts point to various parts: "Digital VSI readout, can be turned off in the menu system" points to "USI: -162ft/m"; "Compensated density altitude value" points to "3856"; "Altitude unit" points to "ft"; "Local pressure readout (either in millibars or in inches of mercury)" points to "29.92\"Hg"; and "Uncompensated altitude value" points to "2507ft".

### 3.7 OAT (Outside air temperature) Display

The OAT probe is used to determine density altitude.

The image shows an OAT display. The text on the display includes: "OAT", "MIN: +6 °C", "MAX: +29 °C", and "+17 °C". Callouts point to: "OAT reading" pointing to "+17 °C"; "Temporary maximum and minimum OAT since instrument power up, reset using the F1/Up key" pointing to "MIN: +6 °C" and "MAX: +29 °C"; and "Temperature unit" pointing to "°C".

## 4 Menu System

Pressing the rotary control button during the normal display mode will cause the ALT-4 to enter the menu system. Use the up/down keys or the rotary control to navigate through the menu system.

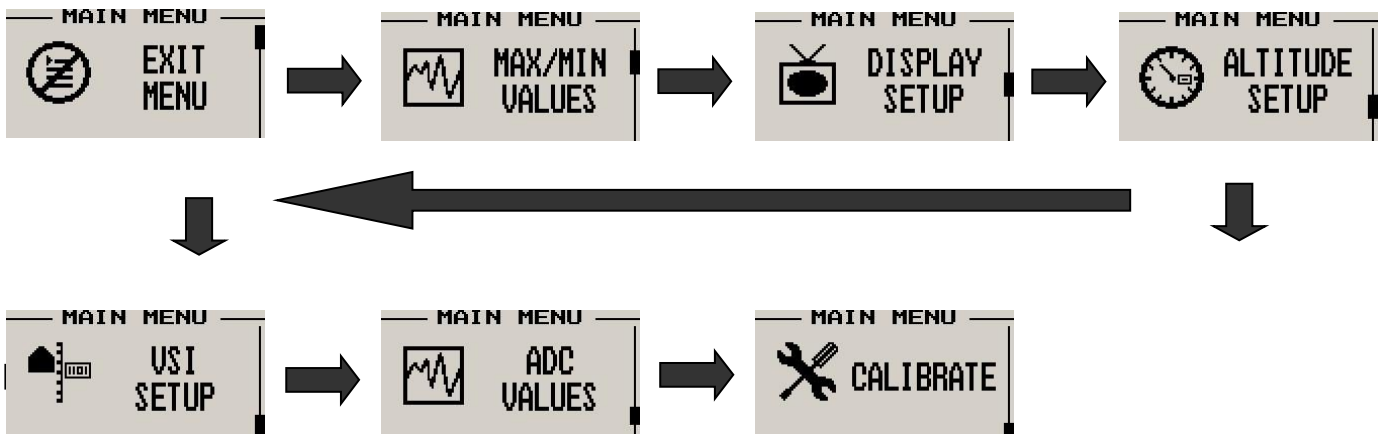

**Note:** (ADC Values and Calibrate Menus are only visible when powering up the unit and pressing the Rotary Control). The text "CALIBRATE" will appear on the intro screen when entering this mode.

**Warning:** The Calibrate Menu is for technical personnel only. Changing any values in this menu may cause the instrument to display incorrect information, and may require the instrument to be returned to the factory for recalibration.

### 4.1 Exit Menu



Press the rotary control on this menu item to exit the menu system. All changes made during navigation of the menu system will be saved in non-volatile memory on exiting the menu system. If you remove power before exiting the menu the instrument will not save any changes.

### 4.2 Maximum Values



To avoid false recordings, the maximum values function is only activated 10 seconds after the instrument has powered up.



Move the highlight over the "DONE" menu item and press the rotary button to return to the main menu.



Move the highlight over this menu item and press the rotary button to reset the maximum altitude and OAT values to the current values.

### 4.3 Display Setup



Move the highlight over this menu option and press the rotary button to return to the main menu.

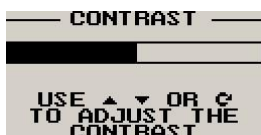

Select this menu option to adjust the display contrast.

```
- DISPLAY SETUP -
*** DONE ***
ADJUST CONTRAST
BACKLIGHT: ON
TEMP UNIT: °C
```

Select this menu option to turn the backlight on or off.

```
- DISPLAY SETUP -
*** DONE ***
ADJUST CONTRAST
BACKLIGHT: ON
TEMP UNIT: °C
```

Select whether you want the OAT to be displayed in degrees Fahrenheit (°F) or in degrees Celcius (°C).

## 4.4 Altitude Setup

```
MAIN MENU
[Clock Icon] ALTITUDE
SETUP
```

All altitude related parameters can be setup here.

```
- ALT SETUP -
*** DONE ***
ALT UNIT: ft
QNH UNIT: mB
BAROMETER: OFF
SP: GARMIN AT
SERIAL RES: 25ft
TEST ENCODER
```

Move the highlight over the “DONE” menu item and press the rotary button to return to the main menu.

```
- ALT SETUP -
*** DONE ***
ALT UNIT: m
QNH UNIT: mB
BAROMETER: OFF
SP: GARMIN AT
SERIAL RES: 25ft
TEST ENCODER
```

Select if you want your altitude readout in feet (ft) or meters (m).

```
- ALT SETUP -
*** DONE ***
ALT UNIT: ft
QNH UNIT: mB
BAROMETER: OFF
SP: GARMIN AT
SERIAL RES: 25ft
TEST ENCODER
```

Select if you want your local pressure readout in millibars (mB) or inches of mercury (“Hg).

```
- ALT SETUP -
*** DONE ***
ALT UNIT: ft
QNH UNIT: mB
BAROMETER: OFF
SP: GARMIN AT
SERIAL RES: 25ft
TEST ENCODER
```

Select if you want the barometer to be displayed on the altitude screens or not.

```
- ALT SETUP -
*** DONE ***
ALT UNIT: ft
QNH UNIT: mB
BAROMETER: OFF
SP: GARMIN AT
SERIAL RES: 25ft
TEST ENCODER
```

Select the protocol of the RS232 output message. The protocol can be selected between GARMIN AT, Magellan, Northstar/Garmin, Trimble/Garmin, MGL Avionics and Microair UAV. Please see section 5 for more information.

```
- ALT SETUP -
*** DONE ***
ALT UNIT: ft
QNH UNIT: mB
BAROMETER: OFF
SP: GARMIN AT
SERIAL RES: 25ft
TEST ENCODER
```

Select the resolution of the output data, a selection of 1,10,25 or 100 ft can be made.

```
- ALT SETUP -
*** DONE ***
ALT UNIT: ft
QNH UNIT: mB
BAROMETER: OFF
SP: GARMIN AT
SERIAL RES: 25ft
TEST ENCODER
```

This is a handy function to test the ALT-4 transponder interface once installation has been completed.

### 4.4.1 Encoder test function

This is a handy function to test the ALT-4 transponder interface once installation has been completed. Both the parallel Gillham and Serial RS232 outputs can be tested. The ALT-4 will resume the normal output of the indicated altitude upon exiting the test function.

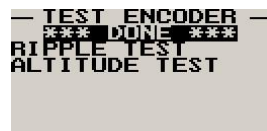
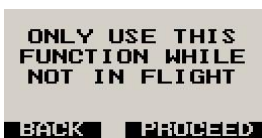

Move the highlight over the “DONE” menu item and press the rotary button to return to the main menu.

**Warning:** Do not use this function while in flight as incorrect altitude information will be sent to the transponder.

### Ripple Test



The ripple test is for the parallel Gillham output only. This test will continuously loop and assert one line at a time starting at the C4 output line and ending in the D4 output line. This test is handy to see if all lines are correctly connected from the ALT-4 to the transponder.

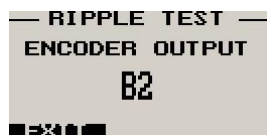

The line that is currently asserted is displayed on the screen. Press the F1/Up key to exit the test.

### Altitude Test

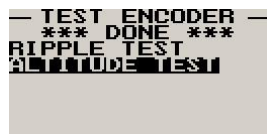

The altitude test can be used to test both the Serial as well as the parallel Gillham output. The altitude test allows the installer to key in a desired altitude and to see if the transponder altitude corresponds.

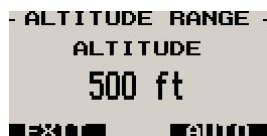

The installer can put the ALT-4 into an auto test mode or a manual test mode. The auto mode will increment the altitude at 100ft per second from -1200 to 30000. In the manual mode the installer can rotate the rotary control to a desired altitude. Press the F1/Up key to exit the test.

### 4.5 VSI (Vertical Speed Indicator) Setup



All VSI related parameters can be setup here.





Move the highlight over the “DONE” menu item and press the rotary button to return to the main menu.



This function is used to set your VSI to read exactly 0ft/min. This is similar to setting the needle on a mechanical VSI to point to zero by turning the adjustment knob on such a VSI. The electronic VSI generally has much less drift compared to a mechanical VSI and this function will only be used very occasionally. Ensure that you perform this function when no pressure changes due to wind or other reasons are occurring.



Select if you want to show the built in VSI (vertical speed indicator). The built in VSI will be shown above the altitude readout.



Select if you want your VSI readout in feet/minute (ft/m) or meters/second (m/s). **Note:** meters/second will be shown with two decimals, example: “1.23”.



This is a function that is used to calibrate your VSI to read exact rates of climb or decent. This function works as a percentage of initial reading. The default setting for this function is 100%. Increasing this value increases the VSI reading and decreasing the value decreases the reading.

**Suggested VSI calibration method**

After you have installed the instrument, perform a calibration flight. This should be done in very calm conditions. Turbulence and thermal activity will make accurate calibration impossible. Many areas have ideal conditions during early mornings or late afternoons. Place the instrument in “feet” unit mode for ease of calibration. Take your aircraft to a few thousand feet above ground and start a glide with a low power setting. Take a stopwatch and when the glide is stable (stable VSI reading) start the stopwatch. Take note of your altimeter reading at the same time. Continue the stable glide for one minute exactly. After the minute has finished, take another reading of your altimeter.

**Example:**

VSI reading during stable glide: -400 ft/min  
 Start altitude: 2500 ft.  
 End altitude: 2050 ft.

In the above example the VSI is under reading by about 12%. Set your VSI calibration to 112% to cancel out the error.

**4.6 ADC Values**



**Note:** This menu item is for technical personnel only, and is not displayed during the normal operation of the instrument. Please see section 4 above on how to access this menu item.



This menu displays the ADC values that have been read from the pressure sensors.

## 4.7 Calibrate



**Note:** This menu item is for technical personnel only, and is not displayed during the normal operation of the instrument. Please see section 4 above on how to access this menu item. Consult your local dealer or factory before entering this menu.



Move the highlight over the “DONE” menu item and press the rotary button to return to the main menu.

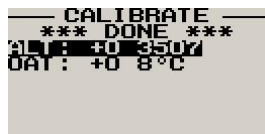

On the back of the ALT-4 you will find the calibration number that has been determined to ensure the most accurate reading of your altimeter. This is the value that should be entered here. Should you have access to an accurate reference you may use this function to calibrate your altimeter. Before you do this, ensure that your calibrated and certified reference is set to the local pressure of 1013mB (29.92”HG). Your altimeter has been calibrated by the factory to an accuracy of +/- one mB or approximately +/- 30 ft (10m).



The ALT-4 is calibrated in degrees Celsius. The ALT-4 is calibrated at the factory using a precision laboratory thermometer. If recalibration is required then adjust the value using the up/down keys or the rotary control until the temperature matches the reference ambient temperature.

## 5 Serial RS232 transponder connection

The ALT-4 outputs a formatted serial RS232 message that can be directly interfaced to various RS232 serial input transponders such as those from Garmin, Trimble, Magellan, Northstar and Microair. The message contains the current pressure altitude with a fixed reference to 1013.25mB (29.92 inches mercury). All protocols use 8 databits, no parity, and 1 stop bit. The message is outputted once a second.

Protocol	Baud Rate	Message format	Example
Garmin AT	1200	#AL, space, +/-, five altitude digits right justified zero padded, T+25, checksum, carriage return  The checksum is a simple modulo 256 sum of the binary values of the individual characters. The checksum is sent as two characters in hexadecimal format	#AL +02372T+25DF[CR]
Magellan	1200	#MGL, +/-, five altitude digits right justified zero padded, T+25, checksum, carriage return  The checksum is a simple modulo 256 sum of the binary values of the individual characters. The checksum is sent as two characters in hexadecimal format	\$MGL+02372T+2513[CR]
Northstar, Garmin	4800	ALT, space, five altitude digits right justified zero padded, carriage return	ALT 02372[CR]
Trimble, Garmin	9600	ALT, space, five altitude digits right justified zero padded, carriage return	ALT 02372[CR]
MGL Avionics	9600	ALT, +/-, five altitude digits right justified zero padded, 1013.25mB (29.92”Hg) referenced, C, +/-, five altitude digits right justified zero padded (corrected to local	ALT+02372C+02372L1013+0000XCA[CR]

		pressure), L, local pressure setting in millibars,+/-, four digit VSI reading right justified zero padded in ft/min, X, checksum, carriage return  The checksum is a simple modulo 256 sum of the binary values of the individual characters. The checksum is sent as two characters in hexadecimal format	
Microair UAV	9600	STX,a,=, five altitude digits right justified zero padded, ETX	[STX]a=02372[ETX]
STX=0x02 ETX=0x03 CR=0x0D			

## 6 Parallel Gillham transponder connection

The ALT-4 has a parallel output Gillham interface that can be directly connected to various parallel input transponders such as those from Garmin, Becker, King, Microair, etc. The output data contains the current pressure altitude with a fixed reference to 1013.25mB (29.92 inches mercury). The following table shows the connection between the ALT-4 and the transponder. See installation section 11 below for more information.

Transponder	A1	A2	A4	B1	B2	B4	C1	C2	C4	Strobe
ARC RT359A/459A/859A	14	13	15	19	17	16	21	18	20	Disable
BECKER ATC 2000/3401	16	15	14	17	19	18	22	21	20	Disable
BECKER ATC 4401	1	2	3	14	15	16	17	18	19	Disable
BENDIX TRP- 2060/2061/660	4	6	8	9	10	11	3	5	7	Disable
BENDIX TR541A/641B	A	B	C	D	E	F	H	J	K	Disable
COLLINS TDR- 950/950L	12	10	7	6	5	4	8	11	9	Disable
EDO-AIRE RT-777	7	5	3	12	13	14	8	6	4	2
GARMIN 320/320A/ 327	3	5	6	9	11	12	10	4	7	Disable
GENAVE BETA 5000	4	5	6	7	8	9	10	11	12	3
KING KT76/78	6	7	9	4	1	2	3	8	10	Disable
KING KT76A/78A/76C/79	M	K	J	E	C	B	D	L	H	Disable
KING 750A	G	H	J	K	L	M	P	R	S	Disable
KING KT75	6	7	8	9	10	11	12	13	14	5
MICROAIR T2000	9	10	11	12	13	17	18	19	20	Disable
NARCO AT50/50A/ 150	7	6	8	12	10	9	14	11	13	5
NARCO AT5/6/6A	2	4	8	9	10	11	1	3	5	12
RADAIR 250	7	6	13	9	10	11	14	16	12	19
TERRA TRT250/250D	5	17	16	15	2	14	3	4	18	12
UPS/APPLLO SL70	13	31	12	33	14	32	16	34	15	Disable
WILCOX 1014A	K	C	W	T	L	D	P	F	Z	Disable

## 7 Loading factory default settings

Pressing and holding the F1 and F2 simultaneously on power up will cause the ALT-4 to load preprogrammed factory default settings. The following screen will be displayed:

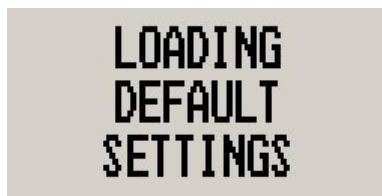

## 8 Operating the alarms

If the alarm is activated, the corresponding item on the display will flash. At the same time the externally available alarm switch will close. The switch will remain closed until any button is pressed to acknowledge the alarm or until the condition(s) that activated the alarm no longer exist. The alarm output can be used to switch an external alarm indicator. The external alarm switch is an open collector transistor switch to ground with a maximum rating of 0.5A DC. It is possible to wire the alarm contacts of several Stratomaster instruments in parallel should this be desired. To avoid false activation of the alarms, the alarm function is only active 10 seconds after the instrument has powered up.

## 9 Cleaning

The unit should not be cleaned with any abrasive substances. The screen is very sensitive to certain cleaning materials and should only be cleaned using a clean, damp cloth.

**Warning:** The ALT-4 is not waterproof, serious damage could occur if the unit is exposed to water and/or spray jets.

## 10 ALT-4 Specifications

<b>Operating Temperature Range</b>	-10°C to 50°C (14°F to 122°F)
<b>Storage Temperature Range</b>	-20°C to 80°C (-4°F to 176°F)
<b>Humidity</b>	<85% non-condensing
<b>Power Supply</b>	8 to 30Vdc SMPS (switch mode power supply) with built in 33V over voltage and reverse voltage protection
<b>Current Consumption</b>	Approx. 45mA @ 13.8V (backlight on) 18mA @13.8V (backlight off)
<b>Display</b>	128x64 graphic LCD display. Contrast and backlight is user configurable, green/yellow backlight
<b>ADC</b>	12bit over sampled successive approximation
<b>Dimensions</b>	see Velocity series dimensional drawing
<b>Enclosure</b>	3 1/8" ABS, black in color, front or rear mounting
<b>Weight</b>	Approx. 198 grams
<b>Alarm contact current rating</b>	Open collector transistor switch to ground. Maximum rating 0.5A DC
<b>Non-volatile memory storage</b>	100000 write cycles
<b>Altimeter range</b>	-700ft to 30 000ft (-213m to 9144m)
<b>Altimeter resolution</b>	1ft/1m
<b>Altitude measurement accuracy</b>	+/- 1mB, +/- 30ft at sea level
<b>Digital VSI range</b>	+/-20ft/m to +/-10 000ft/m

Digital VSI resolution	10ft
Analog VSI range	+/-2000 ft/m, logarithmic scale
VSI measurement accuracy	+/- 2%, relative to calibration
Gillham code port	DB15 connector, Open collector darlington drivers
Serial port	RS232 voltage levels, transmit only

## 11 Installation

Connect the static port to a suitable static air pressure line. If you have a slow aircraft or an aircraft where the internal cabin pressure does not change during flight and is equivalent to the outside air pressure you may find that it is not required to connect a static port.

For installations in typical ultralight aircraft pods, be aware of possible pressure changes inside the pod during flight caused by ram air or suction effects. This may lead to a false indication of altitude. Often these effects are dependent on the current angle of attack of the airflow around your pod. You will need to install a suitable static port in these cases.

The use of an external 1A fuse is recommended. Connect the supply terminals to your aircraft's power supply. The ALT-4 can be used on both 12V and 24V without the use of any pre-regulators. Ensure that the supply voltage will not drop below 8V during operation as this may result in incorrect readings.

### 11.1 Gillham Encoder transponder interface

The ALT-4 altimeter will measure altitudes typically to around 42 000 ft, however, this requires a transponder that uses signal D4. Transponders that do not have D4 can only transmit altitudes up to 35000 ft. If your transponder only accepts codes A1 to C4 then you leave signal D4 unconnected. The ALT-4 produces inverted Gillman codes as required by virtually all transponders. The outputs are open collector types and will sink currents up to a few mA.

It is recommended to use shielded cable for the connection between the ALT-4 and the transponder if a long cable needs to be used. The shield should be connected to ground at one point only (either on the encoding altimeter side or on the transponder side).

Installation of the wiring requires solder work. This needs to be done using electronic resin flux solder wire and proper temperature controlled soldering stations. Do not attempt this if you are unfamiliar with electronic soldering techniques. Please get professional assistance to do this. Bad connections can result in your transponder broadcasting incorrect altitude codes.

See parallel transponder connection section 6 above for various transponder interface connections.

#### Attention:

Your country may have regulations that do not allow you to install a transponder or an encoding altimeter yourself. The installation may have to be performed by an authorized person or company. Please check your applicable regulations with your aviation authorities.

### Important information:

Depending on laws and regulations in your country you may not be allowed to install a transponder and associated equipment yourself. This work may have to be done by a certified AMO or instrument technician.

Please check with your relevant authorities.

The ALT-4 encoding altimeter is uncertified equipment and may normally only be used in uncertified aircraft, homebuilt aircraft and microlights (ultralights). Special operations permits for other aircraft may be required. Please be very aware that any wiring mistake related to the application of Gillham codes to your transponder will result in incorrect altitudes broadcast by your transponder. Any installation involving the ALT-4 must be checked by a suitably equipped aircraft instrument maintenance outfit before operation. Failure to do this may be a criminal offence in your country.

### 11.2 Connection Diagram

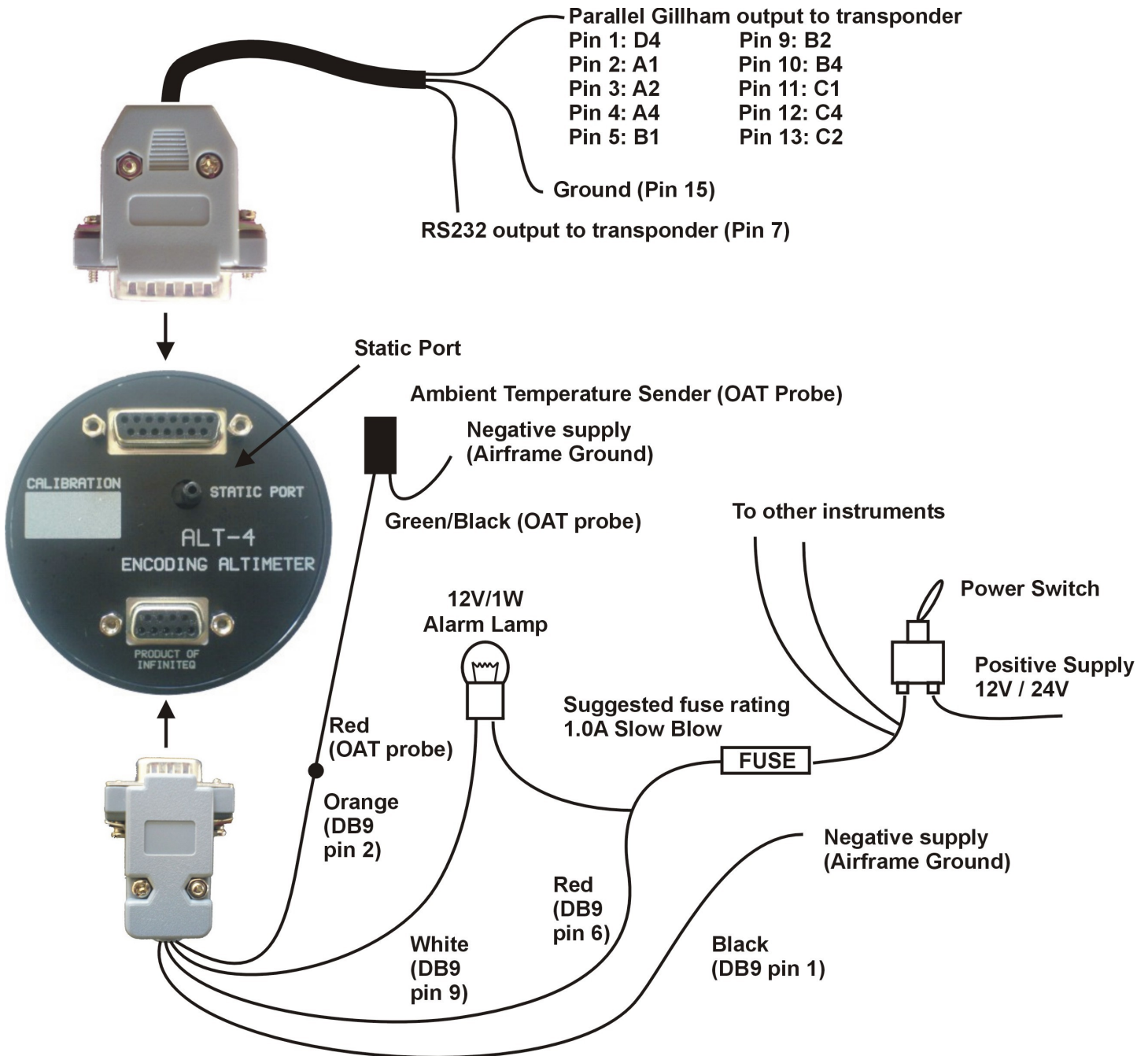

### 11.3 ALT-4 DB9 Cable connections

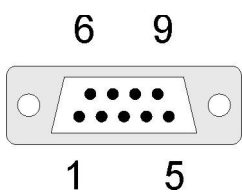

DB 9 Pin	Color	Function
1	Black	Ground
2	Orange	OAT Sensor
4	NC	Airtalk communication (Not connected). Used for firmware upgrading
6	Red	8-30Vdc power
9	White	Alarm Output

### 11.4 ALT-4 DB15 Cable connections

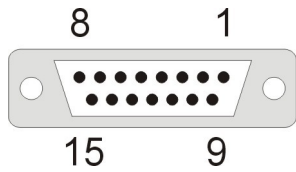

DB 15 Pin	Function
1	Gillham Output D4
2	Gillham Output A1
3	Gillham Output A2
4	Gillham Output A4
5	Gillham Output B1
7	RS232 Transmit output
9	Gillham Output B2
10	Gillham Output B4
11	Gillham Output C1
12	Gillham Output C4
13	Gillham Output C2
15	Ground

### 11.5 Pressure Port Dimensions

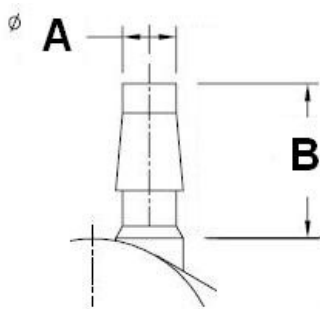

	Inches		Millimeters	
	Min	Max	Min	Max
<b>A</b>	0.182	0.194	4.62	4.93
<b>B</b>	0.420	0.440	10.67	11.18

## 12 Warranty

This product carries a warranty for a period of one year from date of purchase against faulty workmanship or defective materials, provided there is no evidence that the unit has been mishandled or misused. Warranty is limited to the replacement of faulty components and includes the cost of labor. Shipping costs are for the account of the purchaser.

**Damage as a result of applying excessive pressure to the pressure ports are excluded from warranty.**

**Note:** Product warranty excludes damages caused by unprotected, unsuitable or incorrectly wired electrical supplies and or sensors, and damage caused by inductive loads.

## 13 Disclaimer

Operation of this instrument is the sole responsibility of the purchaser of the unit. The user must make themselves familiar with the operation of this instrument and the effect of any possible failure or malfunction.

This instrument is not certified by the FAA. Fitting of this instrument to certified aircraft is subject to the rules and conditions pertaining to such in your country. Please check with your local aviation authorities if in doubt. This instrument is intended for ultralight, microlight, homebuilt and experimental aircraft. Operation of this instrument is the sole responsibility of the pilot in command (PIC) of the aircraft. This person must be proficient and carry a valid and relevant pilot's license. This person has to make themselves familiar with the operation of this instrument and the effect of any possible failure or malfunction. Under no circumstances does the manufacturer condone usage of this instrument for IFR flights.

The manufacturer reserves the right to alter any specification without notice.

## Other instruments in the *Stratomaster Velocity* series

<b>ALT-3</b>	Encoding aviation altimeter and Vertical speed indicator (VSI)
<b>ALT-4</b>	Encoding aviation altimeter with Serial RS232 & Parallel Gillham code output
<b>ASI-3</b>	Airspeed indicator (ASI) with automatic flight log
<b>ASX-2</b>	Encoding aviation altimeter and Airspeed indicator (ASI)
<b>AV-2</b>	Artificial horizon and magnetic compass indicator
<b>E-1</b>	Universal engine monitor
<b>FLIGHT-2</b>	Primary Flight instrument
<b>FF-3</b>	Fuel Computer (single or dual fuel tanks)
<b>GF-2</b>	+/-10G tilt compensated dual range G-force meter
<b>MAP-2</b>	Manifold pressure and RPM Indicator
<b>ROTOR-1</b>	Dual Rotor / Engine tachometer
<b>RTC-1</b>	Aviation real time clock (RTC), outside air temperature (OAT) and Voltage display
<b>RV-3</b>	Universal engine / Rotor RPM Indicator
<b>TC-2</b>	4-Channel thermocouple (EGT/CHT) indicator
<b>TC-3</b>	12-Channel thermocouple (EGT/CHT) indicator
<b>TP-2</b>	Universal temperature and pressure gauge