



9800 Martel Road
Lenoir City, TN 37772

www.ps-engineering.com

PDA360EX



Document P/N 200-360-0000

December 2014

Audio Selector Panel for Experimental Aircraft
High-fidelity Stereo Intercom, USB Charging Port
System Installation and Operation Manual
Patented under one or more of the following;
No. 4,941,187; 5,903,227; 6,160,496 and 6,493,450, 7,391,877

**Warranty is not valid unless this product is installed by an
Authorized PS Engineering dealer or factory harness is purchased.**

PS Engineering, Inc. 2014 ©
Copyright Notice

Any reproduction or retransmittal of this publication, or any portion thereof, without the expressed written permission of PS Engineering, Inc. is strictly prohibited. For further information contact the Publications Manager at PS Engineering, Inc., 9800 Martel Road, Lenoir City, TN 37772. Phone (865) 988-9800, email contact@ps-engineering.com.

Table of Contents

Section I – GENERAL INFORMATION.....	1-1
1.1 INTRODUCTION.....	1-1
1.2 SCOPE	1-1
1.3 EQUIPMENT DESCRIPTION.....	1-1
1.4 APPROVAL BASIS *NONE*	1-1
1.5 SPECIFICATIONS.....	1-2
1.6 EQUIPMENT SUPPLIED.....	1-2
1.7 EQUIPMENT REQUIRED BUT NOT SUPPLIED	1-3
1.8 LICENSE REQUIREMENTS.....	1-3
Section II - INSTALLATION	2-1
2.1 GENERAL INFORMATION.....	2-1
2.1.1 SCOPE.....	2-1
2.2 UNPACKING AND PRELIMINARY INSPECTION	2-1
2.3 EQUIPMENT INSTALLATION PROCEDURES.....	2-1
2.3.1 COOLING REQUIREMENTS	2-1
2.3.2 MOUNTING REQUIREMENTS	2-1
2.3.3 AUDIO PANEL MOUNTING RACK INSTALLATION.....	2-1
2.3.4 AUDIO PANEL TRAY AND CONNECTOR ASSEMBLY	2-1
2.4 CABLE HARNESS WIRING	2-2
2.4.1 ELECTRICAL NOISE.....	2-2
2.4.2 EXISTING GMA340 AND PMA8000 INSTALLATIONS	2-3
2.4.3 POWER	2-3
2.4.4 COMMUNICATIONS PUSH-TO-TALK.....	2-3
2.4.5 AUDIO PANEL INTERFACE	2-4
2.4.6 TRANSMIT INTERLOCK	2-4
2.4.7 BACKLIGHTING.....	2-4
2.4.8 UNSWITCHED INPUTS.....	2-4
2.4.9 "SWAP" MODE	2-5
2.5 INTERCOM WIRING	2-5
2.5.1 MUSIC INPUTS.....	2-5
2.5.2 PLAYBACK BUTTON INSTALLATION	2-6
2.6 USER ADJUSTMENTS	2-6
2.6.1 ADJUST SCREEN.....	2-6
2.6.2 RENAME "SWITCHED" INPUTS.....	2-7
2.6.3 BLUETOOTH® MENU	2-7
2.7 COMMUNICATIONS ANTENNA INSTALLATION NOTES	2-8
2.8 PDA360EX PIN ASSIGNMENTS	2-9
2.9 WIRING CHECKOUT	2-10
2.10 UNIT INSTALLATION.....	2-10
2.11 OPERATIONAL CHECKOUT	2-10
2.11.1 AUDIO PANEL TEST	2-10
2.11.2 BLUETOOTH CHECKOUT	2-10
2.11.3 INTERNAL RECORDER CHECKOUT.....	2-11
2.12 FINAL INSPECTION	2-11
Section III OPERATION.....	3-1
3.1 SCOPE	3-1
3.2 POWER AND FAIL SAFE (1).....	3-1
3.3 MENU SELECTION (6).....	3-1
3.4 COMMUNICATIONS TRANSMIT (XMT) SELECTION (2).....	3-2
3.4.1 SPLIT MODE.....	3-2
3.5 COM AUDIO SELECTOR (3).....	3-2
3.5.1 SWAP MODE (SWITCH FROM COM 1 TO COM 2 REMOTELY)	3-2

PS Engineering
PDA360EX Audio Selector Panel and Intercom System
Installation and Operator's Manual

3.5.2 INTELLIAUDIO® DIMENSIONAL AUDIO 3-3

3.5.3 COM MONITOR MODE 3-3

3.5.4 NAVAID SELECTION (4) 3-3

3.6 INTERCOM OPERATION (8) 3-4

3.6.1 *INTELLIVOX*® INTERCOM VOX-SQUELCH 3-4

3.6.2 INTERCOM VOLUME CONTROL (1) 3-5

3.6.3 INTERCOM MODES (8) 3-5

3.7 MUSIC AND MUSIC MUTING 3-5

3.7.1 MUSIC MUTING 3-6

3.7.2 MUSIC VOLUME..... 3-7

3.7.3 MUSIC IN PILOT ISO MODE..... 3-7

3.8 BLUETOOTH® CONNECTION..... 3-7

3.8.1 PAIRING AND UNPAIRING BLUETOOTH DEVICES 3-8

3.9 BLUETOOTH® TELEPHONE MODE 3-8

3.9.1 CELLULAR TELEPHONE SIDETONE 3-8

3.10 INTERNAL RECORDER AND PLAYBACK..... 3-9

3.11 USER SETUP MENUS..... 3-9

3.12 LCD ADJUSTMENT..... 3-10

3.12.1 DISPLAY TIMEOUT..... 3-10

3.12.2 RENAME “SWITCHED” INPUTS..... 3-11

3.12.3 BLUETOOTH SETUP..... 3-11

3.13 USB CHARGING PORT (10)..... 3-12

Section IV – Warranty and Service..... 4-1

4.1 WARRANTY..... 4-1

4.2 FACTORY SERVICE 4-1

Appendix A – PDA360EX Installation Drawings A

Appendix B – J1 Connector InterconnectB

Appendix C – J2 Connector Interconnect C

Rev	Date	Change
0	December 2014	New Release
1		
3		

Section I – GENERAL INFORMATION

1.1 INTRODUCTION

The PDA360EX represents a revolutionary step in cockpit audio control and intercommunications utility. IntelliAudio®, using the USAF patented technology, provides True Dimensional Sound, helping pilots to more easily discern from simultaneous radio receptions. Our patented *IntelliVox*® design, front panel USB power jack, and pilot programmable configurations, marks this panel as the next level of audio control. The unit is designed for outstanding ergonomics and visually defined mode annunciation and selection.

Before installing and/or using this product, please read this manual completely. This will ensure that you will take full advantage of all the advanced features in the PDA360EX.

1.2 SCOPE

This manual provides detailed installation and operation instructions for the PS Engineering PDA360EX-series of Audio Selector Panel/Intercom Systems. This includes the following units:

Model	Description	Part Number
PDA360EX	Digital Stereo Audio Selector Panel USB Charging port	050-360-0200

1.3 EQUIPMENT DESCRIPTION

The PDA360EX is a state-of-the-art audio isolation amplifier and audio selector that contains an automatic voice activated (VOX) intercom system and DC power supply for personal electronic devices. It can switch two transceivers (Com 1, Com 2) and six receivers (Nav 1, Nav 2, and three additional inputs which can be individually labeled, for use with ADF, DME, AUX, etc.).

Warning: Use of non-aviation approved cellular telephone equipment may be prohibited by FCC regulation. PS Engineering is not responsible for unauthorized airborne use of cellular telephones. For airborne use, the PDA360EX must be interfaced with an approved system.

There are four unswitched inputs, available for traffic or EGPWS, autopilot disconnect, and/or radar altimeter warning.

Pushbuttons select the receiver audio source provided to the headphones. Pushbutton switches select one of the communication transceivers for the pilot and copilot position, and allows radio transmission. In "Split Mode" the PDA360EX has the ability to allow the pilot to transmit on Com 1 while the copilot can transmit on Com 2. A fail-safe mode connects the pilot headphone and microphone to COM 1 if power is removed for any reason, or if the power switch is placed in the Off (Fail-safe) position. Unswitched input #1 is also provided to the pilot headphone (left side headset ear cup) in fail-safe

A four-station voice activated (VOX) intercom is included in the PDA360EX. This system has PS Engineering's patented *IntelliVox*® circuitry that eliminates manual adjustments. The intercom system incorporates pilot isolate, all and crew modes, two independent stereo music inputs with "SoftMute™". Intercom volume control is through two concentric front panel knobs and a pushbutton intercom mode switch. The small volume knob controls the intercom level for the pilot and copilot, while the large knob controls the passenger intercom volume. Intercom squelch is automatic.

The front panel USB-type connector is available for charging devices, such as iPad or cell phones. Up to 10 Watts are available. This connector *does NOT* provide any data interface.

In the PDA360EX, a Bluetooth® wireless interface is available for wireless telephone and music connection.

1.4 APPROVAL BASIS *NONE*

The PDA360EX is intended for experimental-amateur built aircraft only.

This article is not intended for installation in aircraft with Standard Airworthiness Certificate.

1.5 SPECIFICATIONS

TSO COMPLIANCE	
DIMENSIONS:	Height: 1.3 in. (3.3 cm) Width: 6.25 in. (16.9 cm) Depth behind panel 7.15 in. (18.16 cm)
WEIGHT <i>PDA360EX Unit</i> <i>Rack with connectors</i>	1.34 lb. (0.61 kg) 0.51 lb. (0.24 kg)
POWER REQUIREMENTS (Including Internal Lighting):	
<i>Voltage:</i>	11 to 33 VDC
<i>Maximum Current:</i>	3.5 Amp (Externally protected by a 5A pull-type breaker)

Audio Selector Specifications	
<i>Audio selector panel input impedance:</i>	510 Ω
<i>Input Isolation:</i>	-60 dB (min.)
<i>Receiver Inputs:</i>	7 (Com 1, Com 2, Nav 1, Nav 2, 3 ea. Switched Inputs available)
<i>Unswitched Inputs:</i>	4
<i>Transmitter Selections:</i>	3 (Com 1, Com 2, Com1/2 split)
<i>Headphone Impedance:</i>	150 – 1000 Ω
<i>Headphone Output:</i>	30 mW each headset, no clipping <.5% THD typical
<i>Microphone Impedance:</i>	150 - 600 Ω
Bluetooth Radio	Class 3, FCC ID QOQWT32AE
Intercom Specifications	
<i>Intercom Positions:</i>	4 places (with individual <i>IntelliVox</i> ® circuits)
<i>Music Inputs:</i>	2, (Independent, Stereo)
<i>Music Muting:</i>	>-30 dB "Soft Mute" when Com or intercom active.
<i>Distortion:</i>	<1% THD @ 30 mW into 150Ω
<i>Mic Freq. Response, 3 dB:</i>	300 Hz - 6000 Hz
<i>Music Freq. Response, 3 dB:</i>	10 Hz – 26 kHz

1.6 EQUIPMENT SUPPLIED

1 ea. of the following units:

Model	Description	Part Number
PDA360EX	PDA360EX Digital Audio Panel with Stereo Intercom, USB Charging jack, and Bluetooth connectivity	050-360-0200

PS Engineering
PDA360EX Audio Selector Panel and Intercom System
Installation and Operator's Manual

PDA360EX Installation Kit: 250-890-0000

Description	Quantity	Part Number
Installation rack assembly	1	430-890-0040
Rack back plate	1	430-890-0050
44-pin connector kit	2	120-891-2045
Backshell, connector	2	625-025-2465
Backshell Retainer	2	431-881-0100
4 40 X 7/16 screw w/nylon patch	4	475-440-0007
4 40 X 3/8 screw w/nylon patch	4	475-440-1038
4-40 x 1/4" screw with lock washer	2	475-440-0001
Solder Lug	2	475-009-0001
Cable Clamp	1	625-001-0002
#6-32 x 1/2" Flat head Philips screw	6	475-632-0012
#6-32 Clip Nut	6	475-630-0002

1.7 EQUIPMENT REQUIRED BUT NOT SUPPLIED

- a. Circuit Breaker: 1 ea; 5 amp PULL TYPE REQUIRED for PDA360EX
- b. Headphone Jacks (Stereo, as Required)
- c. Microphone Jacks (as Required)
- d. Headphones, 150 Ω (Stereo), up to 6 as required
- e. Microphones, up to 6 as required
- f. Interconnect Wiring

1.8 LICENSE REQUIREMENTS

None

PDA360EX Bluetooth™ Radio approval:

- FCC ID: QQQWT32AE
- Industry Canada ID: 5123A-BGTWT32AE
- CE EMC Directive 89/336/EEC as amended by Directives 92/31/EEC and 93/68/EEC

Section II - INSTALLATION

2.1 GENERAL INFORMATION

2.1.1 SCOPE

This section provides detailed installation and interconnection instructions for the PS Engineering PDA360EX Audio Selector Panel/Intercom.

Please read this manual carefully before beginning any installation to prevent damage and post-installation problems.

2.2 *Unpacking and Preliminary Inspection*

Use care when unpacking the equipment. Inspect the units and parts supplied for visible signs of shipping damage. Examine the unit for loose or broken buttons, bent knobs, etc. Verify the correct quantity of components supplied with the list in §1.6. If any claim is to be made, save the shipping material and contact the freight carrier. Do NOT return units damaged in shipping to PS Engineering. If the unit or accessories show any sign of external shipping damage, contact PS Engineering to arrange for a replacement. Under no circumstances attempt to install a damaged unit in an aircraft. Equipment returned to PS Engineering for any other reason should be shipped in the original PS Engineering packaging, or other UPS approved packaging.

2.3 *Equipment Installation Procedures*

2.3.1 Cooling Requirements

Forced air-cooling of the PDA360EX is not required. However, the units should be kept away from heat producing sources (i.e. defrost or heater ducts, dropping resistors, heat producing avionics) without adequate cooling air provided.

2.3.2 Mounting Requirements

The PDA360EX must be rigidly mounted to the instrument panel of the aircraft structure, within view and reach of the pilot position(s). Installation must comply with FAA Advisory Circular AC 43.13-2B, or other FAA-approved aircraft technical data. The unit may be mounted in any area where adequate clearance for the unit and associated wiring bundle exist.

To prevent noise, avoid installing the unit close to high current devices or systems with high-voltage pulse type outputs, such as DME or transponders. Avoid running the interconnecting bundles near any high current wires.

2.3.3 Audio Panel Mounting Rack Installation

Remove the unit from the mounting tray by unscrewing the 3/32" hex-head screw that is in the center of the unit. Use caution to avoid hitting the photo-detector lens. Carefully slide the unit free of the tray. Set the unit aside in a safe location until needed. Install the tray using six clip nuts (475-630-0002), and six FHP 6-32 x 1/2" screws (475-632-0012). The audio selector panel must be supported at front and rear of the mounting tray.

2.3.4 Audio Panel Tray and Connector Assembly

The rack connectors mate with two 44-pin connectors in the PDA360EX. The connectors are a sub-miniature crimp-type, and require the use a hand crimp tool, from table below (or equiv.). The connectors are mounted to the tray back plate with #4-40 screws (475-440-1038), from the inside of the tray and the mounting block, 431-891-0100. Ensure that proper strain relief and chafing precautions are made during wiring and installation, using the cable clamp (625-001-0002).

Two grounding lugs are provided, which may be attached to the rear mounting plate with 2 ea #4-40 x 1/4" screws with captivated lock washers. These provide a convenient location to connect the shield ground terminations.

Manufacturer	Crimping Tool	Positioner	Extraction tool
AMP	601966-1	601966-6	91067-1
Daniels	AFM8	K42	M24308-1
ITT-Cannon	995-0001-584	995-0001-739	91067-1

Table 2-1 Connector Pin crimping tools

2.4 Cable Harness Wiring

Referring to the appropriate Appendix, assemble a wiring harness as required for the installation. All wires must be MIL-SPEC in accordance with current regulations. Two- and three-conductor shielded wire must be used where indicated, and be MIL-C-27500 or equivalent specification. Proper stripping, shielding and soldering technique must be used at all times. It is imperative that correct wire be used.

Refer to FAA Advisory Circular 43.13-2B for more information. Failure to use correct techniques may result in improper operation, electrical noise or unit failure. Damage caused by improper installation will void the PS Engineering warranty.

PS Engineering can custom build a wiring harness, contact us at 865-988-9800 for more information.

2.4.1 Electrical Noise

Due to the variety and the high power of radio equipment often found in today's general aviation aircraft, there is a potential for both radiated and conducted noise interference.

The PDA360EX power supply is specifically designed to reduce conducted electrical noise on the aircraft power bus by at least 50dB. Although this is a large amount of attenuation, it may not eliminate all noise, particularly if the amplitude of noise is very high. There must be at least 13.8 VDC present at the connector, J2 pins 8 & 9, of the PDA360EX for the power supply to work in its designed regulation. Otherwise, it cannot adequately attenuate power line noise. Shielding can reduce or prevent radiated noise (i.e., beacon, electric gyros, switching power supplies, etc.) However, installation combinations can occur where interference is possible. The PDA360EX was designed in a RFI hardened chassis and has internal Electromagnetic Interference (EMI) filters on all inputs and outputs.

Ground loop noise occurs when there are two or more ground paths for the same signal (i.e., airframe and ground return wire). Large cyclic loads such as strobes, inverters, etc., can inject noise signals onto the airframe that are detected by the audio system. Follow the wiring diagram very carefully to help ensure a minimum of ground loop potential. Use only Mil Spec shielded wires (MIL-C-275000, or better). Under no circumstances combine a microphone and headphone wiring into the same shielded bundle. Always use a 2- or 3-conductor, shield wire as shown on the installation-wiring diagram.

The shields can be daisy-chained together, and then connected to the ground lugs mounted on the back plate shown in Appendix B.

Radiated signals can be a factor when low level microphone signals are "bundled" with current carrying power wires. Keep these cables physically separated. It is very important that you use insulated washers to isolate the ground return path from the airframe to **all** headphone and microphone jacks.

2.4.1.1 Music Inputs and Noise

PDA360EX units utilize a differential input to help prevent noise from entering the music system. This feature is usually transparent to the installer; however, it is important that the appropriate music signal and ground connections are made directly to the dedicated music signal and ground inputs on the PDA360EX. The power for IFE and audio panel should be a common bus.

If a music jack instead of a music source is installed for Music 1 or 2, we recommend grounding the jack to airframe ground.

NOISE NOTE

Adding a high-performance audio control system, particularly in conjunction with high-performance active noise canceling headsets, cannot improve on older avionics that were designed for cabin-speaker use. PS Engineering makes no claim that the audio panel will provide a noise-free audio quality under all installation conditions, particularly with older avionics.

2.4.2 Existing GMA340 and PMA8000 Installations

If the installation replaces a GMA340 or any of the PMA8000 series, no changes are necessary as long as the existing installation meets the requirements. All existing functions of the GMA340 as afforded by the PDA360EX will become instantly available. However, if the previous installation had three COMs, the PDA360EX will not support the third COM, the PDA360EX handles only two COM transceivers. The PMA8000C will support three coms.

2.4.2.1 Differences with GMA340 connector

Connector	Pin	GMA340 Function	PDA360EX Function
J1	3	COM 3	No Connection
J1	4	COM 3	No Connection
J1	5	COM 3	No Connection
J1	6	COM 3	No Connection
J1	16	MASQ Inhibit	No Connection
J1	23	COM 3 Speaker Load	AUX Audio Input
J1	24	COM 3 Speaker Load	CNX80 Inhibit
J1	25	COM Speaker Load	No Connection
J1	26	COM Speaker Load	No Connection
J1	27	COM Speaker Load	No Connection
J1	28	COM Speaker Load	No Connection
J1	29	No Connection	Unswitched #3
J2	15	High Music Gain Select	Unswitched #4
J2	17	8 Speaker Select	No Connection
J2	18	No Connection	Aux Enable Output
J2	19	Tone Enable	No Connection
J2	29	Failsafe warn	No Connection

Table 2-2 GMA340–PDA360EX connector differences

2.4.3 Power

The PDA360EX is compatible with both 14 and 28 Volt DC systems. A five (5) Amp circuit breaker is required for all installations. Power and ground wires should be #22 connected to J2 Pins 8 and 9. Connect airframe ground to J2 Pin 10 and 11 only. No dropping resistors are required.

2.4.4 Communications Push-to-Talk

An important part of the installation is the PTT (Push-To-Talk) switches that allow the use of your aircraft communications radio for transmissions. There are three typical configurations that can be used. Select the case that best fits the installation. Only the person who presses their PTT switch will be heard over the radio. If the pilot and copilot both use the PTT, the only pilot position has access to the radio. The pilot position will have PTT control regardless of the mic selector switch or copilot PTT when the PDA360EX is in the OFF/EMG mode.

CASE I: PTT is built into both pilot and copilot yokes.

CASE II: PTT is in pilot yoke only. This configuration requires a modified external PTT switch plugged into the copilot's microphone jack. (See Appendix A). When the copilot's PTT is pressed, the intercom switches the microphone audio from pilot to copilot mic.

CASE III: No built in PTT. This requires two built in PTTs to be installed, or modified external PTT switches to be used. Modify external PTT as required. See Appendix A.

2.4.5 Audio Panel interface

The PDA360EX is designed to interface with standard aircraft avionics, and presents a 510 Ω receiver impedance. For best results, a twisted-shielded cable is recommended from the avionics audio source to the audio panel, with the shield grounded at the audio panel end.

Some avionics do not provide a separate audio low, and may introduce additional electrical noise into the system. For best results, connect the audio low from the audio panel to the radio ground, using one conductor of the twisted-shielded cable.

2.4.5.1 Speaker Load

The PDA360EX **does not** contain any resistive speaker loads.

Some older aviation radios units with internal speaker amplifiers, require a resistive load if their speaker amplifier is not used. If needed, connect the radio speaker output from the transceiver to a 16Ω, 3W resistor in the harness.

2.4.5.2 Installation with Monaural Headsets

Not recommended, because the benefit of IntelliAudio is lost. However, if desired, the PDA360EX can be installed monaurally by using the LEFT audio connections only (left side contains Fail-Safe audio). Do NOT short left and right together.

NOTE: Mono headsets that short the tip and ring (i.e. older models) will introduce audio distortion when used. Modern, stereo headsets are recommended in all positions.



2.4.6 Transmit Interlock

Some communications transceivers use a transmit-interlock system. To fully utilize the Split Mode feature, this function must be disabled. Consult the radio manufacturer's installation manual.

2.4.7 Backlighting

The PDA360EX has an automatic dimming of the pushbutton annunciation LEDs controlled by a photocell. Control of the unit nomenclature backlighting is through the aircraft avionics dimmer. For 14 V aircraft, connect J2 Pins 6 and 7 to the aircraft dimmer bus, and pin 5 to ground. For 28-volt systems, connect pin 7 to the aircraft dimmer, and pins 5 and 6 to ground.

If an external dimmer control is **not** used, a constant back light illumination can be established for nighttime viewing. Pin 6 or 7 (depending on system voltage) must be tied to power (J2, pin 8 or 9) for the back lighting system to work. The photocell mounted in the unit face will automatically adjust the intensity of the push-button annunciator LEDs.

2.4.8 Unswitched inputs

J1, pins 31 (Unsw 1), 44 (Unsw 2) 29 (Unsw 3) and J2 pin 15 (Unsw 4) are unswitched, unmuted (by transmitter keying), inputs.

These inputs are presented to the pilot and copilot regardless of the audio configuration, and will always mute the crew entertainment inputs. These 510 inputs can be used for altimeter DH audio, GPS waypoint audio, autopilot disconnect tones, or any other critical audio signal.

Unswitched #1 is available to the pilot in fail-safe (off) mode.

Unswitched 1, 2, 3 and 4 are always presented to the crew headphones.

Unswitched Input	Hear in Fail Safe	Hear in Crew Headset	Adjustable at installation
1	Yes	Yes	No
2	No	Yes	No
3	No	Yes	Yes
4	No	Yes	Yes

Table 2-3 Unswitched inputs

The audio low for unswitched #4 (J2, pin 15) should be connected to a convenient audio low. However, this should NOT be connected to Music Low.

NOTE

Inputs 1 and 2 are fixed (1:1), and any audio level adjustments must be made at the input source. Unswitched #3 and #4 can be adjusted at installation. Refer to Adjustments §2.7.

2.4.9 "Swap" Mode

When a momentary, normally open, push-button switch is connected between pin 20 on the J2 connector and aircraft ground, the user can switch between Com 1 and 2 by depressing this switch without having to turn the mic selector switch. This yoke-mounted switch eliminates the need to remove your hands from the yoke to change transceivers. The transfer of TX indication from Com 1 to Com 2 shows that the swap has been initiated; there is no dedicated swap indicator.

2.4.9.1 Cell phone Sidetone

The PDA360EX can provide cellular telephone sidetone (the user's voice fed back to the headset). Some cell phones provide sidetone, and may have poor audio quality if both sources are combined. The cell phone sidetone is adjustable in the Bluetooth® operation screen [See §2.7](#).

NOTE

Unauthorized use of unapproved cellular telephone devices in aircraft is subject to FCC enforcement action, which may include a \$10,000 fine per incident.
FCC Regulation 47 CFR § 22.925 *Prohibition on airborne operation of cellular telephones*.
Cellular telephones installed in or carried aboard airplanes, balloons or any other type of aircraft must not be operated while such aircraft are airborne (not touching the ground). When any aircraft leaves the ground, all cellular telephones on board that aircraft must be turned off.
PS Engineering, Inc. does not endorse using unapproved cellular telephone equipment in flight, and takes no responsibility for the user's action.
PS Engineering does not guarantee compatibility with personal cellular telephones.

2.5 Intercom wiring

See Appendix C and D for intercom connection configurations. It is critical to the proper operation of this system to have this connector wiring made in accordance with these diagrams. Use 2- and 3-conductor, MIL-spec cable as shown. Connect the shields at the audio panel end only, and tie to the audio low inputs as shown.

NOTE

The intercom harness can be custom made by PS Engineering, Inc. Simply call the factory or www.ps-engineering.com to obtain a wire harness work sheet. The harness will be made to your specifications and fully functionally tested. Harness can be ordered with jack, or without the intercom jacks installed, for easier wire routing through the aircraft.

2.5.1 Music Inputs

The PDA360EX has two INDEPENDENT music inputs. Music input number 1 is J2 pins 23 (left channel) and 24 (right channel), with respect to pin 25, and Music number 2 is connected to 26 (left channel), 27 (right channel), with respect to 28.

PDA360EX has Bluetooth® connectivity to stream music from a paired device. This stream is distributed as Music 1 and is connected in parallel with Music number 1. Refer to [§3.9](#) for more information.

NOTE

Use the low level output of any additional Music device to connect to the audio panel. Maximum signal level is **3 VAC** p-p. **DO NOT** use a speaker-level output, this will cause internal damage in the audio panel.

CAUTION

Local oscillators and internal signals from Music equipment can cause undesired interference with other aircraft systems. Before takeoff, operate the entertainment devices to determine if there is any adverse ef-

fect within the aircraft systems. If any unusual operation is noted in flight, immediately switch off the entertainment devices.

All additional entertainment devices must be switched off for both takeoff and landing.

2.5.1.1 Music 2 Mute (J2 Pin 13 & 14)

Connecting J2 pin 13 to pin 14 (or ground) through a SPST switch places the Music #2 music source into the Karaoke Mode. In this mode, incoming music and intercom conversation will not mute the music for the passengers' intercom net. This is useful for passenger-area control of the music muting, and overrides the menu-controlled setting.

However, Music 2 Mute control is also available in the PDA360EX Music Mute Menu.

2.5.2 Wires telephone/Satcom input

An input is available for connection to wired telephone and Satellite com radios.

Connect J1 Pin 3 to the audio output, Pin 5 to the telephone microphone input, and Pin 4 as the audio low.

2.5.3 Playback button Installation

The pilot and copilot can hear the aircraft radio playback.

The Internal Recorder System can be played back from the front panel by pressing the RCV button of the radio selected for transmission.

Or a remote, momentary, normally open (NO) push button switch may be installed if desired to activate the Recording System playback. This switch can be located anywhere in cockpit convenient to the pilot's reach. The NO switch should be connected to pin 22 of J2 of the PDA360EX, and ground. When installed, this button will act as in §3.12.

2.6 User Adjustments

To access the user adjustment menus, turn the PDA360EX off, and then back on. While the **version** screen is displayed, push and hold the bottom line-select button (there is an indicator bar in the display indicating that a menu is available). This places the unit into the "User Configurable Mode – home screen". This allows adjustment for:

- LCD Screen Adjustment
- Rename Switched Inputs
- Bluetooth menus

Note: in this mode, the audio panel functions will be inoperative



2.6.1 Adjust Screen

The first items are adjustments to the Liquid Crystal Display, allowing the installer or user to tailor the contrast and backlight intensity to suit the cockpit conditions, and set the time period before the menus revert to the "home" screen.

There are two screen visibility modes: LCD Brightness & LCD Contrast.

2.6.1.1 Brightness and Contrast

Adjusting either the Brightness or Contrast level requires selecting either of the two line select buttons and then turning the inner knob. Counter clockwise to lower the number (level of Brightness & Contrast) and clockwise to increase the number (level of Brightness & Contrast).

To change the display:

Press the line select for the desired item

Turn the small, inner knob to change the contrast and brightness as desired. Recommended settings are Brightness 10, and Contrast 5.

LCD will change in real time while adjustments are made.

It will stay in this screen until the menu times out and returns to the adjustment home screen.

2.6.1.2 Display Timeout

This is a feature that allows the end user to adjust how quickly the screen levels menus timeout (revert to main menu).

This allows adjustment of the timeout screen and can be configured from 1 second to 30 seconds when turning the inner knob.

For a user that is unfamiliar with the product, this will give them enough time to learn the system. After being familiar then the user can speed up the timeout screen as needed.

It will stay in this screen until the menu times out and returns to the adjustment home screen.

To exit the home screen and return to normal operation, turn the PDA360EX off, and back on again.

2.6.2 Rename “Switched” Inputs

The system is factory set to default as ADF, DME & AUX as shown.

The three inputs are from top to bottom:

1. Switched input #1 J1, Pin 7 wrt Pin 8 (Default ADF)
2. Switched input #2 J1, Pin 21 wrt Pin 22 (Default DME)
3. Switched input #3 J1, Pin 23 wrt Pin 43 (Default AUX).

The customer will have access to rename. Maximum 9 letters per line and *A thru Z & 0 thru 9* will be available.

- Press the line select for desired input.
- Turn the large outer knob to select the letter to change. A cursor appears under the active letter position.
- Turn the small, inner knob to increment or decrement the letter.
- You can select 9 alphanumeric digits.
- To add a blank space:
 - Blank spaces can't be added to the end of a string, but you can add a temporary character and go back and change it to a space:
 - TACARADIOA1
 - Change extra “A”s to spaces TAC RAD 1

It will stay in this screen until the menu times out and returns to the adjustment home screen.

Cycle PDA360EX power to exit the setup screen.

2.6.3 Bluetooth® menu

The Bluetooth menu allows the user to:

- Reset (remove) all paired devices
- Set a pairing pass code
- Change the PDA360EX's device ID

2.6.3.1 Un-pair All

Pressing the line select next to Un-pair All removes all Bluetooth devices. This is used when the pairing of devices becomes unreliable.

2.6.3.2 Pair:

This allows the user to set any desired pass code that users will use to pair Bluetooth devices. Four digits, 1 to 9 can be used.

2.6.3.3 ID:

This allows the user to set the name of the audio panel as it will appear on devices searching for the PDA360EX. Seven alphanumeric digits are available. Factory default is PDA360EX, but you could set "N1245," or "Skyhawk, as an example."

2.7 Communications Antenna Installation Notes

For best results while in Split Mode, it is recommended that the one VHF communications antenna is located on top of the aircraft while the other communications antenna is installed on the bottom. Any antenna relocation must be accomplished in accordance with AC 43.13-2B, aircraft manufacturers' recommendations and FAA-approved technical data.

WARNING

It is probable that radio interference will occur in the split mode when the frequencies of the two aircraft radios are adjacent, and/or the antennas are physically close together. **PS Engineering makes no expressed or implied warranties regarding the suitability of the PDA360EX in Split Mode.**

2.8 PDA360EX Pin assignments

J1	Function	J2	Function
1	No Connect	1	Pilot Phones Lo
2	No Connect	2	Copilot Phones Lo
3	No Connect	3	Copilot Phones (L)
4	No Connect	4	Copilot Phones (R)
5	No Connect	5	Lights lo
6	No Connect	6	14/28 V Lights
7	SW#1 (ADF Audio) In	7	14/28 V Lights
8	SW#1 (ADF Audio) Lo	8	Aircraft Power
9	Com 1 Audio	9	Aircraft Power
10	Com 1 Audio Lo	10	Aircraft Ground
11	Com 1 Mic	11	Aircraft Ground
12	Com 1 Mic Key	12	PA Mute
13	Com 2 Audio	13	Mute Inhibit
14	Com 2 Audio Lo	14	Mute Inhibit Lo
15	Com 2 Mic	15	Unswitched #4
16	No Connect	16	Pilot Phones (L)
17	Nav 1 Audio	17	No Connect
18	Nav 1 Audio Lo	18	RESERVED
19	Nav 2 Audio	19	PA Enable Out
20	Nav 2 Audio Lo	20	Swap
21	SW#2 (DME) Audio	21	Swap Lo
22	SW#2 (DME) Audio Lo	22	IRS Playback
23	SW#3 (Aux) Audio	23	Music 1 (L)
24	CNX80 Inhibit	24	Music 1 (R)
25	No Connect	25	Music 1 Lo
26	No Connect	26	Music 2 (L)
27	No Connect	27	Music 2 (R)
28	No Connect	28	Music 2 Lo
29	Unswitched #3	29	No Connect
30	Com 2 Mic Key	30	RESERVED
31	Unswitched Audio 1	31	Pilot Phones (Rt)
32	Unswitched Lo	32	Copilot Mic Audio
33	Pilot Mic Audio	33	Copilot Mic PTT
34	Pilot Mic PTT	34	Copilot Mic Lo
35	Pilot Mic Lo	35	Pass 1 Mic Audio
36	No Connect	36	Pass 1 Mic Audio Lo
37	No Connect	37	Pass 2 Mic Audio
38	No Connect	38	Pass 2 Mic Audio Lo
39	No Connect	39	Pass 3 Mic Audio
40	Pass HP (L)	40	Pass 3 Mic Audio Lo
41	Pass HP (R)	41	Pass 4 Mic Audio
42	Pass HP Lo	42	Pass 4 Mic Audio Lo
43	Unswitched 2 Lo	43	No Connect
44	Unswitched 2 Audio	44	No Connect

Table 2-4: PDA360EX Pin Assignments

2.9 Wiring Checkout

After wiring is complete, verify power is **ONLY** on pins 8 and 9 of the J2 and airframe ground on connector pins 10 and 11. Failure to do so will cause serious internal damage and void PS Engineering's warranty.

2.10 Unit Installation

To install the PDA360EX, gently slide the unit into the mounting rack until the hold-down screw is engaged. While applying gentle pressure to the face of the unit, tighten the 3/32" hex-head in the center of the unit until it is secure. **DO NOT OVER TIGHTEN.**

CAUTION

Apply steady pressure to the bezel while screwing the unit into the tray to ensure even seating of the unit and connectors. **WARNING** Do not over-tighten the lock down screw while installing the unit in tray. **Internal damage will result.**

2.11 Operational Checkout

2.11.1 Audio Panel Test

NOTE

The *IntelliVox*® is designed for ambient noise levels of 80 dB or above. Therefore some clipping may occur in a quiet cabin, such as without the engine running, in a hangar. This is normal. Use of a Stereo headset is **required** to obtain full effect of IntelliAudio processing in the crew positions.

1. Apply power to the aircraft and avionics.
2. Plug **stereo** headsets into the pilot, copilot, and occupied passenger positions.
3. Verify fail-safe operation by receiving and transmitting on com 1 from the pilot position, with the audio panel power off. The Com audio will be present in one ear cup only.
4. Switch on the unit by pressing the volume (VOL) knob.
5. Check intercom operation.
6. Push the C1 Xmt select button (lower row).
7. Verify that both of the **C1** indicators light. Verify that transmit button LED (Light Emitting Diode) near the mic selector is not blinking. If the LED is blinking, stop testing and troubleshoot the microphone PTT installation.
8. Verify proper transmit and receive operation from the copilot position, noting that the copilot PTT switch allows proper transmission on the selected transceiver. Verify that the C1 Xmt button blinks when transmitting.
9. Verify that pushing the **C2** button causes the button to illuminate, and the Com 2 receiver to be heard. Verify operation on Com 1 from the pilot position.
10. Repeat for Com 2
11. Press and hold the C1 Xmt button. While holding the C1 button, press the C2 Xmt button. This places the unit in "Split Mode;" Verify that the pilot can transmit and receive on Com 1, while the copilot transmits and receives on Com 2.
12. Verify proper operation of all receiver sources by selecting them using the appropriate button or menu.
13. Verify that the appropriate LED in the lower button row blinks when either push to talk is keyed.
14. Verify proper Intercom system operation in the **ALL**, **ISO** and **CREW** modes (see Table 3-1).
15. Verify that the audio selector panel system does not adversely affect any other aircraft system by systematically switching the unit on and off, while monitoring the other avionics and electrical equipment on the aircraft.

2.11.2 Bluetooth Checkout

Verify that the PDA360EX will "pair" with a Bluetooth device, and interface with cellular phone and Music source. See section 3.12 for more information.

2.11.2.1 TEL Checkout

Pair the PDA360EX with a Bluetooth telephone device. Verify that the pilot headset is connected to the cellular telephone system (if installed). Verify that by using the pilot side PTT, the pilot can transmit on the other selected radio (Com 1 or Com 2). The telephone function will allow any person heard by the pilot on the intercom, also heard on the telephone.

2.11.3 Internal Recorder Checkout

With headset plugged into pilot's side jacks, tune COM 1 to local frequency, such as FSS or ATC ground. Select Com 1 on mic selector switch, and record several incoming radio transmissions.

Press the Com receiver pushbutton (C1 or C2) that corresponds to the selected radio transmitter and *hold* for approximately one second. This action will then automatically play back the last recorded message. Press and HOLD the button again to stop the play back, and then momentarily press again to play prior messages.

This audio should appear in the pilot and copilot headsets, and only be incoming transmissions from the transceiver selected in the mic select switch. Depress the audio panel or yoke mounted playback switch, and verify that messages play, in the order received. Repeat for other COM. The playback will be stopped by audio on the selected com. The message can be replayed from the beginning, and audio received during the playback will not be stored.

2.12 Final Inspection

Verify that the wiring is bundled away from all controls and no part of the installation interferes with aircraft control operation. Move all controls through their full range while examining the installation to see that no mechanical interference exists. Verify that the cables are secured to the aircraft structure in accordance with good practices, with adequate strain relief. Ensure that there are no kinks or sharp bends in the cables and coaxial cables. Verify that the cables are not exposed to any sharp edges or rough surfaces, and that all contact points are protected from abrasion.

Complete documentation that may be required, such as a logbook entry, weight and balance computation. Return completed warranty registration application to PS Engineering, or complete online at www.ps-engineering.com.

Section III OPERATION

3.1 SCOPE

This section provides detailed operating instructions for the PS Engineering PDA360EX, Audio Selector Panel/Intercom Systems. Please read it carefully before using the equipment so that you can take full advantage of its capabilities.

This section is divided into sections covering the basic operating areas of the PDA360EX systems. They are Communications Transceiver Selection, Audio Selector, Intercom, and special functions, including the Bluetooth® functionality in the PDA360EX.



Figure 3-1 PDA360EX Operating Controls

3.2 Power and Fail Safe (1)

Unit power is turned on and off by pushing the volume knob (1). There is a built in delay to prevent accidental shut off while adjusting the intercom volume in turbulent conditions. In the OFF or "EMG" position, the pilot headset is connected directly to Com 1 as well as unswitched input #1. This allows communication capability regardless of unit condition. Any time power is removed or turned OFF, the audio selector will revert to fail-safe mode.

The power switch controls all audio selector panel functions and intercom. All transceiver and receiver selections will be remembered and return to the last state when turned on.

Unit power is turned on and off by pushing the volume knob (1). There is a built in delay to prevent accidental turn off.

3.3 Menu Selection (6)

The PDA360EX uses a Liquid Crystal Display and three line-select buttons to access advanced functionality in a very logical manner. Press the line select key to select a specific item on each menu. Items are toggled on and off by pressing the line select key as well.



When navigating the menus, the screen will automatically return to this "home" screen after a period of inactivity. This delay time is configurable from the initialization menu as well, for between 1 and 30 seconds.

A vertical **bar** next to a button, indicates the button can perform a function on that menu.

A **split bar** indicates that a secondary function is available when that button is held for more than one second.



Figure 3-2 Top level Menu

3.4 Communications Transmit (XMT) Selection (2)

The PDA360EX has four buttons to select communications transceiver functions, two each C1 and C2. C1 refers to VHF COM 1, and C2, to VHF COM 2. To select a VHF COM for transmit; push the lower button in the XMT (transmit) section. The radio is automatically selected to receive incoming radio calls when the XMT is selected. With a PDA360EX, you will *never* transmit on a radio that you are not receiving.

To select a VHF COM radio to listen only, push the C1 or C2 button in the RCV (Receive) section.

The PDA360EX will remember when you have selected a radio for receive only, and then switch to it for transmission and switch back.

3.4.1 Split Mode

In the SPLIT mode, the pilot position transmits and receives on COM 1, and the copilot can transmit and receive on COM 2 independently.

Pressing the C1 and C2 XMT buttons (above the SPLIT legend), puts the PDA360EX into SPLIT com mode.



In split mode:

Position	COM 1 Receive	COM 1 Transmit	COM 2 Receive	COM 2 Transmit	Switched Audio	Unsw. Audio	Copilot Intercom	Passenger Intercom
Pilot	Yes	Yes	NO	NO	Yes	Yes	NO	NO
Copilot	NO	NO	Yes	Yes	NO	Yes	NO	NO
Passengers	NO	NO	NO	NO	NO	NO	NO	YES

- The intercom is deactivated automatically when you enter SPLIT mode.
 - Push the ICS button until the green LED lights up CRW to restore intercom between pilot and copilot.
 - Intercom between crew and passengers is not possible in split mode
- *The spatial component of IntelliAudio is defeated in split mode.*
- To exit SPLIT mode, reselect C1 or C2 XMT button

3.5 COM Audio Selector (3)

Communication audio from the other radio, not selected for transmit, can be heard by pressing the associated RCV button. You will always hear the audio from the selected transceiver.

3.5.1 Swap Mode (Switch from Com 1 to Com 2 remotely)

With an optional yoke mounted, normally open momentary switch, the pilot can change from the current Com transceiver to the other by pressing this switch. To cancel "Swap Mode," either press the yoke mounted switch again, or select a different Com with the XMT buttons.

3.5.2 IntelliAudio® Dimensional Audio

Various audio signals are presented to the DSP and processed to “appear” in a different location to the crew. “Multi-Talker” (US Patent #7,391,877) specifies up to nine locations. This helps the crew to better comprehend speech by locating it in a manner easier differentiated by the human brain.

Intercom and other audio is not spatially processed, only the pilot and copilot VHF COM audio.

The spatially processed dimensional sound in the PDA360EX can be adjusted to accommodate the user preferences.

This adjustment allows the Spatial Audio inputs to be “relocated” on any of nine (9) defined “Head Related Transfer Function” (HTRF) locations.

Push **IntelliAudio** **IntelliAudio Config** to access. In the IntelliAudio® mode, repeated pressing of the COM 1 or COM 2 line select buttons moves the corresponding half-circle cursor to the locations relative to the listener graphic in sequence.

Pressing the **Done** button exits the configuration setting mode. This setting is recalled at system power up.

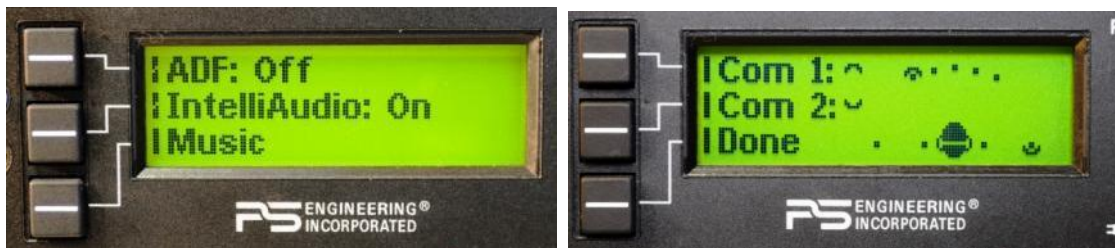
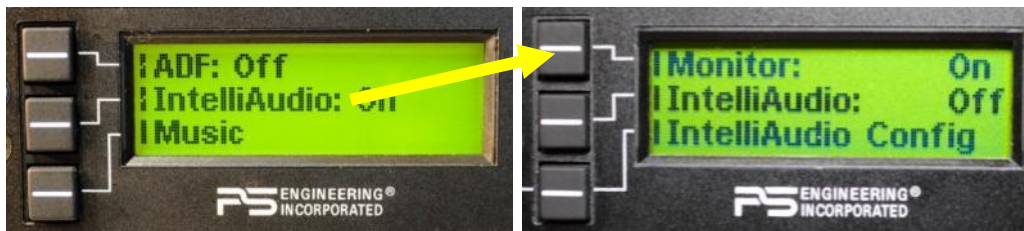

Figure 3-3 IntelliAudio – True Dimensional Sound, Spatial Location Display, showing C1 at 30° left and C2 at 90° right of center.

3.5.3 Com Monitor Mode

The PDA360EX is equipped with a Monitor function, which allows a secondary com radio audio to be muted by the primary radio (selected for transmit).

To toggle the Monitor mode on and off, Press **IntelliAudio** **MONITOR**



NOTE: Monitor Mode and Spatial Audio Processing (IntelliAudio) are mutually exclusive – entering one mode will cancel the other.

3.5.4 Navaid Selection (4)

VHF Navigation receivers can be selected directly from the front panel with the N1 and N2 (VHF Navigation receiver 1 and 2) buttons. The selected source is indicated by a green LED.

One other navigation receiver, such as ADF, DME can be turned on and off from the main menu. The name of this receiver can be changed from the user setup menu. The top receiver appears on this menu.



Additional navigation aid or other audio sources can be selected using the LCD menus.

Press the top line select **RADIO SWITCHED INPUTS**, and desired audio source.

NOTE: If no other navigation radios or audio sources are installed, the top line of the menu can be turned off. See set up for more information.

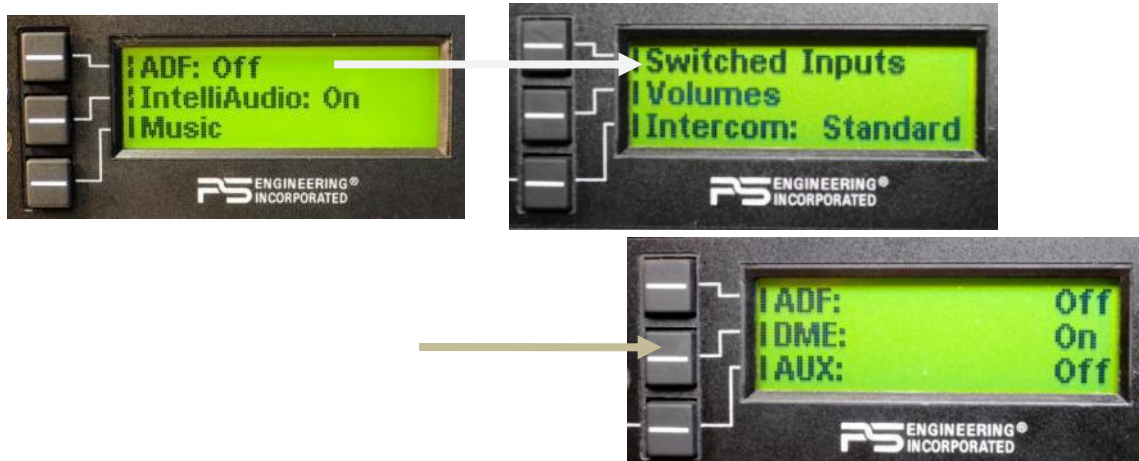

NOTE: Switched Inputs can be renamed at the configuration set up. See §3.13 for more information.
In *SPLIT* mode, only the pilot will hear selected navigation audio.

3.6 Intercom Operation (8)

3.6.1 IntelliVox® Intercom VOX-Squelch

No adjustment of the *IntelliVox*® squelch control is necessary. Through three individual signal processors, the ambient noise appearing in all four microphones is constantly being sampled. Non-voice signals are blocked. When someone speaks, only their microphone circuit opens, placing their voice on the intercom.

The system is designed to block continuous tones; therefore people humming or whistling in monotone may be blocked after a few moments.

For consistent performance, any headset microphone **must** be placed within ¼-inch of your lips, preferably against them. (ref: *RTCA/DO-214, 1.3.1.1 (a)*).

NOTE

It is also a good idea to keep the microphone out of a direct wind path. Moving your head through a vent air stream may cause the *IntelliVox*® to open momentarily. This is normal.

The *IntelliVox*® is designed to work with normal aircraft cabin noise levels (70 dB and above). It loves airplane noise! Therefore, it may not recognize speech and clip syllables in a quiet cabin, such as in the hangar, or without the engine running. This is normal.

For optimum microphone performance, PS Engineering recommends installation of a Microphone Muff Kit from Oregon Aero (1-800-888-6910). This will not only optimize VOX performance, but will improve the overall clarity of *all* your communications.

Manufacturer	Model	Mic Muff™ Part Number
Bose	Dynamic	90010
	Electret	90015
	M87 Dynamic	90020
David Clark	H10-30	90010
	H10-20, H10-40	90015
	H10-13.4	90015
Lightspeed	All	90015
Peltor	7003	90010
	7004	90015
Pilot	11-20 & 11-90	90015
Sennheiser		90015
Telex	Airman 750, Echelon	90015
	AIR3000	90010

Table 3-1 Mic Muff™ Part Numbers

3.6.2 Intercom Volume Control (1)

The smaller inner volume control knob adjusts the loudness of the intercom for the pilot and copilot. It has no effect on selected radio levels, music input levels or passengers' volume level. The green volume bar indicator shows the level of the crew volume by default.

The outer, larger volume control knob controls intercom volume for the passengers. It has no effect on radio or music levels. When the outer knob is moved, the green volume bar indicator will switch to show the level of the passenger's intercom volume, reverting to the crew after a few seconds.

Adjust the radios (at the radio itself) and intercom volume for a comfortable listening level. Most general aviation headsets today have built-in volume controls; therefore, volume also can be further adjusted at the individual headset.

3.6.2.1 Monaural headsets

The pilot and copilot positions work with stereo or mono headsets. However, IntelliAudio will not be presented correctly unless stereo headsets are used, and oriented correctly on the head, left and right.

NOTE: For the full effect of IntelliAudio® Dimensional Sound, stereo headsets must be used, and the left/right orientation observed.



All *passenger* headsets are connected in parallel. Therefore, if a monaural headset is plugged in to a PDA360EX Stereo installation, one channel will be shorted. Although no damage to the unit will occur, all passengers with stereo headsets will not hear one channel, unless they switch to the "MONO" mode on their headset.



NOTE: Mono headsets that short the tip and ring (i.e. older models) will introduce some audio distortion when used. Modern, stereo headsets are recommended in all positions.

3.6.3 Intercom Modes (8)

The "ICS" pushbutton switch on the panel provides the selection of the three intercom modes. The description of the intercom mode function is valid only when the unit is not in the "Split" mode. Then, the pilot and copilot intercom is controlled by the ICS button selecting CRW.

This button cycles through the intercom modes, from left to right, then right to left as: ISO, ALL CRW and CRW, ALL, ISO. A green indicator shows which mode is currently active.

ISO: The pilot is isolated from the intercom and is connected only to the aircraft radio system. He will hear the aircraft radio reception (and sidetone during radio transmissions). Copilot will hear passengers' intercom and Music, while passengers will hear copilot intercom and Music. Neither will hear aircraft radio receptions or pilot transmissions. The pilot can hear music if desired. See [§3.9.3](#)

ALL: All parties will hear the aircraft radio and intercom. Crew and passengers will hear selected Music. During any radio or intercom communications, the music volume automatically decreases. The music volume increases gradually back to the original level after communications have been completed.

CREW: Pilot and copilot are connected on one intercom channel and have exclusive access to the aircraft radios. They may also listen to Music 1. Passengers can continue to communicate with themselves without interrupting the Crew and may listen to Music as configured.

3.7 Music and Music Muting

The PDA360EX has two independent music inputs at the rear connector, and a front panel jack. The PDA360EX also has the ability to receive streaming music from a Bluetooth-enabled device which will be connected into Music #1.

The Music 1 and Music 2 inputs can be selectively delivered to the pilot, copilot and/or passengers using the music distribution menu.

Streaming Bluetooth® Music is in parallel with Music 1

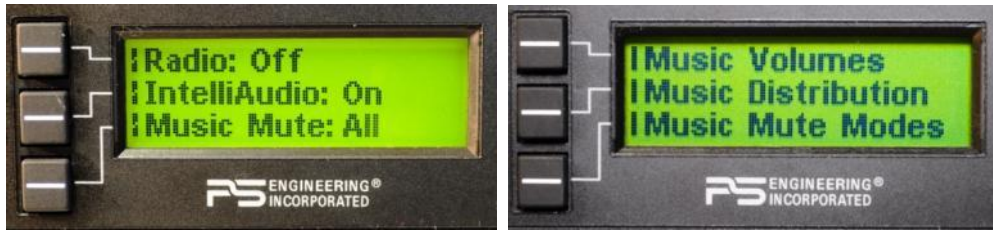

Figure 3-4 Top Music Menu

Press Music Music Distribution and select desired combination.

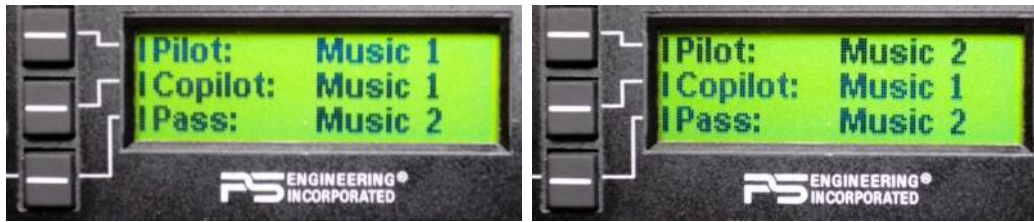

Figure 3-5 Music distribution menu

NOTE:

All music devices should be turned off for takeoff, landing, or any critical phase of flight. FAA Regulation 14 CFR 91.21 restricts the use of portable electronic devices.

§91.21 “(a) Except as provided in paragraph (b) of this section, no person may operate, nor may any operator or pilot in command of an aircraft allow the operation of, any portable electronic device on any of the following U.S.-registered civil aircraft. . .

“(b)(5) Any other portable electronic device that the operator of the aircraft has determined will not cause interference with the navigation or communication system of the aircraft on which it is to be used.”

You can refer to Advisory Circular 91.21-1A for more information, at <http://www.faa.gov>

3.7.1 Music Muting

The SoftMute™ circuit will mute the music whenever there is conversation on the radio, the intercom, or both, depending on the “Mute” mode selected. When that conversation stops, the music returns to the previous level comfortably, over a second or so.

The mute mode functions are controlled through Music Mute Menu which has **three** modes for each music input. Mute ALL, Karaoke & Radio Mute.



The PDA360EX always defaults to *Mute ALL* when turned on.

In Mute- music **will** mute with *either* intercom *or* radio

“Karaoke” mode - music will not mute except during radio transmissions.

Radio (Rad) Mute - *Radio* will mute music, but intercom will **not** mute music.



In addition to the panel mute menu, a remote switch may be installed to allow the passengers local access to their Karaoke mode. When this switch is grounded, the menu choice is overridden.

3.7.2 Music Volume

The volume of the music inputs can also be adjusted from the menu of the PDA360EX:

Press Music Music Volume Desired music input. The LED Volume bar and the numeric volume will show the volume level.



Figure 6 – Music Volume screen

3.7.3 Music in Pilot ISO mode

When the isolate (ISO) mode is activated, the music for the pilot is automatically disabled. If desired, the pilot can elect to hear Music #1, in the ISO mode by selecting through the menu screen.



The pilot can select either music source from the Music distribution menu.

3.8 Bluetooth® connection

The PDA360EX has a Bluetooth interface. The audio panel is always “discoverable,” so you just need to search for the PDA360EX from your Bluetooth-equipped phone or music source. The default access code is 0000, if needed. Once the PDA360EX has been “paired” with your Bluetooth device, the TEL distribution will act as described in § 3.11.1.



When Bluetooth is active, a Bluetooth icon and the battery status of the device is displayed in the upper right corner of the home display.

3.8.1 Pairing and unpairing Bluetooth devices

The PDA360EX can be paired with up to eight individual devices. When that number is exceeded, the PDA360EX will randomly drop a device to allow the new device to be added.

Hint, if your old phone is not recognized by the PDA360EX, you may need to reset from the Bluetooth menu.

3.8.1.1 Pairing separate music and telephone devices

It is possible to use a different music source (iPad, iPod with Bluetooth adapter, Bluetooth enabled laptop, etc) and telephone. However, only one music source can be streaming at a time.

3.9 Bluetooth® Telephone Mode

The PDA360EX serves as a full duplex interface for telephone systems such as portable cellular phones with Bluetooth connectivity.

Warning:

United States FCC Regulations contained in 47 CFR § 22.925 currently contain prohibition on airborne operation of cellular telephones. "Cellular telephones installed in or carried aboard airplanes, balloons or any other type of aircraft must not be operated while such aircraft are airborne (not touching the ground). When any aircraft leaves the ground, all cellular telephones on board that aircraft must be turned off."

In **ALL** intercom mode, all crew and passengers will be heard on the phone when they speak. All will hear selected audio. Com audio is automatically heard in the headsets.

In **CREW** mode, the pilot and copilot are connected to the telephone. The pilot and copilot will have transmit capability on the other selected transceiver Com 1 or 2, simply by using their respective PTT switch.

In **ISO** intercom mode, when the PDA360EX is in the **TEL** mode, the pilot position is in the "Phone Booth." Only the pilot will hear the telephone, and only he will be heard. He will also have access to Com 1 or 2, and will transmit on that radio using the PTT. All selected audio is provided.

NOTE

Because the cell phone uses an intercom circuit, all stations on that circuit will lose intercom capability when the cell phone is in use. Intercom conversations will still be present if the cell phone provides sidetone, or if the audio panel is modified for telephone sidetone.

PS Engineering does not guarantee compatibility with personal cellular telephones.

3.9.1 Cellular telephone sidetone

Some cell phones do provide sidetone, and when combined with unit sidetone can cause audio distortion. In PDA360EX Telephone sidetone can be enabled or disabled on the Telephone menu when a call is active.



3.10 Internal Recorder and playback

The PDA360EX comes equipped with an internal recorder. This digital system stores the last incoming audio from the radio you have selected for transmit. It can store as many of 8 incoming messages, and up to 45 seconds of audio. The pilot and copilot hear the playback.

Recording is automatic. To play back the last recorded message, press and hold the COM Receive pushbutton associated with the selected radio transmitter for about one (1) second. You can either wait for the message to finish playing before accessing the prior message, or cancel the current playback and step backward. To cancel the playback, press and hold the COM receive playback button for two seconds (2). The next time the button is pressed for one (1) second, the next earlier message will be heard. The playback will stop whenever there is more incoming selected com audio, and the message can be replayed from the beginning by pressing the selected Com Receive button again for 1 second.



Figure 3-7 Playback Controls



Figure 3-8 Playback Display

3.11 User Setup menus

The PDA360EX has several user adjustable functions accessible from a setup menu.

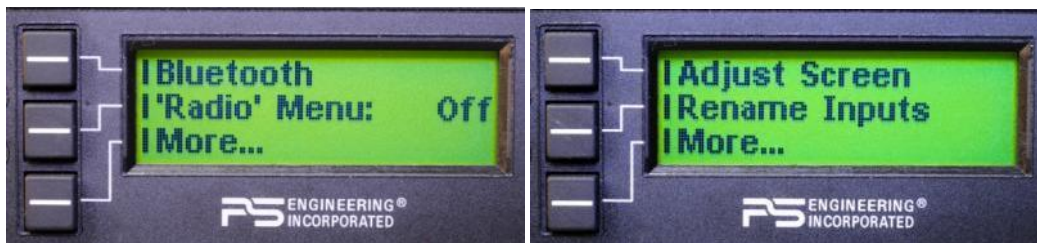

Figure 3-9 User Configuration Menus

During the unit boot up process, hold the lower line select button until the setup screen appears.

Cycle the PDA360EX power to exit setup screen.

During the unit boot up process, hold the lower line select button until the setup screen appears. This shall place the unit into the "User Configurable Mode- home screen". This allows adjustment for:

- • Adjust Screen (LCD)
- • Rename Switched Inputs
- • Bluetooth

Cycle the PDA360EX power to exit setup screen.

3.12 LCD Adjustment

The first items are adjustments to the Liquid Crystal Display, allowing the installer or user to tailor the contrast and backlight intensity to suit the cockpit conditions.

There are two modes: LCD Brightness & LCD Contrast.

LCD will vary in real time while adjustments are made. LED bar & numeric indication will vary.

Adjusting either the Brightness or Contrast level requires selecting either of the two smaller buttons and then turning the inner knob. Counter clockwise to lower the number (level of Brightness & Contrast) and clockwise to increase the number (level of Brightness & Contrast).

To change the display:

Press the line select for the desired item

Turn the small, inner knob to change the contrast or brightness as desired.

Cycle the PDA360EX power to exit setup screen.



Figure 3-10 LCD Menu

3.12.1 Display Timeout

This is a feature that allows the end user to adjust how quickly the screen menus timeout (revert to main menu).

This allows adjustment of the timeout screen and can be configured from 1 second to 30 seconds by turning the inner knob.

For a user whom is unfamiliar with the product, this will give them enough time to learn the system. After becoming more familiar the user can speed up the menu screen timeout as desired.

Cycle the PDA360EX power to exit setup screen.

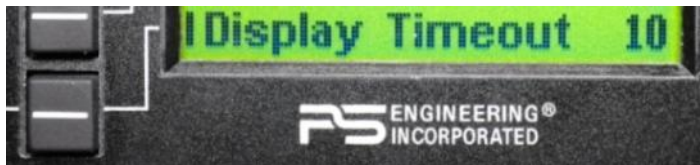

Figure 3-11 Display Timeout Menu

3.12.2 Rename “Switched” Inputs

The system is factory set to default as ADF, DME & AUX as shown.

The three inputs are from top to bottom:

- Switched input #1 J1, Pin 7 wrt Pin 8 (Default ADF)
- Switched input #2 J1, Pin 21 wrt Pin 22 (Default DME)
- Switched input #3 J1, Pin 23 wrt Pin 43(Default AUX)

The customer will have access to rename. Maximum 9 letters per line and *A thru Z & 0 thru 9* will be available.

- Press the line select for desired input.
- Turn the large outer knob to select the letter to change.
- Turn the small, inner knob to increment or decrement the letter.
- You can select 9 characters, A through Z, 1 through 9.
- You can quickly clear the whole line by turning the outer knob to move the cursor all the way to the right until the line clears.

Cycle the PDA360EX power to exit setup screen.

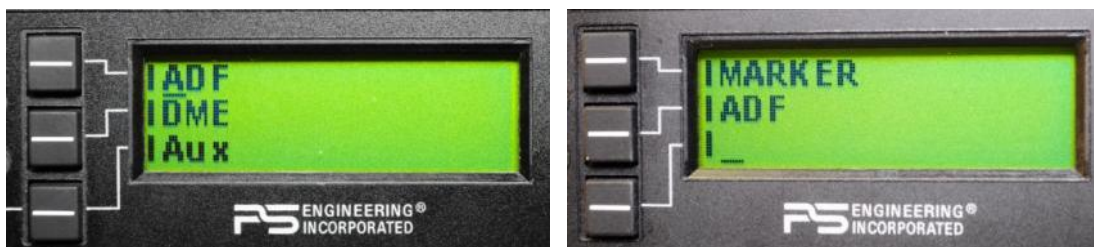

Figure 3-12 Rename Input Menu

3.12.3 “Radio” not present

If no addition navigation receivers or other selected audio sources are installed, the selection can be eliminated from the display. Selecting ‘Radio’ Menu to Off will remove the top line selection.

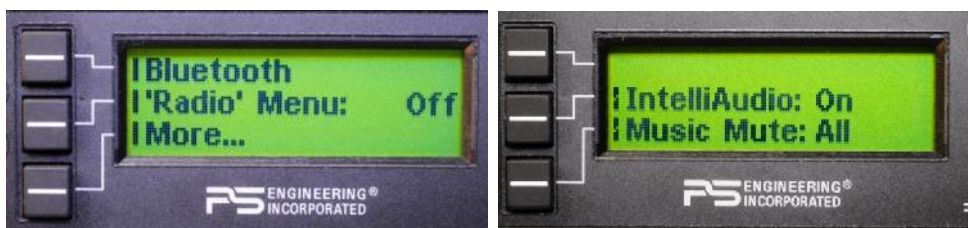

Figure 13 -- Receiver Menu selection

3.12.4 Bluetooth Setup

There are three Bluetooth functions that can be changed in the user setup screen, Unpair All, Paring PIN, and device ID.

When **Unpair All** is pushed, all Bluetooth devices are erased from the audio panel, and can then be added back as desired. This is useful in some cases where the unit or operator lose track of the devices paired, and cannot get them to connect.

Pair: The 4 digit pass code can be changed to any number desired. This is useful if the owner wants to restrict access to the audio panel Bluetooth functions.

ID: The PDA360EX can be renamed using this mode to show up on the devices with a personalized identifier.

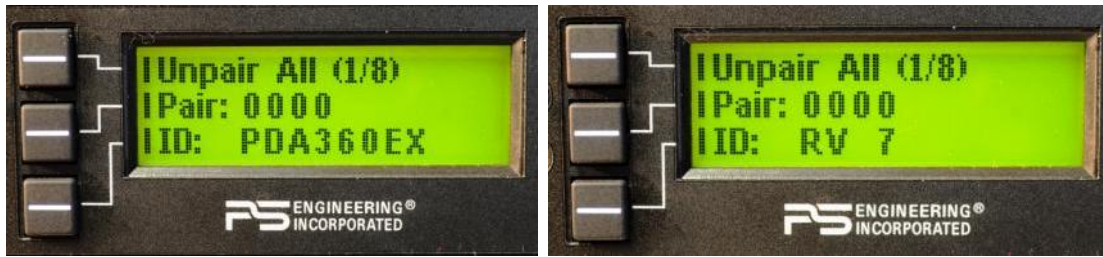

3.13 USB Charging Port (10)

The PDA360EX contains a USB charging port that is capable of providing 5 VDC, 1.5 amps of current to charge the batteries in smart phones and tablets used as Personal Electronic Devices. This is NOT a data transfer jack.

Section IV – Warranty and Service

4.1 Warranty

In order for the factory warranty to be valid, the installations must be accomplished by an FAA-(or other ICAO agency) certified avionics shop and authorized PS Engineering dealer. If the unit is being installed by a non-certified individual, a factory-made intercom harness must be used for the warranty to be valid.

PS Engineering, Inc. warrants this product to be free from defect in material and workmanship for a period of two (2) years from the date of sale. During the first **twelve (12) months** of the two-year warranty period, PS Engineering, Inc., at its option, will send a replacement unit at our expense if the unit should be determined to be defective after consultation with a factory technician. For the remaining **twelve (12) months** of the two-year warranty period, PS Engineering, Inc., at its option, will send a similar replacement unit at the customers' expense if the unit should be determined to be defective after consultation with an authorized PS Engineering dealer.

All transportation charges for returning the defective units are the responsibility of the purchaser. All domestic transportation charges for returning the exchange or repaired unit to the purchaser will be borne by PS Engineering, Inc. The risk of loss or damage to the product is borne by the party making the shipment, unless the purchaser requests a specific method of shipment. In this case, the purchaser assumes the risk of loss.

This warranty is not transferable. Any implied warranties expire at the expiration date of this warranty. PS Engineering SHALL NOT BE LIABLE FOR INCIDENTAL OR CONSEQUENTIAL DAMAGES. This warranty does not cover a defect that has resulted from improper handling, storage or preservation, or unreasonable use or maintenance as determined by us. This warranty is void if there is any attempt to disassemble this product without factory authorization. This warranty gives you specific legal rights, and you may also have other rights, which may vary from state to state. Some states do not allow the exclusion of limitation of incidental or consequential damages, so the above limitation or exclusions may not apply to you.

All items repaired or replaced under this warranty are warranted for the remainder of the original warranty period. PS Engineering, Inc. reserves the rights to make modifications or improvements to the product without obligation to perform like modifications or improvements to previously manufactured products.

4.2 Factory Service

The units are covered by a two-year limited warranty. See warranty information. Call PS Engineering, Inc. at (865) 988-9800 before you return any unit. This will allow the service technician to provide any other suggestions for identifying the problem and recommend possible solutions.

After discussing the problem with the technician and you obtain a Return Authorization Number, ship product to:

PS Engineering, Inc.
Attn: Service Department
9800 Martel Rd
Lenoir City, TN 37772
(865) 988-9800 FAX (865) 988-6619
Email: support@ps-engineering.com

Units that arrive without an RMA number, or telephone number for a responsible contact, will be returned un-repaired. PS Engineering is not responsible for items sent via US Mail.

Appendix A – PDA360EX Installation Drawings

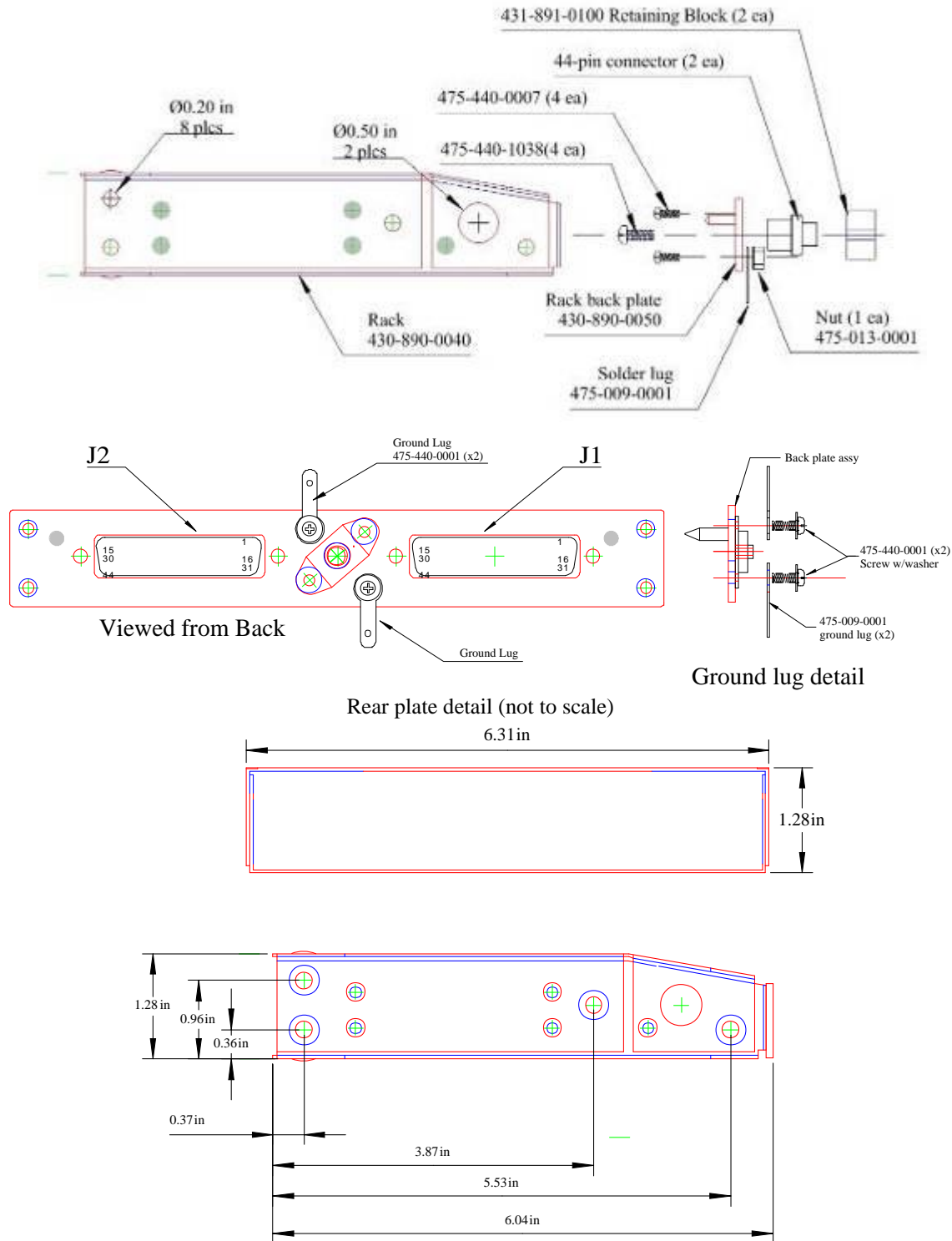

Caution: Apply steady pressure to the bezel while screwing the unit into the tray to ensure even seating of the unit and connectors.

Appendix B – J1 Connector Interconnect

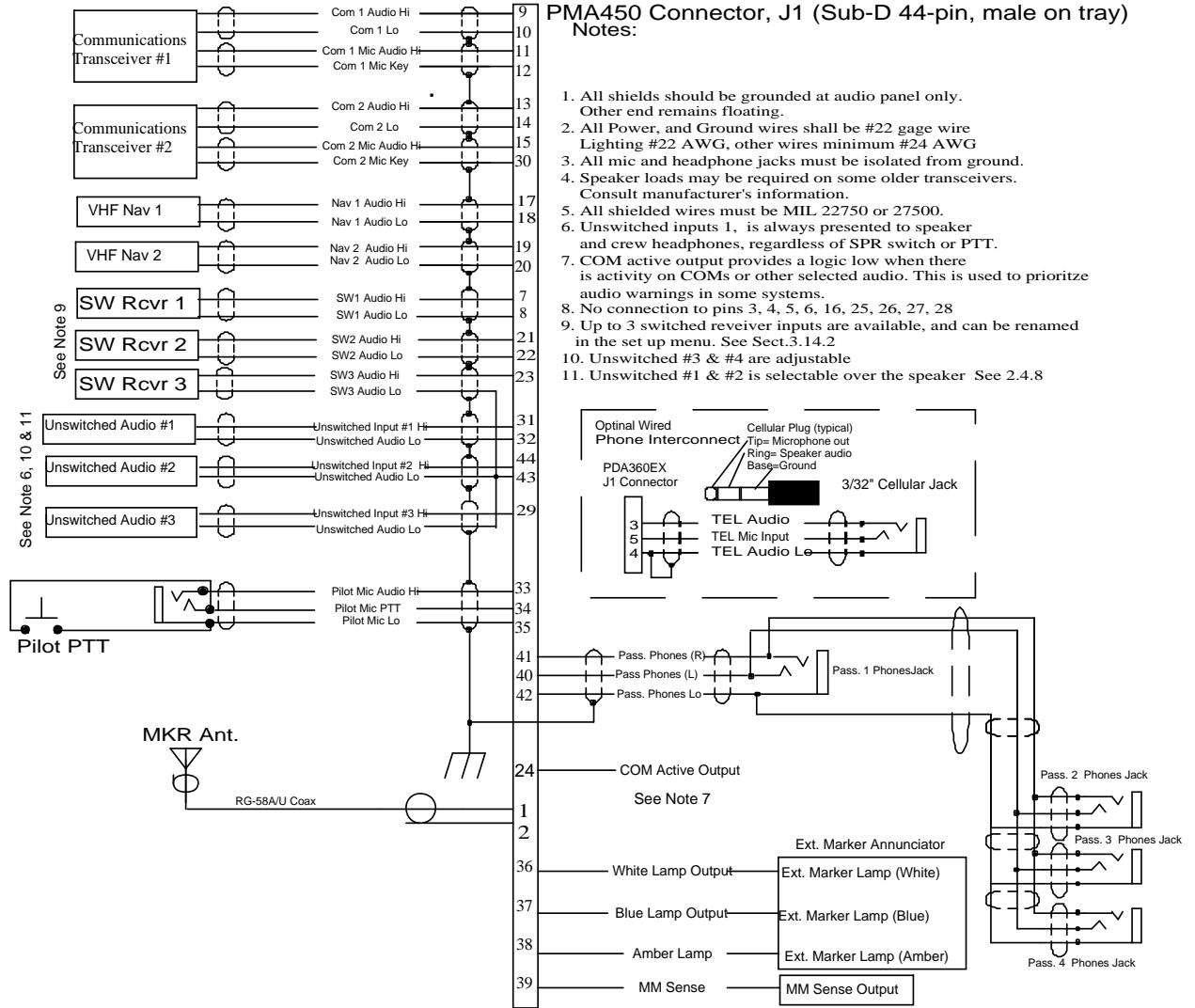

Appendix C – J2 Connector Interconnect

